

THE SCIENTIFIC MONTHLY

Edited by
J. MCKEEN CATTELL, F. R. MOULTON AND
WARE CATTELL

VOLUME LIV
JANUARY TO JUNE

NEW YORK
THE SCIENCE PRESS
1942

Copyright, 1941
THE SCIENCE PRESS

THE SCIENCE PRESS PRINTING COMPANY
LANCASTER, PENNSYLVANIA

THE SCIENTIFIC MONTHLY

JANUARY, 1942

REPAIR AND RESISTANCE OF TISSUE IN LIFE PROCESSES¹

By Dr. WM. deB. MacNIDER

KENAN RESEARCH PROFESSOR OF PHARMACOLOGY AND DEAN OF THE MEDICAL SCHOOL,
THE UNIVERSITY OF NORTH CAROLINA

THE life processes operating in and through tissues are being shown by experimentation to be dependent upon both highly specific as well as generalized chemical influences. These specialized chemical actions may become effective at such a high magnitude of dilution that their chemical measurement or assay assumes difficulties unless this measurement be indicated by some quantitative functional expression. Chemical and physical changes in the gross have lost their significance and attraction as through research the importance of the infinitesimally small has been appreciated. For example, the stimulation of nerve tissue, such as that of the vagus nerve supplying the heart with a portion of its fibers, is now known to exert its slowing influence, not by the action of some ill-defined nerve impulse effect, whatever this may be, but to the liberation as a result of the stimulation of a highly specific chemical body effect in a dilution of high degree which is responsible for the cardiac influence. A similar statement may be made for the stimulation of certain nerves which accelerate the heart. We pass from the gross and apparent of nerve stimulation

to the meticulous and specific in terms of chemical action.

The amazing influence of vitamins and the different components of a specific vitamin, illustrates not only the specificity of chemical action for a given tissue, but may include a more generalized tissue influence. The use of nicotinic acid in pellagra is perhaps the most astounding example of the generalized influence of a chemical on tissues when these tissues are attempting to live with a deficit of a chemical body having a common action for a variety of living and damaged cells. In pellagra the bilateral and characteristic skin lesions of the hands and forearms rapidly subside, the acutely inflamed tongue and mucous lining of the mouth become normal in appearance, the exhausting symptom, diarrhoea, subsides and finally this simple chemical body, acting in or on brain cells, may in a few hours transform a senseless, maniacal individual into one with sense, and sense with reason. Pharmacology, operating through physical and organic chemistry as that biological science which concerns itself with the chemical and physico-chemical action of substances other than the usual food materials in normal and also in pathological tissues, has a domain of very great importance in attempting to eluci-

¹The first of a series of three articles on "Tissue Susceptibility and Resistance" to be contributed by the author.

date the mechanism of chemical action, both in normal tissue as adjusted life and in diseased tissues as maladjusted life. Such a position of importance for this science in the medical curriculum has in no small way been due to the medical school of the University of Michigan, for here the labors of Abel, Cushny and Edmunds were of such an order of understanding as to create not only a body of facts but ideals translated through facts as pharmacology which have extended themselves far beyond the confines of this campus.

The function of pharmacology is not only to acquire highly specialized information as to chemical, drug action, in normal tissue but to obtain knowledge of this same type of action in pathological tissues attempting to operate under the strain of disease. The object of such inquisitiveness is two-fold. First, through research to obtain facts as isolated and detached as these facts may be, and secondly, certainly from the medical student's point of view, to be able to apply these facts for the modification of maladjusted physical states in the hope that such changes may be induced in tissues which will enable them to relate themselves to that environment in which they must at least attempt to function. The difficulty of such investigation is apparent. Even for normal tissues with a knowledge of the constitution of the chemical to be used in the reaction, our understanding of the chemistry of the living stuff in which such a chemical body is to act is extremely limited. It is as though we placed in a test-tube or beaker a chemical substance of known structure and then superimposed on it a body of unknown composition, watched the reaction in the gross and then attempted to explain its chemical detail. Such difficulties become greatly increased when we attempt to explain chemical action in pathological tissues, tissues that have departed from the normal through

processes of degeneration, but which may through chemical and physico-chemical developments either so recuperate or repair themselves physically and chemically that states of normal susceptibility, increased susceptibility or an acquired resistance to injury may develop within them.

As life flows on in cells and in similar aggregates of such units designated organs, processes of molecular disintegration and of synthesis go on in a more or less balanced relationship. These processes give rise to certain manifestations of cell life designated function. A state of imbalance in these forces not infrequently arises as a result of changes developing within such units as produced by chemical action from without on such units which lead to changes of such a gross order that they may be microscopically recognized and as such are designated changes of degeneration. Whether or not such changes going to such a point as may be determined by the nature of the cell are entirely harmful, or whether they may serve to modify and repress function and induce rest, is an interesting question, which will be considered later. We in our arrogance at least assume that such changes are harmful and that they should be made to return to what we consider the normal as early as possible. This may not be wisdom. In such injured cells with a modification of function there is likely an inherent urge within them to reconstitute their structure. We know little chemically concerning the degenerations. Our knowledge of the chemical processes indicating an attempt at reconstitution is virtually lacking. Whatever may be the chemical nature of these latter changes they are indicated in their development either by cell recuperation or cell regeneration. In the former process the cells return to a morphological normal without the formation of new cells. In the latter type of repair new cells are

formed by cell division to take the place of those units so severely injured that changes of recuperation have become ineffective as a process of repair. The factors determining what form of repair process will be instituted are impossible to state. The type of cell, its location, the severity of the injury and the age of the animal in which both the injury and the repair state develop have to do with these changes. Furthermore, it is not known what determines the physical integrity of such cells of repair to subsequent injury except in a very gross manner in that, if the injured cells by employing either process of repair or a combination of the two processes returns to the morphological normal for this cell type, there is usually no evidence of an acquired resistance. The repaired cell's chemical affinity for injurious chemical agencies has not been altered. If, however, the repair process leads to a morphological alteration in cell type, which type still possesses a certain degree of function normal for it, the chemical constitution of such repaired cells or newly formed cells may be of such an altered chemical nature as to withstand deleterious chemical action.^{2, 3, 4, 5, 6, 7}

The susceptibility of tissues to injury, the type of the injurious process in terms of its severity and chemical nature depends to an extent on the concentration of the toxic chemical substance and the affinity which a given cell type has for it. One of the radioactive elements, uranium, used in the form of the nitrate has the ability to injure epithelial tissue such as is found in the liver and in the kidney. In the liver this injury is of a

² Wm. deB. MacNider, *Jour. Exp. Med.*, 49: 387, 1929.

³ *Ibid.*, *Jour. Exp. Med.*, 49: 411, 1929.

⁴ *Ibid.*, Harvey Society Lectures, 24, 82, 1928-29. The Williams and Wilkins Co., Baltimore.

⁵ *Ibid.*, *Science*, 73: 103, 1931.

⁶ Thomas Francis, Jr. and C. H. Stuart-Harris, *Jour. Exp. Med.*, 68: 789, 1938.

⁷ Thomas Francis, Jr. and C. H. Stuart-Harris, *Jour. Exp. Med.*, 68: 803, 1938.

diffuse order, affecting uniformly all the epithelial secretory cells of the organ. In the kidney the action of the poison is selective in that it picks out the epithelial cells of the proximal convolution of the nephron to exert its toxic influence. In the normal dog the severity of this action is determined in part, and only in part, by the dosage of the poison. When such animals are given 2 mgs of uranium nitrate per kilogram the kidney shows functional evidence of injury by the appearance of albumin casts and red blood cells in the urine, by a rapid reduction in the output of phenolsulphonephthalein in the urine and after an initial increase in the volume of urine, by a decrease which may progress to a transitory anuria. The reserve alkali of the blood is reduced and there is a moderate retention in the blood of urea, nonprotein nitrogen and rarely creatinin. Such animals usually recover and do not show evidence of a permanent kidney injury. If afforded nourishment, fluid and warmth a process of repair is accomplished with a return of normal kidney function. Perhaps we fail to appreciate the innate tendency on the part of tissues to repair themselves perfectly and to function with adjusted beauty.

The changes of degeneration in such kidneys consist in cloudy swelling of the epithelium in the proximal convoluted tubule, rarely vacuolation of the cytoplasm and an increase in stainable lipid material in such cells with a degree of nuclear injury which is variable. The brush borders of such injured cells disappear and the mitochondrial arrangement is different from that found in the normal cell. Within eight to fourteen days following an injury to the kidney from uranium of this degree of severity, a repair process has developed which results in sufficiently injured cells, in the formation by cell division of new cells identical in structure to the normal cell found in this location of the tubule. If

at such a period the animal be re-intoxicated with an amount of uranium nitrate similar to that used for the first intoxication, there is no evidence that this normal epithelium of repair has developed an acquired resistance to this substance. The newly formed cells participate in the same type of degenerative process which may be of a more severe order than that induced by the initial injury. The animals which survive affect such a survival in so far as the kidney is concerned by the formation of a normal type of epithelial structure. These experiments would indicate that an injury to renal epithelium of the order and magnitude indicated is insufficient to so upset the chemical constitution of such cells as shown by cell changes that they can not repair themselves true to form and with such a normal chemical nature to retain their affinity for the toxic expression of the influence of uranium nitrate.

In another series of animals an intoxication has been induced by the use of a larger amount of uranium nitrate, four milligrams per kilogram. A certain percentage of such animals succumb from a combined renal and hepatic type of death. Those animals which survive show from biopsy material obtained from the kidney a severer type of epithelial injury to the cells of the convoluted tubule than has been described for the first group of animals. In this latter, more severely intoxicated group, the changes in the epithelium extend from that of cloudy swelling and a coarsely granular degeneration to one of cytoplasmic necrosis associated with the accumulation of stainable lipid material as fused masses or droplets. The nuclear changes are variable and important. In some areas involving the space in the tubule normally occupied by from two to ten or more cells there may be not only a disappearance of the nuclei, but of cell cytoplasm as well. The basement membrane in such areas alone persists. In

other areas where cell damage is severe but not complete, fragments of nuclear material staining intensely are to be found within the preserved nuclear membrane. In such locations the injured nuclei are covered with cell substance. Such an order of tubular degeneration in association with the glomerular injury is expressed functionally by a marked reduction in urine formation or an anuria, a high percentage of albumin in the urine as the state of anuria is approached, numerous fragments of granular and fatty casts, glucose and ketone bodies. The urine usually fails to show the presence of phenolsulphonaphthalein, while the blood indicates a high degree of retention of blood urea, nonprotein nitrogen and in the more severely injured animals a retention of creatinin. Recovery is variable and prolonged in such a group of severely intoxicated animals. The use of glucose and warmth appear to facilitate this process. In such animals as effect a recovery, the changes of repair in so far as the renal tubules are concerned is by a process of cell division, the newly formed cells arising from those cells which have been severely damaged but not damaged to the point of chromatic and nuclear dissolution. In such cells the first change is either a rearrangement of the chromatic material within the nucleus or its synthesis prior to cell division. These newly formed cells, arising as a repair process from severely damaged cells, are not of a normal order for this segment of the tubule. They are flattened, the nucleus is large in proportion to the enveloping cytoplasm and both nuclei and cytoplasm stain evenly and intensely. From such areas of new and atypical cell formation there occurs an ingrowth of such structures into those areas of the tubule divested of epithelial substance. This occurs along the course of the intact basement membrane. Such ingrowths are at first syncytial and may remain

syncytial. Usually such structures show perfect or imperfect cell differentiation. The length of such new cell formations is much greater than that of cells normal for this portion of the tubule. As this type of atypical cell repair is developing in the tubules, the glomeruli commence a process of periglomerular and intracapillary fibrosis. Such glomerular changes reflect themselves in terms of renal function. To date, in the mammalian kidney it is impossible to differentiate tubular and glomerular function except by inference.

The interest and significance of this atypical type of repair which may be induced in a kidney severely injured by uranium does not rest with the repair process alone, with the apparent reversal of this tissue through repair to tissue of an embryonic order. It assumes importance when the observation is made by secondary injections of uranium in the amount initially used, four milligrams per kilogram, or when this substance is even increased in dosage to six milligrams per kilogram that the altered atypical epithelium of repair is resistant to such degrees of intoxication, whereas epithelium of a normal order in the same location of the tubule was specifically and highly susceptible to this chemical agent. The experiments indicate that if this epithelial tissue be both severely and also sufficiently injured, the life mechanism in such injured cells is unable to effect an epithelial repair of a normal order. The repair process is of an abnormal, atypical order which partakes of certain embryological characteristics. Such a repair process imparts to these fixed tissue cells a high degree of resistance to subsequent injury. Life and resistant life perhaps of a lower order of functional effectiveness has been established as a result of cellular injury resulting through repair in a shift in cell morphology. Such changes are of a gross, structural order and it is not justi-

fiable to assume that the acquired resistance necessarily depends upon change of form. It must depend upon a change in chemical constitution which in these experiments has been associated with a shift in cell type. This thought is strengthened and for cells in general given a significance by the work of Bunting and Longley,⁸ which has shown that the rat kidney may develop a high degree of resistance to arsphenamine without a change in cell type, and by that of Selye,^{9,10} who has recently demonstrated an acquired resistance of the mouse kidney to bichloride of mercury following a protection afforded by the subcutaneous injection of testosterone. A resistance of the dog kidney to bichloride may be obtained following a repair of the kidney from a severe uranium injury.¹¹

Earlier in this discussion it was stated that the liver participated in a uniform type of epithelial injury when uranium nitrate was given subcutaneously. The following observations have been made concerning both the changes of degeneration in the liver and the processes of repair, which latter changes may not only afford the liver protection against uranium but also an acquired resistance to substances far removed in their chemical constitution from uranium.^{12, 13, 14}

The changes of repair which develop in the liver when an animal is intoxicated with different amounts of uranium need not be given in detail here, for the principles involved in these processes of repair are similar to those which have been given in detail for the kidney. A slight

⁸ C. H. Bunting and B. J. Longley, *Jour. Pharm. and Exp. Therap.*, 69: 171, 1940.

⁹ Hans Selye, *Jour. Urology*, 42: 637, 1939.

¹⁰ *Ibid.*, *Jour. Pharm. and Exp. Therap.*, 68: 454, 1939.

¹¹ Wm. deB. MacNider, *Proc. Soc. Exp. Biol. and Med.*, 37: 90, 1937.

¹² *Ibid.*, *Sciences*, 81: 601, 1935.

¹³ *Ibid.*, *Jour. Pharm. and Exp. Therap.*, 56: 359, 1936.

¹⁴ *Ibid.*, *Jour. Pharm. and Exp. Therap.*, 56: 373, 1936.

injury of a diffuse order to the liver induced by uranium is followed by repair accomplished by cell division in which process cells of a normal type are formed. When the epithelium is more severely damaged by a higher dosage of uranium and apparently damaged to a point which prevents a normal type of new cell formation, flattened and atypical cells, or syncytial structures, develop to in part or completely reconstitute the cords of liver cells which in large measure make up the liver lobules. If the repair to the liver has been accomplished by the formation of a normal polyhedral type of cell there is no evidence of an acquired resistance to subsequent uranium nitrate intoxications. If the repair has been effected by the formation of the atypical type of cell there develops not only an associated resistance to uranium, but to other chemical bodies usually possessing a marked hepatotoxic influence. Such resistance may not be permanent.

Chloroform is a chemical agent highly effective in its toxic action for the liver and elects to act in this capacity on hepatic epithelium in the central portion of the liver lobule. In this location it is able in a properly prepared animal to induce an epithelial necrosis with fatty degeneration in contiguous areas of the lobule. Many years ago the fact was demonstrated by Whipple and Sperry¹⁵ that if a dog was starved for twenty-four hours and given chloroform by inhalation for one and one-half hours, a central necrosis of the epithelium of the liver lobule invariably occurred. In the experiments now to be presented two groups of animals were employed to ascertain whether or not, following a uranium intoxication, the liver had acquired a fixed celled resistance to this certainly acting hepatotoxic agent, chloroform. The first group of dogs were represented by those animals that had recov-

ered from a moderately severely uranium intoxication, and which had effected a liver repair by the formation of a normal type of epithelium. When such animals were starved for twenty-four hours and given chloroform by inhalation for one and one-half hours they invariably developed a central necrosis of the liver lobules which was variable in its extent. The second group of animals was represented by those dogs which had recovered from a much severer uranium intoxication and which had from a study of biopsy material from the liver repaired this organ by the formation of the flattened and atypical, yet functionally effective form of epithelium. When animals of this group were starved for twenty-four or even forty-eight hours and given chloroform, not for one and a half hours, but for as long a period as three hours, the morphologically altered and atypical epithelium was found to maintain a structural resistance to the toxic action of this certainly effective agent, chloroform, when used in animals with a normal type of hepatic epithelial tissue. Such cellular resistance may not be of an absolute and permanently continuous order. These atypical cells are living units and likely even in their altered form and chemical constitution they have, through this life, evolved over long periods of time the urge to assume their normal form and normal chemical constitution. Such thoughts find substantiation from two sources. If animals possessing such atypical cells which have demonstrated their acquired resistance be subjected to a period of starvation for forty-eight hours and be then exposed to the action of chloroform for periods of three hours on two successive days, the early changes of hepatic injury develop in the central portions of the liver lobules. And furthermore, a certain number of these animals that have shown persistent epithelial resistance may after a period of months fail to show it in certain re-

¹⁵ G. H. Whipple and J. A. Sperry, *Bulletin Johns Hopkins Hosp.*, 20: 278, 1909.

stricted areas of the liver lobule. These are areas in which a reversion to a normal cell type has occurred and it is assumed with such a change in form a change in chemical constitution has also developed which renders such normal epithelium once more susceptible to the toxic action of chloroform. In areas in the same liver lobules in which no reversion of cell type to or towards the normal has developed, the atypical epithelium retains its acquired resistance.¹⁶

SUMMARY

1. This presentation concerns itself in the first place with an acknowledgment of our lack of knowledge of the chemistry of living tissues and therefore, even though we may have exact understanding of the chemical structure of a body introduced into such tissue, we may experience great difficulty in explaining how such a substance acts in normal tissue and even greater difficulty in grasping its mode of action in pathological tissue.

2. Such a concept may be demonstrated experimentally. Observations have been presented in connection with cell injury and repair to both the kidney and the liver that epithelial cells in the proximal convolution of the nephron and such cells in the liver as a whole have such a chemical constitution as to render them susceptible to the toxic action of uranium nitrate. When such cells in these two organs undergo repair, this process may result in the formation of morphologically altered types of cells and cells which afford some evidence of a

¹⁶ Wm. deB. MacNider, *Jour. Pharm. and Exp. Therap.*, 59: 893, 1937.

change in their chemical nature. These structures have not only acquired a resistance to the chemical agents which induced an injury to be followed by the altered cell type formation, but to chemical bodies entirely different in constitution from that body which through injury developed cell resistance. Cell repair effected by a normal type of cell formation and in the liver with a normal degree of function has no resistance to these injurious agents.

3. These observations should be considered of a very superficial and gross order and their significance should not be overshadowed and dominated by a morphological concept of resistance due to change in form as such. Cell form may be an associated, but not the significant factor in this type of acquired tissue resistance. Through changes in cell form the influence of physical forces may be modified which influence cell life by acting as such or which at the same time influence the readiness with which chemical bodies enter cells and also the ease with which they escape from such units. Such changes in cell form may in part determine chemical concentration within cells. Of more importance than a consideration of form is an understanding of the shifts in the chemical nature of cells when through a process of repair they either acquire or fail to develop a resistance to chemical substances. Research, not only of a pharmacological, but of a broad and fundamental biological order is necessary in this domain of fixed cell susceptibility and acquired cell resistance.

BAD EARTH

By Dr. SAM F. TRELEASE

PROFESSOR OF BOTANY, COLUMBIA UNIVERSITY

POISONOUS wheat and corn grown on fertile soil were virtually unknown to the scientist as well as to the general public until about seven years ago. At that time it was announced that grain from certain sections of the great cereal-growing region of the north central plains harbors the cause of a serious and sometimes fatal disease afflicting livestock and perhaps also man. We learned that farm animals get the disease from eating hay and grain raised in the affected areas, and it was intimated that flour and other mill products made from the grain might poison human beings.

Although little has been published on the subject until very recently, a serious disease of livestock has been recognized for many years by the inhabitants of certain parts of South Dakota and Nebraska. It came to be known as "alkali" disease because of a supposed relationship to alkali, or mineral salt, in the water or soil. The earliest account of the malady is to be found in a report written in 1856 by T. C. Madison, an army surgeon, who described the symptoms of a fatal disease that afflicted the cavalry horses at Fort Randall, then in the Territory of Nebraska but now included in South Dakota. He attributed the disease to the pasturage.

Marco Polo may have been referring to the same disease when he wrote, in about 1295, of a poisonous plant in Turkestan, which, if eaten by "beasts of burden," caused their hoofs to drop off.

A. T. Peters in 1900 investigated alkali disease in Boyd County, Nebraska, where it had been prevalent among all kinds of livestock since the settlement of that region in 1891. Although Peters erroneously concluded that only moldy corn

was responsible, he reported testimony of farmers which involved sound corn, other grains and pasturage. In a brief account of the disease in South Dakota, C. C. Lipp in 1922 stated that farmers were convinced that forage plants store a sufficient quantity of minerals to cause the disease.

In 1929 K. W. Franke, of the South Dakota Experiment Station, began a series of investigations which led to the discovery of selenium as the cause of alkali disease. His first publication on the subject, in 1934, demonstrated that grain raised on certain soil areas was highly toxic to animals. The next step was to discover, if possible, the nature of the poison. In May, 1931, at a meeting of an interbureau committee in Washington, H. G. Knight is said to have suggested that selenium be looked for in the grain. W. O. Robinson was furnished a sample of toxic wheat from South Dakota. He analyzed the wheat and in 1933 published a report stating that it contained minute concentrations of selenium—equivalent to only 12 pounds of selenium in a million pounds of wheat. Traces of this element were also found in soils producing toxic grain.

A preliminary field survey of alkali disease of livestock was published in 1934 by K. W. Franke and others. The survey included the regions from which this type of poisoning had been reported—namely, central and western South Dakota, northern Nebraska and the eastern edge of Wyoming. The native flora of the regions where the malady occurred was not observed to be different from that of adjoining areas.

Since the days of the earliest settlers poisonous plants have taken a heavy toll

of cattle and sheep throughout the vast grazing areas in fifteen of the western states. In many cases the identity of the plants responsible for the losses remained unknown for a long time. Even after demonstrating that certain plants were poisonous, state and federal investigators spent many years in futile attempts to ascertain the nature of the elusive toxic principle. To illustrate the magnitude of the losses, some examples may be cited: During the summers of 1907 and 1908 more than 15,000 sheep died in a region south of Casper, Wyoming, of acute poisoning attributed to woody aster and Gray's vetch. In 1930 about 340 sheep that had eaten two-grooved vetch died near Elk Mountain, Wyoming, within twenty-four hours. During the same year this plant caused the death near Rock River, Wyoming, of 125 sheep, 75 of which succumbed in a single night. In 1931 a flock of 200 sheep was pastured over night in a small gulch southwest of Pueblo, Colorado; in the morning 197 of these were dead. A year later 71 sheep, out of a flock of 157, died in the same gulch.

An outstanding feature of range poisoning is its restriction to limited but widely scattered regions, called poison areas. The most common causes advanced by stockmen to explain these poison cases have been alkalies and alkali water, poisonous gas arising from the soil or vegetation, and malicious poisoning by means of bad salt, bait or arsenic in the ponds. In an attempt to solve the problem, the Wyoming Experiment Station in 1921 drew up a project to study "an obscure disease of cattle on the range." Although the work continued until 1930, no evidence was obtained that could explain the cause of range poisoning in cattle.

The nature of the poison responsible for the wide-spread losses of cattle and sheep in the western states remained an unsolved mystery until O. A. Beath and his associates at the University of Wyo-

ming discovered in 1933 that certain wild plants on the ranges were able to absorb and accumulate large quantities of selenium when they grew on certain types of soils. Eight species of native indicator plants were found, the selenium content of which was definitely correlated with the geological formations on which they were collected.

In 1935 H. G. Byers began the publication of a series of reports on the occurrence of selenium in soils and vegetation.

The present article is based on a review of the literature, supplemented by observations in the field and in the laboratory.

THE ELEMENT SELENIUM

The chemical element selenium, discovered in 1817, resembles sulfur in chemical properties and reactions. In physiological action, however, there is a vast difference between the two closely related elements: sulfur is an essential constituent of all living substance, whereas selenium is as powerful a poison as arsenic, and it enjoys the unenviable distinction of being the only mineral element absorbed by food plants in sufficient quantities to make them lethal to animals.

Selenium occurs in many parts of the world. It has long been known to be associated with sulfur and to be present in ores of copper, iron and lead. Many rocks and soils of diverse origin have recently been shown to contain minute concentrations of this element. It is obtained commercially as a by-product of electrolytic refining of copper. About 100 tons of domestic and an equal amount of imported selenium are used annually in manufacturing processes. Selenium is used as a decolorizer in the manufacture of glass, and as a red or orange coloring matter in the production of glass, glazes, paint, ink and plastics. It is also employed in alloying steel and copper, in manufacturing rubber, in fire-proofing electric cables and in making photoelectric devices.

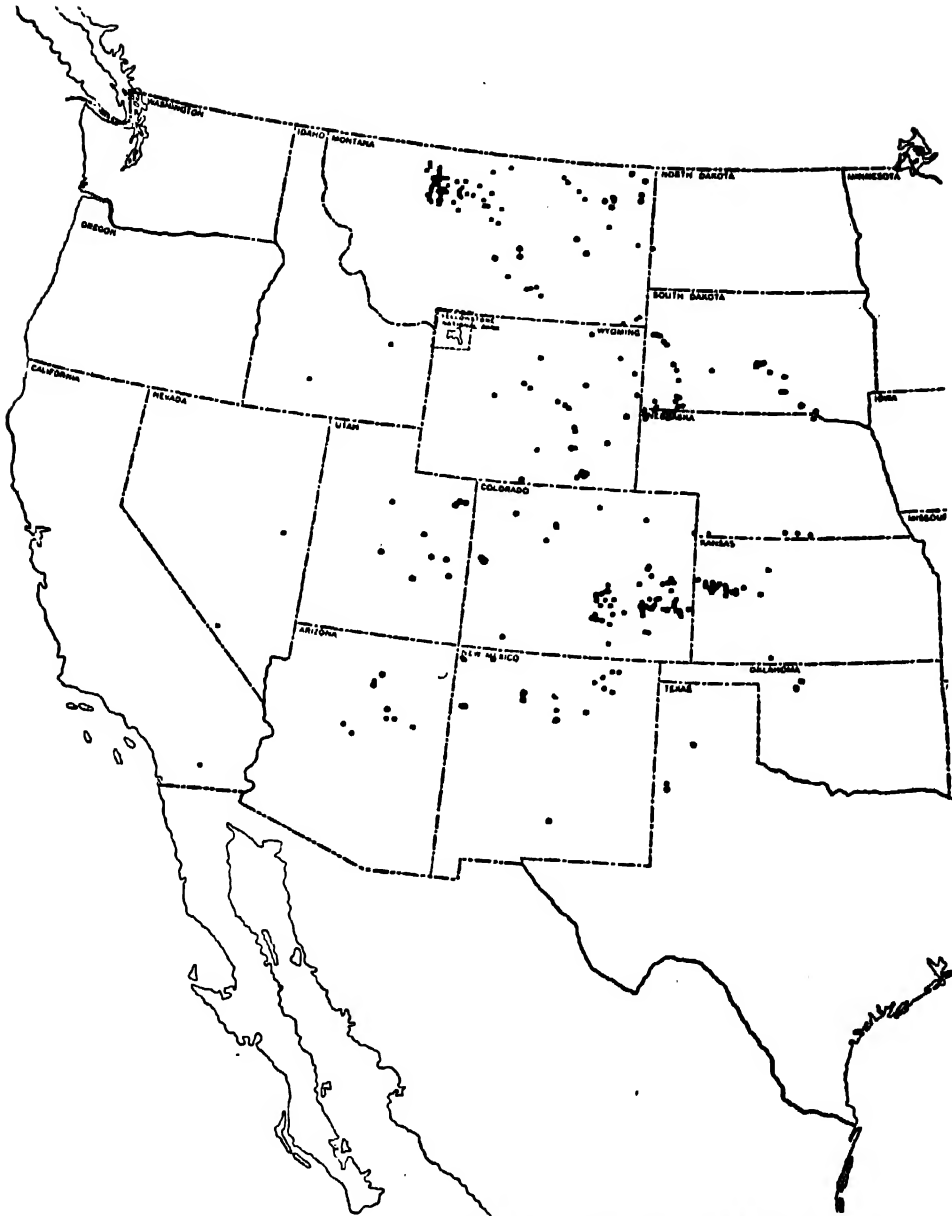

Base map copyright, American Map Co., Inc., New York

MAP SHOWING DISTRIBUTION OF HIGHLY TOXIC VEGETATION
 EACH DOT REPRESENTS THE PLACE OF COLLECTION OF A PLANT SPECIMEN CONTAINING MORE THAN
 500 PARTS PER MILLION OF SELENIUM.

NATURE OF SELENIUM POISONING

The form of selenium poisoning known as alkali disease manifests itself in horses, cattle and hogs by emaciation and stunted

growth. There is usually some loss of hair, particularly from the mane and tail of horses. The most striking symptom is deformity of hoofs, followed in

severe cases by the sloughing off of the old hoofs and the growth of a new set. Severely alkaliied animals die or have to be destroyed. In poultry the malady results in eggs that either do not hatch or else give rise to weak chicks with ruffled, wiry feathers.

The economic consequences have been disastrous in localities where the disease is severe. The raising of horses, cattle, hogs and poultry has been discontinued, and only tractor farming of small grain is carried on. Grain known to have been produced in certain districts must be sold at a discount, and diseased animals bring low prices when marketed. Owners of some of the farms have abandoned them, not being able to finance, lease or sell them. New renters, often uninformed of the conditions, have had heavy losses soon after moving to such farms.

It has been demonstrated by experiment that plants are able to absorb enough selenium from the soil to make them highly toxic to animals. A concentration of this element as small as 1 part (by weight) per million parts of the soil, added as sodium selenate (or selenite) or as a water extract of seleniferous plants, permits growth and maturation of wheat, barley and buckwheat, with no visible symptoms of injury to them. But when the grain or straw from these plants is added to a balanced diet and fed to white rats, it produces severe poisoning. Food containing as little as 5 parts per million of selenium derived from plants stunts the growth of these animals; 20 ppm in the diet brings about death in approximately six weeks; 65 ppm is lethal in about one week. Similar poisonous effects on rats have been observed when sodium selenite, instead of toxic plants, is added to the food. But for reasons not fully understood, inorganic salts seem to be somewhat more toxic than naturally occurring organic compounds, and they lead to less retention of selenium in the animal tissues. Nor has it been possible by administration of inorganic salts to

produce conspicuous malformation and sloughing off of hoofs of horses, cows and hogs.

Grain from farms with affected livestock has been used in extensive feeding tests on white rats at the South Dakota Agricultural Experiment Station. The grain includes corn, wheat and barley. Although the grain has no unusual odor or taste, it is poisonous to rats, producing anemia, liver lesions and other characteristic symptoms. The most toxic grain contained about 30 parts per million of selenium and produced very severe effects, bringing about death of 50 per cent. of the rats within 50 days, and 90 per cent. within 100 days. Less toxic grain caused death after a longer period of time; and the least toxic brought about only growth retardation.

When rats were given a choice between diets having various concentrations of selenium (natural or sodium selenite), they invariably chose the least toxic food, possibly basing their selection on taste or odor imperceptible to man. It is commonly believed by cattlemen that range animals are able to recognize the seleniferous vegetation (some of which possesses a telltale garlicky odor) and eat only the least toxic.

Most of the eggs from chickens fed on toxic grains develop deformed embryos and are incapable of hatching. Chicks from the few eggs that do hatch have down that appears greasy or wiry, and they live only a short time. Similar abnormalities can be produced by injecting selenium into eggs before incubation.

O. A. Beath observed in 1932 that specimens of the native wild plant *Astragalus bisulcatus* (the two-grooved vetch) growing in some soils had an extremely offensive garlicky odor, while specimens from other soils lacked this odor. In 1934 he demonstrated that the plants with the offensive odor were more toxic than those lacking it. The difference was found to be correlated with the

selenium content of the plants. This and related species are distributed throughout many of the western states, where they are responsible for heavy losses of cattle and sheep. The deadly nature of seleniferous weeds is shown by the fact that only ten ounces of green *Astragalus bisulcatus* rich in selenium will cause death in sheep in 30 minutes. These range plants sometimes accumulate more than 10,000 parts per million of selenium. They usually contain more of the element, and hence are more poisonous to livestock, when they grow on the Niobrara, Steele or Pierre shales than when they grow on certain other shale formations, such as the Morrison, Thermopolis or Lewis.

Two somewhat different types of selenium poisoning in livestock may be distinguished—namely, alkali disease and blind staggers. Alkali disease, known only in western South Dakota and northern Nebraska, is a chronic form characterized by loss of hair and deformation and sloughing off of hoofs. Blind staggers, the predominant form of the disease among cattle and sheep on the ranges throughout the western states, represents a much more acute type of poisoning, which results in death within a comparatively short period of time. There is no sloughing of hoofs or loss of hair in typical cases of blind staggers. Both diseases, however, seem to be produced by selenium and are characterized by the same type of injury to the liver. The differences in symptoms suggest that the various selenium-bearing plants carry the element in different chemical combinations, or that the selenium may be accompanied by other toxic substances.

When present in food, selenium finds its way into all the body tissues, attaining concentrations, according to H. C. Dudley and H. G. Byers, as high as 16 parts per million in the heart, 25 ppm in the liver and 27 ppm in the blood. A tolerance for the poison can not be acquired. Although selenium is eliminated

from the body in all secretions and excretions, it shows cumulative effects and produces permanent injury of the tissues. Selenium is carried in the blood stream to all parts of the body, but it is deposited chiefly in the liver, kidney and spleen (3 to 25 ppm). Concentrations of 8 to 20 ppm have also been found in the hoofs. Since the bile and the urine may contain as high as 5 to 7 ppm, excretion by the liver and the kidneys seems mainly responsible for elimination of selenium from the body. The urine of men employed in the extraction of selenium was found to contain from a trace to 7 ppm. A garlicky odor of the breath and other symptoms were noted.

Experiments with rats have shown that the toxicity of selenium (from inorganic salts or poisonous grain) is markedly reduced when the diet contains a very high proportion of protein, especially in the form of casein. But of course it would not be practicable to provide grazing livestock with such a diet.

According to A. L. Moxon, of the South Dakota Experiment Station, various arsenic compounds, supplied in the water or salt, tend to protect animals against the toxic action of selenium. Of great interest also is Moxon's discovery that the administration of bromo-benzene markedly increases the excretion of selenium in the urine and so helps the body rid itself of the poison. This detoxifying agent has recently been used with excellent results in the treatment of several cases of poisoning in man.

Loco disease is caused by alkaloids—not by selenium. A representative loco weed is *Oxytropis saximontana*. This plant usually grows on soils derived from granites, sandstones and volcanic ash. It sometimes grows on seleniferous shales, but rarely absorbs more than traces of selenium. When consumed in large quantities, it produces loco disease after about fifty days. Although the symptoms of loco disease are different from those of selenium poisoning, the two



RUINS OF THE CHAPEL AT FORT RANDALL, SOUTH DAKOTA
WHERE ALKALI DISEASE WAS FIRST REPORTED AFFLICTING CAVALRY HORSES IN 1856. THE CHAPEL
WAS BUILT OF SELENIFEROUS NIOBRARA LIMESTONE.

types of poisoning are frequently confused by cattlemen.

It is evident that a low concentration of selenium in foodstuffs is a quick-acting lethal poison for mammals. Some insects also are very sensitive to selenium. Aphids are killed by concentrations in plants too low to injure the plants themselves, and red spiders are quickly destroyed by commercial insecticides containing selenium. We were surprised, therefore, to find the larvae of tiny beetles (bruchids) and wasp-like insects (seed-chalcids) destroying our supply of seeds of one of the most poisonous of the range plants, *Astragalus bisulcatus*. A second wasp-like insect was present as a parasite of the seed-chalcid. Analysis of the seeds showed that they contained 1,475 parts per million of selenium. These insects were capable of completing their life cycles on food containing about seventy times the lethal concentration for mammals.

DISTRIBUTION OF SELENIUM IN SOILS

Seleniferous soils and vegetation have already been discovered throughout the western half of the United States, from North Dakota to Texas and west to the Pacific Ocean. The distribution of the selenium is not uniform throughout this area, since it is confined to outcrops of certain geological formations. The affected area extends to the north and south, into Canada and Mexico, but not to the east. Further investigation will probably show seleniferous soils in many other parts of the world.

In the United States, seleniferous soils are derived, for the most part, from rocks of the Permian, Triassic, Jurassic, Cretaceous and Tertiary systems. The age of the oldest is possibly 200 million years and of the youngest 50 million years. The selenium concentration is relatively high in the Pierre, Steele and Niobrara formations of the Cretaceous. Most of the Cretaceous shales were deposited in



A TOXIC PASTURE IN A WHEAT-PRODUCING SECTION OF SOUTH DAKOTA

a shallow sea that covered the present areas of the Rocky Mountains and the Great Plains. The selenium may have come from volcanoes that were active before and during the time when the shales were being deposited. Animal life during the Cretaceous was dominated by giant reptiles. Although ferns, club-mosses, cycads and conifers were abundant, there were also many kinds of flowering plants closely resembling forms known to-day.

Botany, geology and chemistry now provide the means of locating toxic areas. If seleniferous vegetation is found on a certain geological formation, we may predict with considerable accuracy its occurrence wherever outcrops of this formation appear. Detailed surface mapping of the outcrops capable of producing toxic vegetation would be a great help to farmers and ranchers, and this should be one of the first steps in the control of selenium poisoning in livestock and man.

The outcrops of shales usually carry

only 2 to 4 parts per million of selenium, of which very little is water-soluble. Soils derived from these shales may show an enrichment, which results in some cases from the solvent action of saline water and the drainage of soluble residues of selenium-bearing plants.

Seleniferous soils capable of supporting toxic vegetation are found in semi-arid regions, where the rainfall is insufficient to leach out the water-soluble selenium compounds. Cultivated crops do not significantly reduce the poison in the soil. Some of the soils that now produce toxic grain have been in nearly continuous cultivation for more than twenty-five years.

There is danger of adding selenium to soils through the use of insecticides or impure fertilizers, especially superphosphate and ammonium sulfate.

ABSORPTION AND ACCUMULATION OF SELENIUM BY PLANTS

The absorption of selenium by plants depends upon the nature and concentra-



CATTLE ON A POISONOUS RANGE IN WYOMING

tion of the compounds of this element present in the soil. Moreover, different species of plants exhibit striking differences in their ability to accumulate selenium.

Some soils that contain considerable quantities of selenium are incapable of producing toxic vegetation because the element is present in unavailable forms. Chemical analyses of soils, by present methods at least, do not reveal the amounts of available selenium and so can not enable one to predict the quantities that plants will absorb. If one wishes to ascertain the capacity of a certain soil to produce toxic vegetation, one must analyze the various species of plants growing on the soil.

When rooted in the same seleniferous soil, some kinds of plants do not absorb selenium at all, while other species accumulate large quantities. Cultivated cereals, native prairie grasses and many other forage plants on the ranges show relatively slight ability to take up selenium. But several wild composites (such

as the woody aster) and many species of *Astragalus* (vetches) accumulate it readily.

Selenium present in toxic grain was shown by Franke to be a constituent of the plant proteins. It replaces sulfur normally occurring in these substances.

Selenium is much less toxic to plants than to animals. Symptoms of selenium injury of plants have never been observed in the field, but dwarfing and other symptoms may be produced artificially by adding sufficient quantities of sodium selenite or selenate to the medium in which the plants are rooted. By means of water cultures and sand cultures, A. M. Hurd-Karrer and later A. L. Martin showed that the addition of an excess of a sulfate tends to decrease somewhat the absorption of selenium. This suggested that the application of sulfur to cultivated land might offer a practical means of preventing crop plants from accumulating toxic concentrations of selenium. But most of the naturally occurring seleniferous soils are



U. S. Department of Agriculture

THE CHRONIC FORM OF SELENIUM POISONING OF CATTLE

Left: COW AFFLICTED WITH ALKALI DISEASE. Right: DEFORMED HOOPS OF THE COW.

already saturated with sulfur in the form of gypsum, and field tests have demonstrated that the addition of more sulfur is ineffective in reducing selenium absorption.

SELENIUM INDICATOR PLANTS

It was discovered in 1933 by O. A. Beath and his associates that certain native plants always contain selenium when collected on seleniferous soils. These plants frequently accumulate large quantities, the highest so far recorded being 15,000 parts per million for a specimen of *Astragalus racemosus*. The selenium accumulators are known at the present time to include about 28 species of *Astragalus* (legumes with pea-like flowers) and all species so far examined of *Xylorrhiza* (woody aster), *Oonopsis* (a composite related to goldenrod), and *Stanleya* (prince's plume, of the mustard family). These plants are among the handsomest and most conspicuous of the western wild flowers.

Evidence from laboratory experiments, as well as from observations on the distribution of these plants in the field, tends to show that these species apparently require this element for their development and therefore can grow only on soils that contain it. Many of these species are abundant and widely distributed. They cover vast areas in the sparsely settled cattle and sheep sec-

tions of the western United States, and they are responsible for losses of livestock estimated at millions of dollars annually. *Astragalus racemosus* occurs from North Dakota and Wyoming southward to Texas and New Mexico. Other very widely distributed species are *Astragalus bisulcatus*, *Astragalus pectinatus* and *Astragalus pattersonii*. These are only the leaders among a horde of seleniferous species.

The indicator plants are an important aid in locating and mapping seleniferous areas, and they help the geologist find outcrops of certain formations. The mere presence of one of these plants indicates a seleniferous soil, and the high concentration in the plant is much more easily detected by chemical analysis than is the low concentration in the soil. Moreover, the selenium content of an accumulator collected on a certain soil gives a quantitative index of the capacity of this soil to produce toxic vegetation.

Since they give off volatile selenium compounds, these plants have a very offensive garlicky odor, the intensity of which varies with the amount of poison they contain. The odor of *Oonopsis* and of some species of *Astragalus* is so strong that it betrays the presence of the plants to one traveling in a rapidly moving automobile.

Among the selenium indicator plants, those belonging to the genus *Astragalus*

show the greatest diversity of form and the most extensive geographical distribution. This genus includes about 300 species in North America and 1,200 species in the rest of the world. Only the North American species have been examined for selenium. Field studies by Beath have shown so far that 28 of these species are selenium accumulators and indicators, whereas 54 other species absorb only small amounts of selenium and are not limited to seleniferous soils. The indicator species fall into 6 of the 29 groups into which the North American species have been divided on the basis of morphological characters. The 54 non-indicator species are found in 15 of these groups.

We grew two of the indicator species, *Astragalus racemosus* and *Astragalus pattersonii*, in solution cultures and sand cultures in the greenhouse. The development of these plants was greatly stimulated by selenium up to a concentration of 9 parts per million. In some tests, even 27 ppm were found to be stimulating, but 81 ppm were always toxic. It was impossible to deprive the controls entirely of selenium, since they received an initial supply from the seeds, but they made slow growth in comparison with that of the plants which received selenium in the culture solution. These experiments showed that selenium is a stimulating and possibly essential mineral element for the development of the indicator plants.

A totally different response was obtained with several of the non-indicator species of *Astragalus*, including *Astragalus crassicaarpus*, *Astragalus drummondii*, *Astragalus palans*, *Astragalus lonchocarpus*, *Astragalus carolinianus* and *Astragalus canadensis*. These species, when grown in artificial media, were not stimulated, but instead were poisoned by selenium. They were injured by one third of a part per million and killed by 9 ppm. In their response they resemble



TWO-GROOVED VETCH

Astragalus bisulcatus, ONE OF THE SELENIUM-BEARING RANGE PLANTS CAUSING HEAVY LOSSES OF CATTLE AND SHEEP. A HANDSOME PLANT WITH VIOLET FLOWERS AND TWO-GROOVED PODS.

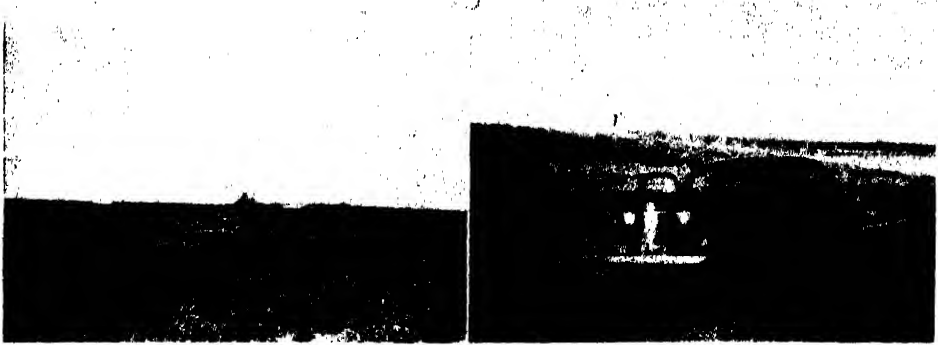

BAD WHEAT AND BAD LAND

Left: FARM PRODUCING TOXIC WHEAT ON PIERRE SHALE SOIL IN SOUTH DAKOTA. *Right:* OUTCROP OF PIERRE SHALE.

wheat, buckwheat, soybeans and tobacco. The poisoning manifests itself in plants by stunted growth followed in severe cases by death.

Chemical analyses of the plants in artificial culture brought out a marked difference in the ability of the two types of *Astragalus* to accumulate selenium. *Astragalus racemosus* was able to store more than 4,000 ppm without dwarfing or other injury. *Astragalus crassicaarpus*, in contrast, resembled wheat and other crop plants in being able to accumulate only relatively small quantities.

The greenhouse tests of growth in artificial media have confirmed field observations in showing a physiological differentiation of *Astragalus* species into two groups: those which require selenium for their development and so serve

as indicators of seleniferous soil areas, and those which do not utilize selenium. Incidentally, response to selenium is useful as a physiological character for classifying *Astragalus* species, and it provides a new approach to the construction of an evolutionary tree of the genus.

The non-indicator species of *Astragalus* occur on both non-seleniferous and seleniferous soils, since they are neither benefited by selenium nor poisoned by the low concentrations available in natural soils. Even when growing on seleniferous shales and in proximity to the selenium-accumulating species, they are free from selenium or contain mere traces. No clue has yet been found in attempting to explain these striking differences in the ability of closely related species to absorb and accumulate selenium.

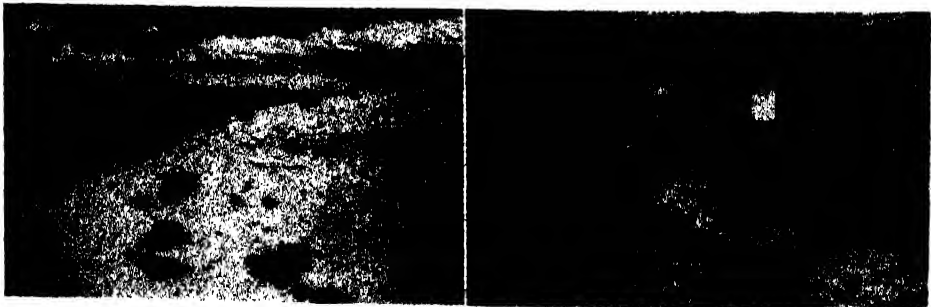

SELENIFEROUS NIOBRARA SHALE IN WYOMING

SELENIUM CONVERTERS

Native selenium indicator plants, according to O. A. Beath and his associates, play a very important part as selenium converters and soil contaminators. *Astragalus bisulcatus* and other selenium-accumulating plants absorb selenium from virgin shale soils, convert it into water-soluble forms, and return it to the soil in forms available for absorption by other types of plants, including farm crops. The organic selenium compounds of the converter plants may be extracted freely with water. Through the decay of foliage, seeds and roots of these plants, the selenium goes back to the soil in forms readily available to any type of

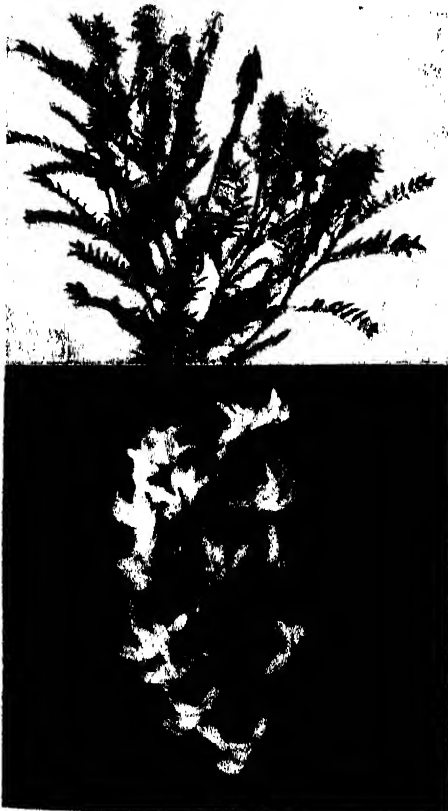

A SELENIUM INDICATOR PLANT
Astragalus racemosus. IT GROWS ONLY ON
SELENIFEROUS SOILS AND IS DISTRIBUTED FROM
NORTH DAKOTA AND WYOMING TO TEXAS AND
NEW MEXICO.



ASTRAGALUS BEATHII
A SELENIUM INDICATOR ABUNDANT NEAR THE
GRAND CANYON, ARIZONA.

plant. In some toxic regions accumulation of organic selenium in the soil may have gone on through countless cycles of growth and decay of the converter plants.

Plot experiments by O. A. Beath have shown that water extracts of *Astragalus bisulcatus*, if mixed with crude undecomposed Niobrara shale, enable barley, wheat and other farm crops to absorb toxic amounts of selenium, whereas these crops when grown on the same shale without the addition of the extract can absorb only traces of the poison. Most farm crops are almost certain to absorb dangerous quantities of selenium if sown on soil prepared by plowing under a heavy stand of native selenium-bearing plants.

Native grasses and other forage plants, when growing in proximity to selenium-bearing range plants, absorb enough selenium to make them poisonous to animals, but the same species of plants are essentially selenium-free when grown on uncontaminated shales.

In most farming areas the cultivated crops absorb little or no selenium, even though the soils contain some of the poison. The absorption of toxic amounts by farm crops is perhaps always dependent upon previous activity of converter plants.

Enrichment of the soil in available selenium progresses in a vicious spiral. Many of the most toxic farms are periodically abandoned, and while uncultivated they are overrun by converters that make them even worse than before.

Among the common fodders, alfalfa is noteworthy because it rarely, if ever, produces selenium poisoning of livestock. Chemical analyses of alfalfa cultivated in selenium-bearing shales show only traces of the poison. Even when alfalfa is grown on a plot that has previously borne a dense stand of seleniumiferous *Astragalus*, the crop usually is unable to absorb toxic amounts of selenium.

POSSIBILITY OF HUMAN INJURY

The selenium problem is of special importance because of the possibility of human injury from the consumption of grains, vegetables, eggs, dairy products and meats from affected areas. Extensive investigations into the poisoning of animals have already been made, but the research required on human phases of the problem seems barely to have been touched.

In 1936 M. I. Smith, of the U. S. Public Health Service, made a preliminary survey of some of the rural population in parts of South Dakota, Wyoming and Nebraska to investigate indications of selenium poisoning through the consumption of locally produced foods. A series of 111 families was studied for clinical evidence. Among 127 specimens of urine representing subjects from 90 families, 92 per cent. were positive for selenium and contained from 0.02 to 1.33 parts per million.

A more detailed study was later made of a selected group comprising 50 rural families in Lyman, Tripp and Gregory

counties of South Dakota and the adjoining Boyd county of Nebraska. This region had been found in the earlier survey to be highly seleniumiferous—as shown by the selenium content of the soil, the prevalence of alkali disease in livestock and the relatively high concentration of selenium in the human urine. The selenium content of 100 urine specimens ranged from 0.2 to 1.98 parts per million. There was little variation in the urinary concentration of selenium for the members of the same family or for the same individual at different times. This indicates that the excretion of selenium is a fairly reliable index of the hazard to which man is exposed. Aside from high incidence of symptoms pointing to gastric or intestinal disorder, neuritis and a few cases of apparent liver ailment, no other evidence of ill health was seen that could be ascribed to selenium with any degree of certainty. Many vague symptoms of ill health and some of a more serious nature were observed, but none was sufficiently characteristic to be ascribed definitely to the ingestion of selenium.

TABLE 1
MAXIMUM SELENIUM CONTENT OF FOODS FROM
FARMS

	Parts per million of selenium
Wheat	30.0
Corn	30.0
Rye	25.0
Onions	17.8
Barley	17.0
Oats	15.0
Asparagus	11.0
Eggs	9.1
Meats	8.0
Rutabagas	6.0
Cabbage	4.5
Peas and beans	2.0
Carrots	1.3
Milk	1.3
Tomatoes	1.2
Beets	1.2
Water	1.0
Bread	1.0
Potatoes	0.9
Cucumbers	0.6

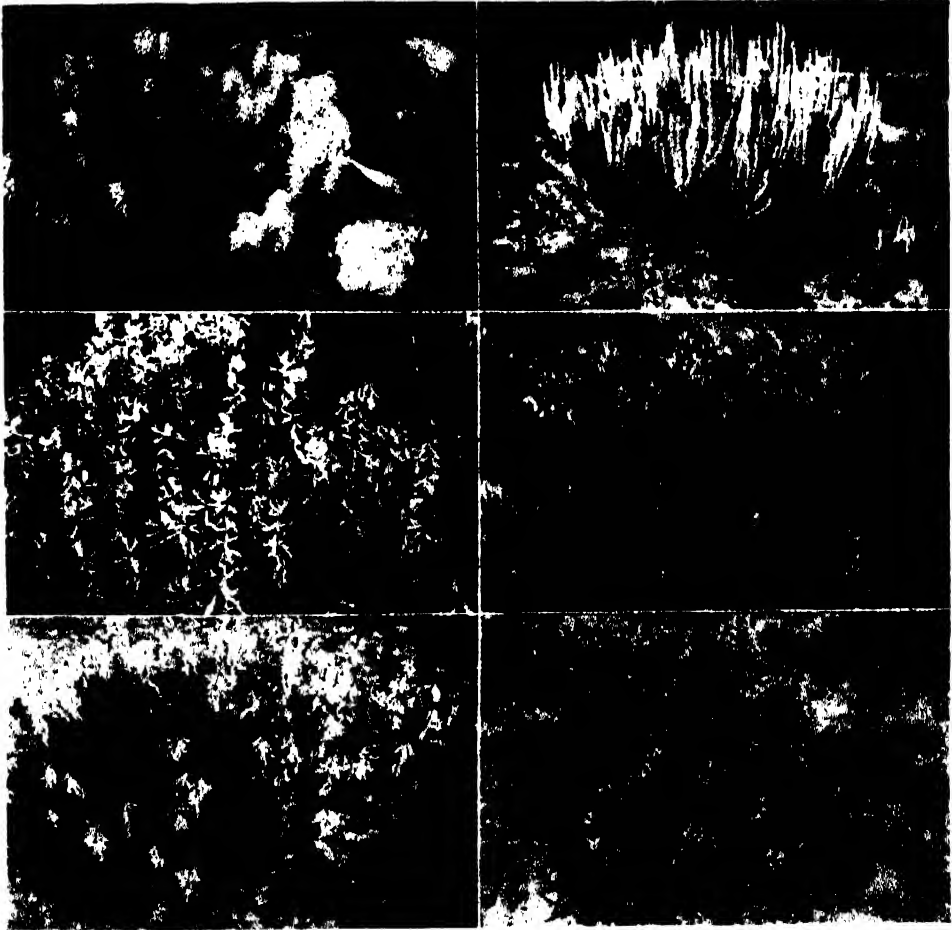

SOME SPECIES OF *ASTRAGALUS* THAT ACCUMULATE SELENIUM AND SERVE AS SELENIUM INDICATORS. Top: left, *Astragalus oocalycis*; right, *A. haydenianus*. Middle: left, *A. pectinatus*; right, *A. toanus*. Bottom: left, *A. pattersonii*; right, *A. grayi*.

In 1940 R. E. Lemley reported several cases of chronic dermatitis in South Dakota caused by the ingestion of seleniferous food. Administration of bromobenzene brought about a rapid increase in the elimination of selenium in the urine (as had previously been discovered by Moxon for selenized animals) and resulted in a marked relief of the symptoms. Bromobenzene is therefore of both diagnostic and remedial importance.

Table 1 shows the selenium contents of some foods from the seleniferous area. It is believed that a concentration of 5

parts per million in common foods, or one half a part per million in milk or water, is potentially dangerous.

Human injury might be more severe in the seriously affected areas if the inhabitants provided a larger fraction of their diet from their own produce. Few small mills exist, however, and the farmer sells his wheat and uses blended flour from Minneapolis or other distant milling centers. Relatively few vegetables are raised locally. Animal products, such as meat, eggs and milk, seem to be the most important and most constant

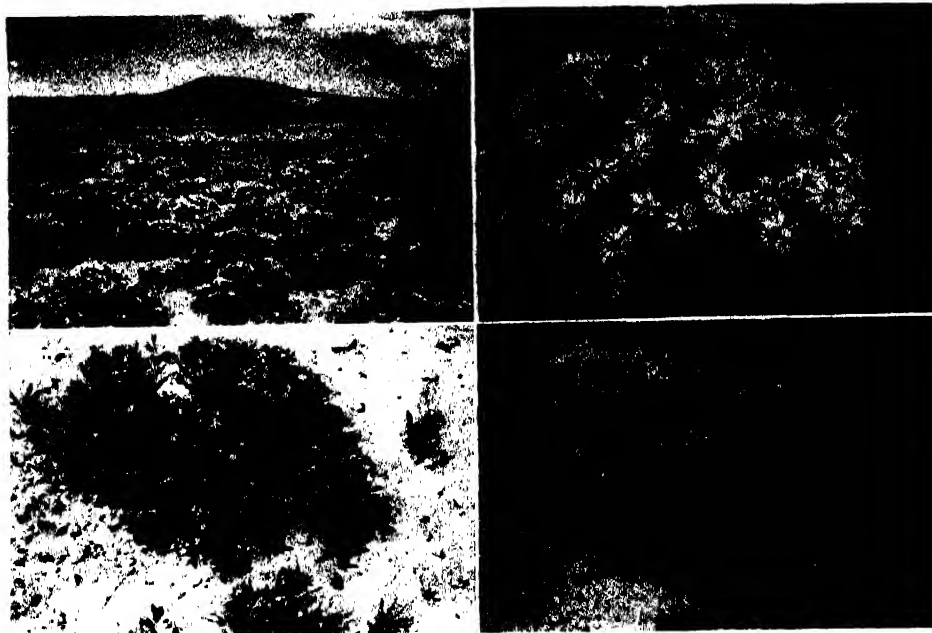

SELENIUM ACCUMULATORS AND INDICATORS

Upper: left and right, Xylorrhiza parryi (WOODY ASTER), WHICH, WITH ITS RELATIVES, COVERS THOUSANDS OF SQUARE MILES OF GRAZING LAND IN THE WESTERN STATES. *Lower: left, Oonopsis condensata*, A RELATIVE OF GOLDEN ROD; *right, Stanleya pinnata*, PRINCE'S PLUME.

source of selenium to which the inhabitants of affected areas are exposed. The question of the effects of selenium, in the quantities ingested, on the health of the local population has not yet been satisfactorily answered, but careful investigation may help account for some of the obscure ailments in the seleniferous areas.

Wheat is of special interest because of its use in bread and breakfast foods. The per capita consumption of wheat flour alone is about 160 pounds a year. The selenium content of 1,000 samples of wheat and wheat products from seleniferous areas was reported by K. T. Williams. The maximum content found was 30 parts per million of selenium. Only about 1 per cent. of the samples contained 10 ppm or more, and all these came from relatively small areas in South Dakota and northern Nebraska.

Approximately 95 per cent. of the samples showed less than 5 ppm. During the summer of 1940 we collected 21 samples of young wheat in Montana fields in which *Astragalus pectinatus* or *Astragalus bisulcatus* was found growing. Analyses by Beath showed that the wheat samples averaged only 1.9 ppm of selenium. Only one sample contained as much as 8 ppm, and this was in a field in which *Astragalus pectinatus* had 1,890 ppm. T. Thorvaldson and L. R. Johnson examined the selenium content of 230 composite samples made up of 2,230 individual samples of wheat from Saskatchewan, where highly seleniferous *Astragali* occur and selenium poisoning of livestock is known. The maximum amount of selenium found in the wheat was 1.5 ppm, this quantity being present in 10 of the 230 composites. The average for all samples was only 0.44 ppm. The

authors consider that the bulk handling of wheat for export would prevent the selenium content from greatly exceeding this average.

No serious attempt has yet been made to estimate the danger to public health outside the selenium area. The opinion has been expressed by several writers that even though highly toxic wheat is marketed, its dilution with non-toxic wheat and the small fraction which bread constitutes of the normal diet tend perhaps to render it harmless. But in the absence of exact information, nothing is to be gained by attempting to minimize the public health aspects of the problem. All foods derived from seleniferous areas should be analyzed and their course in the markets traced. Grains and meats, especially liver and kidney, in which selenium tends to accumulate, should be examined with special care. Public health surveys should be conducted in regions where seleniferous food is consumed, and physicians should be acquainted with methods for diagnosis of incipient poisoning. The problem is not confined to the United States, for selenium has been found in wheat from Canada, Mexico, Argentina, Australia, New Zealand, South Africa, Algeria, Morocco, Spain and Bulgaria.

Considerable hazard attends the use of selenium compounds as insecticides, since there is danger from even minute quantities of this element in soils on which food products are grown. Even spray residues ordinarily considered innocuous may be made available to the plant and be accumulated in toxic amounts.

CONTROL AND PREVENTION

It is evident from the preceding discussion that much more research work will need to be done before adequate methods of control and prevention of selenium poisoning can be applied. The following control measures may be suggested.

1. Seleniferous areas producing toxic vegetation should be located and mapped. Suspected areas should be carefully studied. Both the actual toxicity of the vegetation and the capacity of the soil to produce toxic vegetation need to be considered. If the native forage plants are largely grasses, the vegetation will be relatively non-toxic. But the same soil may be capable of supporting very poisonous woody aster, *Astragalus*, etc.

2. Areas known to produce toxic grain and forage should be immediately withdrawn from cultivation or grazing. Because of its reputation as a toxic area, a tract of 100,000 acres in South Dakota has already been withdrawn by the government from wheat cultivation.

3. Studies should be made of toxic limits and tolerance limits, diagnostic symptoms and remedial measures for selenium poisoning in man and animals.

4. Tolerance limits of selenium in food

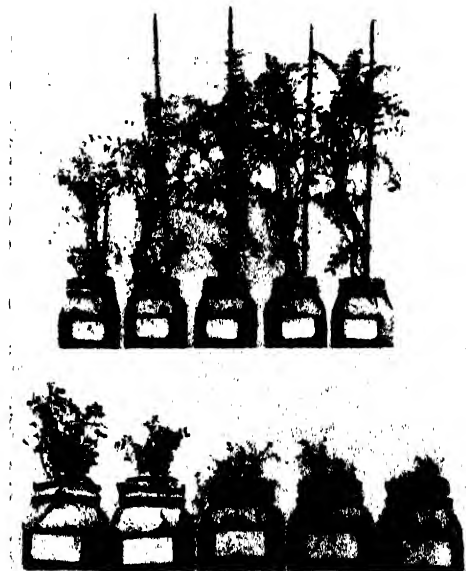

OPPOSITE EFFECTS OF SELENIUM ON TWO SPECIES OF *Astragalus*. Above: *Astragalus racemosus* STIMULATED BY SELENIUM. Below: *Astragalus crassicaarpus* POISONED BY SELENIUM. SELENIUM CONCENTRATIONS IN CULTURE SOLUTIONS (left to right): 0, $\frac{1}{4}$, 1, 3, 9 PARTS PER MILLION.

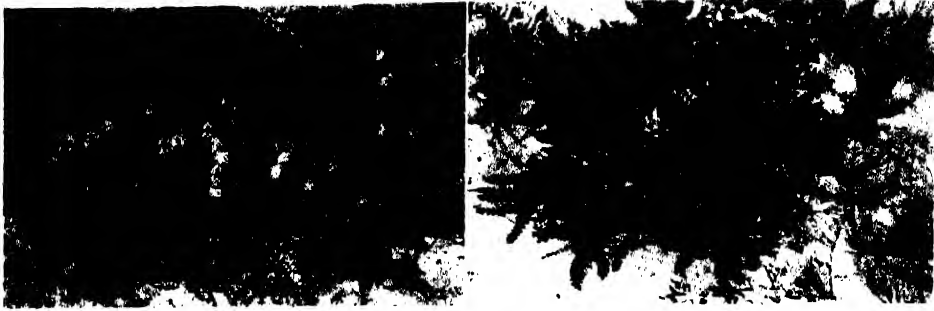

ABSORBERS AND NON-ABSORBERS OF SELENIUM IN SAME GENUS

Left: Astragalus carolinianus IN THE FOREGROUND IS UNABLE TO ABSORB SELENIUM FROM A SELENIFEROUS SOIL, WHEREAS *Astragalus bisulcatus* IN THE BACKGROUND ABSORBS ENORMOUS QUANTITIES OF SELENIUM. *Right: Astragalus crassicaarpus*, ANOTHER SPECIES THAT IS INCAPABLE OF ABSORBING SELENIUM.

for man and animals should be established and enforced by government inspection. Toxic grain, vegetables and animal products should not be used for human consumption. Likewise, animals should not be allowed to feed on toxic pasturage, hay or grain.

5. Destruction of highly seleniferous native range plants and revegetation with forages which are not selenium accumulators may be practicable in some regions.

6. Over-grazing should be prevented, since scarcity of good forage tends to force animals to feed on the highly seleniferous vegetation.

7. Some forage plants, such as alfalfa, may safely be grown on mildly seleniferous soils.

8. Non-food plants, for industrial use, may be cultivated on seleniferous soils.

9. Drainage may serve to reduce the available selenium content of irrigated soils.

OTHER MINOR ELEMENTS

The poisoning of livestock and man through the consumption of selenium absorbed by plants from minute quantities in the soil is only one phase of the broad subject of the relationship of the mineral

elements to health and disease in plants, animals and man. During the past two decades we have come to realize that certain mineral elements are required in exceedingly small amounts by all living organisms. These microtrophic elements essential for life include iron, copper, manganese, zinc, iodine, boron and possibly cobalt, molybdenum, gallium and others. Like the vitamins, they are needed in infinitesimally small quantities. Yet deficiency or excess of even a single mineral element can lead to serious disease, in plants as well as in animals. Plants that have absorbed suitable quantities of these elements for healthy growth may nevertheless contain amounts that lead either to deficiency diseases or poisoning in animals that use them as food. Selenium appears to be needed by only a few plants; it is tolerated by other plants; and, as far as we know, it is toxic but never beneficial to animals or man. There is evidence that certain other elements, such as fluorine and arsenic, can have only deleterious effects. The role of the minor elements in health and disease opens a whole new field of intensely interesting research, having a vital bearing upon human welfare.

EVOLUTION OF AUSABLE CHASM

By **Dr. CHARLES E. RESSER**

CURATOR OF PALEONTOLOGY, U. S. NATIONAL MUSEUM

THOUSANDS of people visit Ausable Chasm in northeastern New York every year. Whether they stand on the rim and look into its depths, or climb down over the vertical walls, or walk along the trail in the chasm, or go down the swift rapids in boats, they all wonder how it came to be. The chasm is beautiful in the shadows of its depths, in its coloring, in the form of its rock ledges and in its moving waters. While the visitor is enthralled by this beauty, the question of its origin and history always crops up in his mind.

Ausable Chasm is the handiwork of the Ausable River. Its geological history tells a rather simple story and one that the visitor can read as he enjoys its beauty. Like the Grand Canyon of the Colorado, Ausable Chasm owes its origin chiefly to the cutting power of running water. No catastrophe was needed to cleave the deep gash of the chasm—merely time and water. Ausable River on its way to Lake Champlain, from the region of the higher peaks in the Adirondack Mountains, in its lower course met a happy combination of conditions which permitted the river to cut this extraordinarily beautiful canyon. None of these conditions is in itself unusual and none involves exertion of sudden great mechanical force. In fact any such event would throw down the loosely piled ledges of its walls and destroy the chasm.

the northern and eastern slopes of the Adirondacks also have canyons, but none is as beautiful as Ausable. We ask ourselves, Why not? The answer is that none of the other streams met the requisite elements all together. And what are these elements? First of all, there had to be a swiftly flowing river that found a sheet of flat-lying rock in its course, for vertical walls are not easily produced in folded or tilted beds, or in massive rocks. Moreover, the sheet of rock encountered had to be not only in a horizontal position, but composed of layers and blocks that could be removed in a manner to leave vertical walls. In the next place, this rock thus left by the river had to be of such a nature, both physically and chemically, that the walls should not crumble too fast. Finally, the geological history of the Chasm had to be long enough to cut the deep canyon and short enough so that time was insufficient for the weather to level down the walls to an ordinary valley profile. Fortunately the recent glacial period furnished these necessary limits to its geologic history.

There are, therefore, only four simple requirements: a swift river, flat-lying sedimentary strata for the river to cross, rock of the right sort to form the walls and limited time. None of these involves catastrophic action, nor is any one difficult to comprehend. However, when we put them all together, the geologic story of Ausable Chasm goes far back in the earth's history, and its story becomes long and intriguing.

WHY IS THERE AN AUSABLE CHASM?

Nearly all other streams flowing down

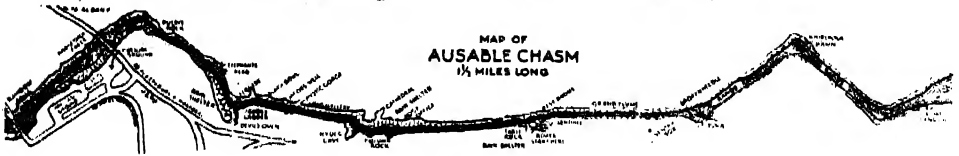

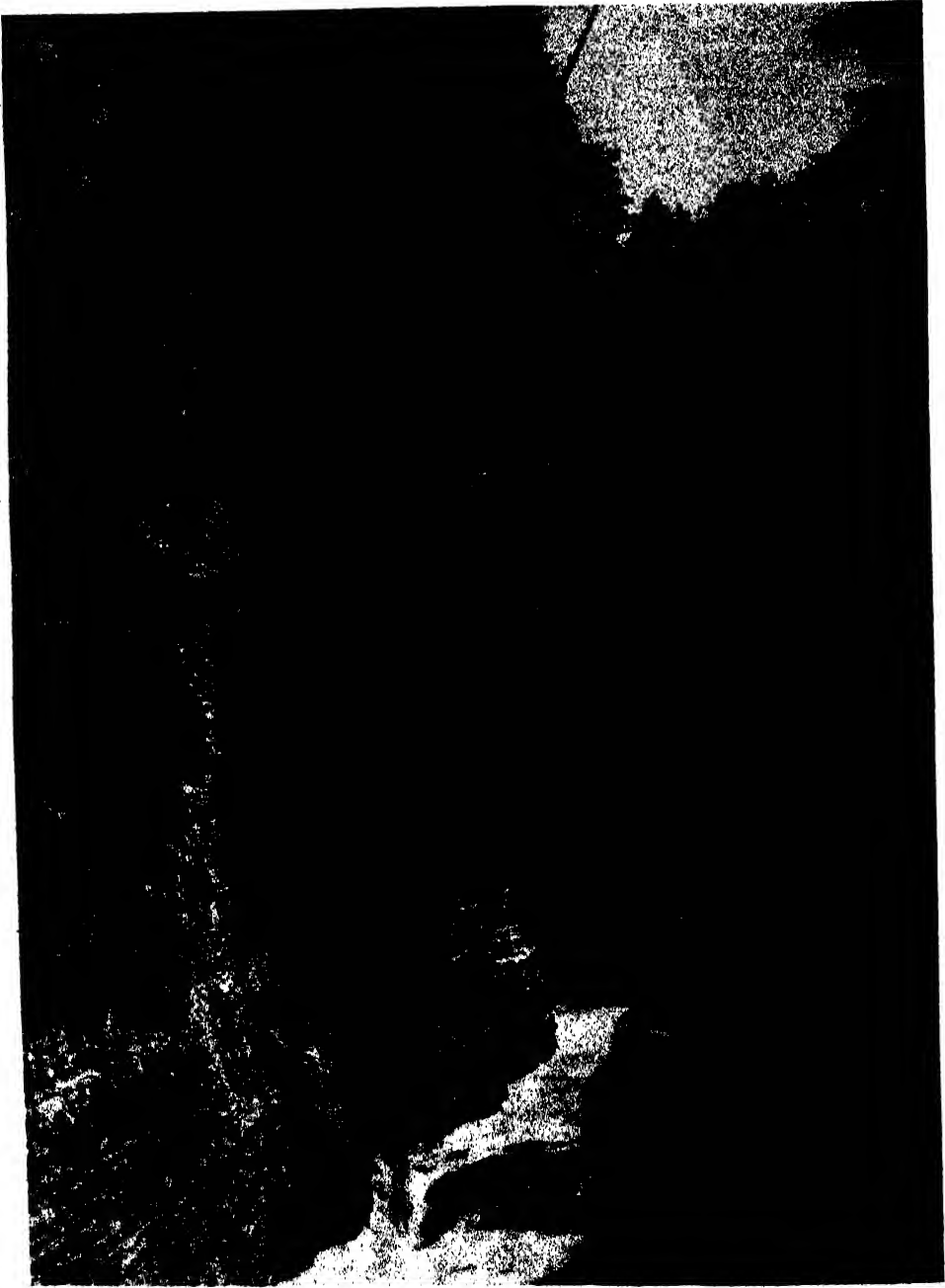

MUCH BEAUTY IN THE CHASM PRODUCED BY THE COLUMNAR ROCK STACKS
THOSE REPRESENT THE WALLS REMAINING BETWEEN THE LATERAL SLOTS.

The Adirondack Mountains are composed of some of the oldest rocks on the earth's surface. They attract many visitors by their ruggedness, which culminates in Mt. Marcy at an altitude of 5,344 feet above sea level. Ausable River rises high on the slopes of this mountain and empties into Lake Champlain, less than 100 feet above sea level. This means that the river must fall many thousands of feet in its course. Thus our first necessary condition, a swift stream, is met. As we go further in our description we will see that the river did not have such an easy time, but was pushed about by the ice of the Pleistocene Glacial Period.

The second condition has a far more complicated history. To-day the Adirondacks are a mountainous mass of ancient crystalline rocks standing above the surrounding valleys and lowlands. Hundreds of millions of years ago these same ancient rocks held a relatively elevated position. Of course, no geologist was there to see what happened, and the enormous length of time since elapsed naturally obscures details, yet it seems that during the Cambrian period what we now know as the Adirondack Mountains constituted a land mass surrounded by waters of the sea which had invaded the continent. Into these waters came rivers off of this island, carrying sand from the rocks exposed to the weathering. This sand was deposited in layers in the seawaters as it is to-day along all coasts. No doubt as time went on these streams and the waves along the shores gathered up enough sand to form a sheet of considerable but variable thickness all around the island. To-day we find fragments of this sheet along the northern and eastern flanks of the Adirondacks. These sediments, known as the Potsdam sandstone from the town of that name in northern New York, were deposited some 400 million years ago during the Upper Cambrian period.

The Adirondack Mountains have had a comparatively uneventful geological history, for this mass of ancient rock had a tendency to hold an elevated position through geologic time. Seemingly they formed an island during Cambrian times, and when the present elevation of New York and New England was attained they still stood above their surroundings. Their present altitude was reached by more or less vertical uplift, as in the region of the Grand Canyon and other plateaus of southwestern United States, and not by folding and buckling of strata, the process by which most mountain ranges are produced. For this reason the Potsdam sandstone never was folded, but it could not escape the vicissitudes of geological processes. These sediments have been broken by great cracks, called faults, along which blocks were displaced. They have been eroded by streams and scoured by glaciers, until to-day, as shown by the geological map of New York, the Potsdam and overlying strata cover only scattered patches along the flanks of the Adirondacks.

Thus was created the second necessary condition, a flat-lying sandstone sheet, in which a swift river could cut a box canyon. But already we see why we say a happy combination of conditions resulted in the formation of Ausable Chasm. Not only must there be the swift river and the sheet of sandstone, but somehow the stream's course must be directed across one of these small sandstone remnants.

If there is a swift river and a sheet of horizontal sedimentary beds with the river flowing in the right place, the next condition is that the rock must be of the proper sort to stand in vertical walls. This involves physical strength and chemical stability under the never ceasing attack of the weather.

The Potsdam sandstone in Ausable Chasm ranges in texture from a soft,

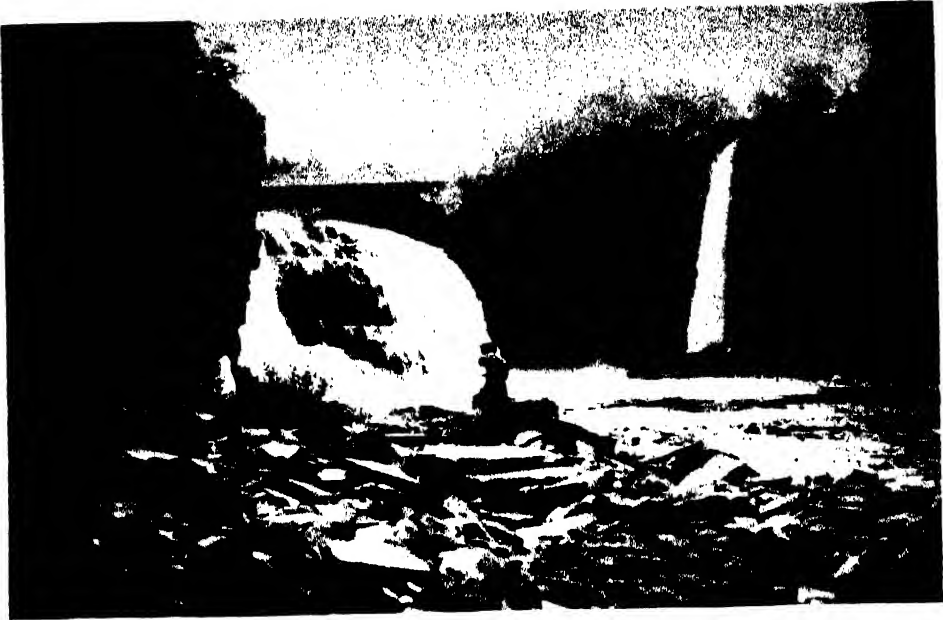

RAINBOW FALLS AT UPPER EROSION LEVEL AND HEAD OF CHASM
POWER USES CAUSE FALLS TO BE DRY EXCEPT AFTER RAINS.

friable sandstone to a hard, dense quartzite. Most of the rock consists of clean washed quartz sand cemented by silica, but some beds contain a little clay and other impurities, and at a few places the cement is calcareous. The photographs show how ledges are strong enough to support themselves where they project many feet from the walls. Except in the rare spots where calcareous cement was rather abundant, none of the constituents of this rock yield readily to chemical action. And so our third condition is met.

Now, we must find an agency to limit the life of Ausable Chasm, which is a young valley in the terminology of the geologist. Valleys have distinct characteristics at the various stages of their life, and in the course of time must disappear as erosion levels off the land. If time is too short the stream can cut only a short canyon; if too long ordinary weathering agencies will be able to break down the walls, giving us a valley with the normal

V-shaped profile. In the case of Ausable Chasm this regulation of time was supplied by the episodes of the recent glacial period.

The Adirondacks were well within the field of action of the great ice sheets that moved south from Canada. Coming down on the region from the north and northeast, the ice sheet had its advance opposed by the elevated mass of the Adirondacks and was forced aside by it into two great ice streams, which worked their way around the region. The one advanced up the St. Lawrence valley, then turned south along the west side of the Adirondacks. The other turned south through the Champlain valley. As the ice increased in thickness, it encroached more and more on the flanks of the Adirondacks, till finally it overswept the whole and persisted in this condition for a long time. While the basal currents of the ice continued to be controlled by the topography, the main mass swept over the whole region in a general south-

westerly direction. Changing conditions ultimately brought about recession of the ice. The thickness was least over the highlands, and the ice first disappeared there, leaving the two great ice currents sweeping round the region, as they did during the advance.

The final disappearance of the ice left the topography modified both by glacial wear and glacial deposits, and stream courses more or less modified. With such treatment after the millions of years of normal stream action, it is a wonder that any remnants of the Potsdam sandstone sheet remain to indicate its former presence and extent.

The whole region apparently was depressed while the ice was present and for a time after the ice had disappeared. At the height of the depression sea waters invaded the valleys of the region, penetrating Ausable River above the chasm to about Keeseville. This rather complicated series of events in the later history

of the region gave rise to the terraced topography one may see from an eminence. After this the whole region was elevated. This elevation amounted to about 800 feet at the north end of Lake Champlain, decreasing to zero south of New York City.

There possibly was an Ausable River before the ice covered the region, but if so it took another course. It was only after the ice sheet melted that the river began to flow in its present channel, and began the work of cutting Ausable Chasm. Because this event happened not very long ago, geologically speaking, time has been insufficient to break down or even seriously deface the Chasm walls. And so our fourth condition is met, and we may enjoy the great beauty of Ausable Chasm.

THE CUTTING OF THE CANYON

When the ice melted and Ausable River began to flow in its present course,



LOOKING DOWN FROM RAINBOW FALLS

SHOWS HIGHWAY BRIDGE AND UPPER STRETCH OF THE CHASM. SEVERAL SMALL FALLS REPRESENT OTHER EROSION LEVELS THAT HAVE NOT YET CUT BACK TO RAINBOW FALLS.



DAM AND FLAT ROCKS OF CHIASM ABOVE RAINBOW FALLS

THE DAM IS FOR POWER PURPOSES AND PREVENTS UPSTREAM MOVEMENT OF THE FALLS. WHENEVER THE RIVER LOOSENS A BLOCK WHICH THREATENS THE SAFETY OF THE DAM THE POWER COMPANY FILLS IN THE SPACE WITH CONCRETE; THUS IT INTERFERES WITH NATURE'S PROCESSES.

most of the sandstone sheet near Keeseville was intact, with the river flowing over it. Previously ice had filled Lake Champlain, and as it scraped its way southward cut back the spurs and piled up the deposits in the coves. In this manner terraces were created along the lake shore over which Ausable River flowed. Its lower course lay over some of these glacial debris, into which it rapidly sank its channel. To-day a steep-sided, V-shaped channel extends upstream through these deposits from the delta at Lake Champlain to the lower end of Ausable Chasm.

Rivers flowing down steep slopes do not usually cut their channels down evenly, but work hardest at the base of the slope. This causes rapids or falls which move upstream, leaving behind them vertical side walls. However, a stream seldom puts all its drop into one falls, but because of varying hardness,

placement of cracks or other accidental causes more than one falls and rapids develop. Each of the erosion levels thus developed moves upstream, more or less maintaining its respective height. In this manner Ausable Chasm was cut back from the lower edge of the Potsdam sandstone sheet to its present length. As long as the power dam remains above Rainbow Falls at the head of the canyon, no further headward erosion will be permitted. Meanwhile the secondary levels, the falls and rapids downstream, will continue their upstream movement until they join and increase the height of Rainbow Falls.

Let us now look at the detailed process of cutting. How the falls and rapids move upstream and leave behind them vertical side walls has already been explained, but the manner in which the rock is removed from the channel is still to be described.

Ausable River rises to considerable heights in floods, when large blocks of rock are rolled along in the channel. But even in the flood stages this river carries comparatively little sand and other débris. At normal stages the water is clear, a fact due to the presence of lakes in the upper course of Ausable River, which trap the sediments washed off the mountain slopes. As a consequence Ausable River does little scouring of rocks, the commonest manner in which streams cut their channels. So we must look for another means as the chief agency in cutting its channel. Before describing that process reference needs be made to the preparation of the sandstone for removal.

The Potsdam sandstone is bedded in thin and moderately thin layers. Variation in texture, quantity and kind of cement, and impurities present, permit the weather to loosen the layers along the bedding plane. The tectonic forces which affected the region put twisting stresses on the sandstone layers and developed several joint systems. Everyone has seen glass in a door or window which has been subjected to twisting strain and has observed how cracks are developed. The cracks follow a system, usually two roughly parallel sets at right angles to each other. If the glass were a cube instead of a sheet, more than two sets of cracks would be apt to develop. Such sets of cracks in rocks are called joints. In Ausable Chasm the bedded sandstone is jointed so that almost everywhere the rock can be taken out in more or less cubical or rectangular blocks.

Frost and other agencies have loosened many of these blocks which lie about everywhere, except in the channel swept by flood waters. Few of the blocks within reach of the water have corners or edges worn off, hence we know there has been little scour. Most of the channel cutting is done by removal of block

after block. This removal appears to be done only in part by the force of flowing water, but seems to be mainly a plucking process in which the water is assisted by ice. Ice freezes in the quiet reaches, and where the water passes over rapids the ice forms on the rocks. Late in winter ice forms great masses at these spots, and when the spring freshets come suddenly, the augmented flow of the stream picks up ice, rocks and all and carries them down toward the lake. Thus the cutting of the gorge goes on year after year, much faster than the clear water could cut its channel by scour or than the chemically stable sandstone walls would crumble under the influence of the weather. The rapidity of this process formed a long chasm since the ice age.

At some places, particularly in the Long Gallery and the Grand Flume, the Chasm walls stand particularly straight and smooth. This is due to the presence of master joints. Most of the joints run through one or several beds of sandstone.

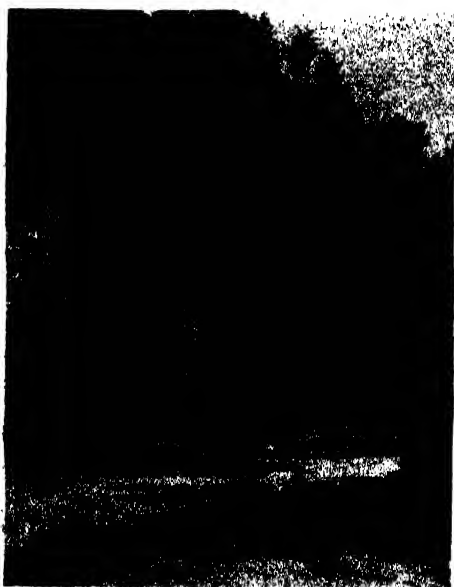

ELEPHANT'S HEAD
A COLUMN THAT IS RESTRICTED AT BOTTOM DUE TO
OBLIQUE VERTICAL JOINTS.



UPPER END OF DEVILS OVEN FAULT
A SHORT DISTANCE DOWNSTREAM FROM THE RIGHT-
ANGLE TURN BELOW HORSESHOE FALLS, WHERE
THE STREAM ENTERS THE FAULT WHICH DETER-
MINES ITS COURSE TO DEVILS OVEN. NOTE SLIGHT
OVERLAP OF STRATA ALONG FAULT LINE.

Occasionally a joint will extend across many beds, in fact at places the master joints run through several hundred feet of beds. When the river found one of these, it cut down rapidly and the resulting wall was so smooth that the weather had less chance to work on it.

Travelers frequently ask the question: "How many years were required to cut Ausable Chasm?" Geologists are not greatly interested, nor can they readily measure geological events in terms of years. They date earth history according to relationship of one event to another. For example, if there are two layers of sedimentary rock in normal position, the upper one is younger than the lower. Whether ten years or several thousand years are required to deposit either of the beds can not be determined readily, and it really makes little difference for geological understanding, as the

order of happening serves for most purposes.

Various attempts to arrive at some estimate of geological time in terms of years have been made. Most of the earlier attempts were unsatisfactory, but for this purpose it has been found that the disintegration of radium minerals can be relied on to a certain extent. For the more recent events, particularly those associated with the rather late ice age, other means are used. A method that gives a more or less definite determination of age in years is the counting of varves. Varves are fine layers of sediment in certain types of glacial deposits which are thought to represent the differing detritus of the winter and summer months, the latter having much more plant material, because of the growth of plants in the warm season. Another method employed to determine the years since the last glacial ice retreated is to estimate the time needed for Niagara



THE POST OFFICE
SOFT LAYERS OF ROCK PRODUCED BY LEACHING OF
CALCAREOUS CEMENT. THESE LAYERS CONTAIN
FOSSILS. TOURISTS PIN MESSAGES HERE.

Falls to cut back from Queenston to its present position, for it seems that the Niagara flowed in its present course only after the ice melted. Ausable Chasm is also postglacial and therefore comparable in age to Niagara gorge.

Estimates of the age of the Niagara gorge vary. Some put the time as short as 15,000 years, while others think it exceeds 35,000 years. It may thus be assumed that the Ausable River took at least 15,000 or more years to cut its chasm.

It will be observed that Ausable Chasm is not straight. From Rainbow Falls to the angle below the highway bridge the river follows a northwest course. It then turns nearly at right angles to a northeast course as far as Devils Oven. From there it holds a fairly straight course to the Pool, where it again follows the northwest course parallel with the sector below Rainbow Falls. Another right angle turn puts the river back on the

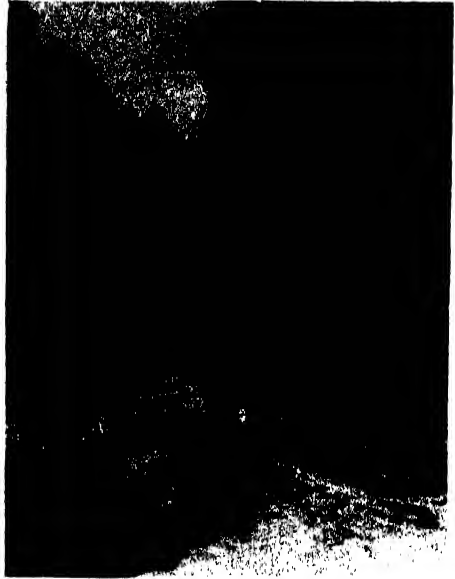

DOWNSTREAM FROM HELL GATE BLOCK AT LEFT HAS SLID DOWN AND AWAY FROM WALLS ALONG OBLIQUE JOINT. THE BEAUTIFUL AND HARDY FERNS GROW IN THE CREVICES BETWEEN THE BEDS OF ROCK. IMMEDIATELY BELOW DEVILS OVEN, WHERE THE STREAM LEAVES THE DEVILS OVEN FAULT.



DOWNSTREAM FROM DEVILS OVEN BETWEEN STEEP WALLS OF A CHASM CUT THROUGH MANY LAYERS OF ROCK BY RUNNING WATER ALONG THE LINE OF MASTER JOINTS.

northeast course again, and finally it swings back to its general line. Thus there are two more or less parallel sectors in both the northwest and northeast directions. These are due to cross faults.

A fault is a plane along which one portion of a rock mass has slipped with respect to its neighbor. In this manner it differs from a joint. Because there was movement, a fault must extend through more beds than even the greatest master joint, and consequently has more influence on erosional process. Thus the smoothness and straightness of the walls at many places is determined by the master joints, but the very course of the stream was affected by the faults.

A WALK THROUGH THE CHASM

We have seen why Ausable Chasm came to be, and how it was cut by the



SHOOTING THE RAPIDS

ONE OF THE EROSION LEVELS MOVING UPSTREAM. CONCRETE WALL BUILT TO DEEPEN WATER FOR BOATS WHICH GIVE TOURISTS THE EXCITEMENT OF SHOOTING THE RAPIDS.

Ausable River. Now it will be profitable to go with the visitor through the Chasm by trail and boat and read the simple lessons in geological history clearly portrayed in the walls and channel.

As the visitor goes down the steps at the entrance, the length of the stairs emphasizes the depth of the Chasm, and the verticality of its walls. To his left at the foot of the stairs is Rainbow Falls, the highest in the Chasm. If the visitor climbs on the ledges, which are bare except at high water, he will see fine examples of ripple marks, sun-cracks and trails. These can, of course, be seen at other places as he walks through the Chasm. The ripples were made by the waters of the Cambrian Sea in the sand as it was deposited, telling us of waves long ago. On the other hand, the sun-cracks show us that at times the bottom was laid bare to the sun long enough for the sand to dry out and shrink.

Two sorts of trails occur on the same surfaces. There is the broad trail known as *Climaticnites*, a name derived from its ladder-like appearance. The other is *Protichnites*, which consists of a thin line between small impressions, just as if some animal with many legs walked over the sea bottom and dragged a long narrow tail behind. What made these trails is an unsolved puzzle.

As the visitor passes under the highway bridge he comes to the Horseshoe Falls, the second of the erosion levels moving upstream. Beyond that he approaches a sharp right-hand turn of the river. If he looks across the stream at the turn, he will see that the strata are disturbed by a break along which there was some slipping. This is the western end of the Devils Oven fault, the line of which determines the stream course to

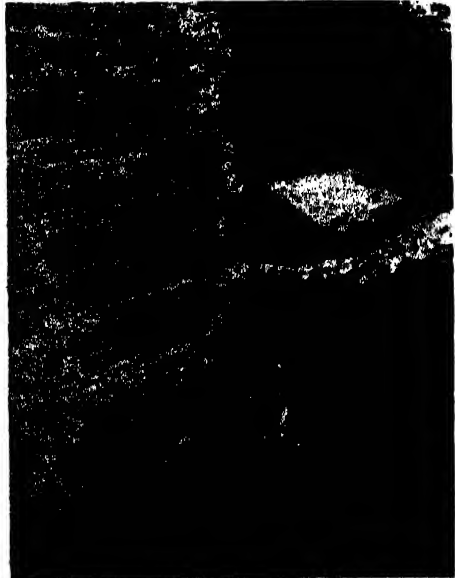

TABLE ROCK

BLOCKS DROPPED FROM RIGHT WALL MAKE CONVENIENT LANDING FOR BOATS. SINCE FLOOD WATERS RISE OVER 40 FEET, THE SHED MUST BE LIFTED ABOVE THEIR REACH. SLOTS PARALLEL TO RIVER REPRESENT OTHER CHANNELS FORMERLY USED WHEN RIVER WAS AT HIGHER LEVELS.

the Devils Oven. One of the first things noted below the turn is Pulpit Rock, and a little further along the Elephants Head. These are prominences left between deep slots cut back into the side walls.

The prominences which add so much to the beauty of the Chasm need no explanation, but the reentrants do. Why should these narrow, parallel-sided slots be cut back into the Chasm walls is a question often asked. Their straight sides naturally conform to master joints, the spacing of which determines their respective widths. Examination of the rock in these recesses invariably shows more thorough weathering than the same layers have suffered on either side. Due to this intensified weathering, the rock of the slot more readily falls down, and the stream carries away the débris. Ex-



LIGHT EFFECTS IN NARROW FLUME
THE OPTICAL ILLUSION OF A SLOPING WATER SURFACE CAUSED BY THE SLIGHT DIP OF THE ROCKS, AND THE QUIET WATER, IS ESPECIALLY NOTICEABLE LOOKING UPSTREAM.



DEPARTURE FROM THE FLUME
THE NARROWEST PART OF THE CHASM. ITS HIGH STRAIGHT WALLS ARE DUE TO MASTER JOINTS. SLIGHT DIP OF ROCKS PRODUCES OPTICAL ILLUSION OF WATER FLOWING UP HILL, TO THOSE IN BOATS. THE WATER IS ABOUT 60 FEET DEEP AT LOW STAGE, ACCOUNTING FOR LACK OF CURRENT.

amination of the surface above the Chasm shows that slight depressions concentrate rainwater at these points, and so we see that the recesses result merely from ordinary processes, that the local intensification is merely that which happens everywhere.

One of the most interesting features of the Chasm is the Devils Oven, a cave high above ordinary water level, excavated by the surge of flood waters. Here the river makes a sharp bend to the left which the flood waters have difficulty of turning. Even at that no such deep reentrant and cave would have been cut, were it not for the fact that the fault, along which the river had been flowing from the right turn below Horseshoe Falls, weakened the rock at this spot. Movement along the Devils Oven fault crushed the rock in a zone nearly forty feet wide, and next to the chief plane of movement ground



ENTERING "THE POOL" AT THE END OF THE BOAT RIDE THROUGH AUSABLE CHASM

the sandstone to powder. Ground water seeping into the rock along the fault further softened and rotted the ground-up material until it has become clay. And so the river finds an ideal spot to gouge out a cave.

No doubt some visitors wonder why the river did not continue to follow the fault in a northeasterly direction to the edge of the Potsdam sandstone block, and there fall into the lake. This question emphasizes the method of cutting the canyon, for we must not forget that this took place by falls and rapids moving upstream in an already established channel.

Across the river from the Devils Oven is another interesting feature, a large block of rock that has slid down and moved away from the walls for several feet. Examination of the block, to which one end of the foot-bridge is attached and over which the trail runs, shows that an oblique joint permitted this block to settle down into a space undercut by the river. Ferns which have found a foothold in the crevices cut along the bedding planes add greatly to the beauty of this portion of the chasm.

A short distance below the Devils Oven the visitor comes to another interesting feature, several times repeated in the Chasm. Near the water level is the Punch Bowl, a portion of a round, well-shaped hole, the outer side removed by the river. A hundred feet or so farther along the trail, which here follows a ledge high above the river, Jacobs Well is another such hole, high and dry, far above the present river level. Both of these, and others elsewhere, are the geologic feature called potholes. These holes are bored into the stream bottom by stones whirled about in an eddy.

The Long Gallery owes its long straight course and high vertical walls to the presence of master joints. Great beauty is added by Jacobs Ladder, Mystic Gorge,

Hydes Cave, the Cathedral and Column Rocks, names applied to conspicuous reentrants or the columns remaining between them.

At the "Postoffice" visitors often wonder about the softness of the rock which permits them to pin cards and notes to it. Also the numerous small cavities attract attention. The latter are due to the presence of mud flakes in the original sediments that the weather finds easier to remove than the sandstone. On the other hand, the softness of the "Postoffice" layer, in a recess beneath a heavy overhanging ledge, is due to the unusually large calcareous content in the cement, which leaches out, leaving a soft sand. The "Postoffice" layer attracts the attention of geologists for another reason. They find fossils in it. Whether the fossils are there because lime deposits made the ancient sea bottom a favorable place to live, or whether the limy cement resulted from the presence of animals is a question one might debate at length.

From the Cathedral to the Pool the river flows along a nearly straight line, and fewer breaks occur in the walls. But about midway along this stretch a pronounced interruption occurs on the eastern side of the stream. Large slabs, dislodged from the walls are piled here to form Table Rock from which the boat leaves for the trip through the remainder of the Chasm. Here a thin trickle of water flows into the canyon from springs some distance above the river, and the constant wetting has rotted the sandstone, producing broken slopes. Besides this several sharp slots extend into the walls of this embayment. Contrary to most occurrences they are parallel and not at right angles to the stream. Advantage is taken of one to build a stairway, whereby the visitor may ascend to the top. If he does, he will be surprised to find in the forest nearby a dry canyon



TILTED STRATA IN UPPER BLOCK
AT KEESVILLE. THE CHASM HAS NOT BEEN CUT
THAT FAR UP STREAM.

about forty feet deep, which parallels the Chasm. A little investigation shows that at one stage the Ausable River had at least two parallel channels. No doubt, joints favored one more than the other, so that its channel became the deeper, and thus drew the larger quantity of water, thereby becoming the present channel.

The first part of the boat trip is through the Grand Flume, a narrow reach of the Chasm in which the water flows silently and deep. At some places the width is hardly a boat-length, but the river has a depth of many feet. The Flume's high smooth walls are due to evenly spaced master joints. An inter-

esting optical illusion in the Flume always interests the visitor. Here the water is quiet and, of course, level, but the rocks dip slightly, giving the optical effect of a sloping water surface. This is particularly noticeable if one looks back upstream from a boat.

Below the Pool the boat traverses rapids, an erosion level that has not formed a falls, due to somewhat irregular bedding. At the Whirlpool Basin the stream encounters the Whirlpool fault and the stream turns into a northeasterly course and follows it. The final erosion level is the rapids of that stretch. This fault parallels the Devils Oven fault, and the off-set strata may be seen at its lower end. Advantage is taken of the broken ledges near the fault for the boat landing from which the visitor climbs to the top of the Chasm walls, over a series of natural steps.

A short distance below this point the stream leaves the sheet of Potsdam sandstone and flows through glacial drift to the delta on the shores of Lake Champlain. Due to the unconsolidated nature of the drift, the valley has a normal V-shape below this point.

Ausable Chasm satisfies the aesthetic sense of the visitor. In providing this beauty spot for man's enjoyment, nature merely used the quiet, orderly, everyday processes at its command. No spectacular catastrophic method was employed. Beautiful Ausable River systematically and patiently removes the sandstone block by block, and then flowering plants, trees and ferns assist the weather in beautifying the walls.

THE EPIC OF YELLOW FEVER¹

By Dr. T. D. A. COCKERELL

EMERITUS PROFESSOR OF ZOOLOGY, UNIVERSITY OF COLORADO

IGNORANCE begets fear, and fear has a numerous progeny of cruelty, crime and despair. Human progress, during the past century, has been marked by the conquest of fear, resulting from increasing knowledge of nature, and of the ways in which it is possible to control or combat the evils which beset us. It is an extraordinary thing, that the work of a few hundred men, within the lifetime of the present writer, has saved the lives of millions of people, and by providing the possibilities of life has made possible the existence of other millions. While doing this, it has raised the standard of living, and reduced the incidence of disease, so that life, at least in respect to these matters, has been better worth living than ever before. Of the dread trio, war, pestilence and famine, the second and third are rapidly retreating, only the first remaining unconquered. When we understand the human mind as the scientific worker understands disease, perhaps we may conquer its pathological manifestations, and attain sanity, physical health and prosperity, and with these the happiness we all desire.

It is one thing to attain knowledge, and another to diffuse it among the people. Even scientific men are often slow to see the new light, and in spite of all our schools, the public has little understanding of scientific progress. It is therefore of the utmost importance to realize the unique qualities of our age, and show them in their historical setting, a drama of extraordinary interest to every intelligent person, if presented so that it can be understood. In such ways

¹ Robin Lampson, "Death Loses a Pair of Wings. The Epic of Gorgas in the Conquest of Yellow Fever." New York: Charles Scribner's Sons. 1939. 518 pp.

we may dispose the people to accept and adopt the good gifts of science, and by their support make other gifts possible in the future.

Robin Lampson, of the University of California, had written a book on the gold-rush of the forty-niners, in which he described the tragic events of the journey across the Isthmus of Panama. Lampson's mother, then one year old, so crossed the Isthmus in the arms of her mother, who rode a mule. This story called Lampson's attention to the awful menace of yellow fever, as it existed in those days, and led to the writing of another book, just published, having this disease as its central theme. On the title page this is described as "A Novel in Cadence," but such a description is perhaps rather misleading. The book does indeed deal with the life of William Gorgas, as it might be treated in a novel, if he had never existed; but as matter of fact it is a biography, minutely accurate in its details, based on years of careful work, with the cooperation of numerous persons who knew Gorgas and were present when many of the events related occurred. I presume that no one will ever again go to all this trouble, and a little later it will be impossible to get the assistance of contemporaries as Lampson got it. There is a brief introduction "Concerning Debts and Sources," in which the principal contributors of information are cited, and the more important books read are listed; it appears that Lampson consulted no less than 2,700 issues of daily newspapers to get the local color of the times. As regards the Cadence, the book is really written in a kind of prose, broken up into lines, a sentence frequently broken in the middle by this arrangement. However,

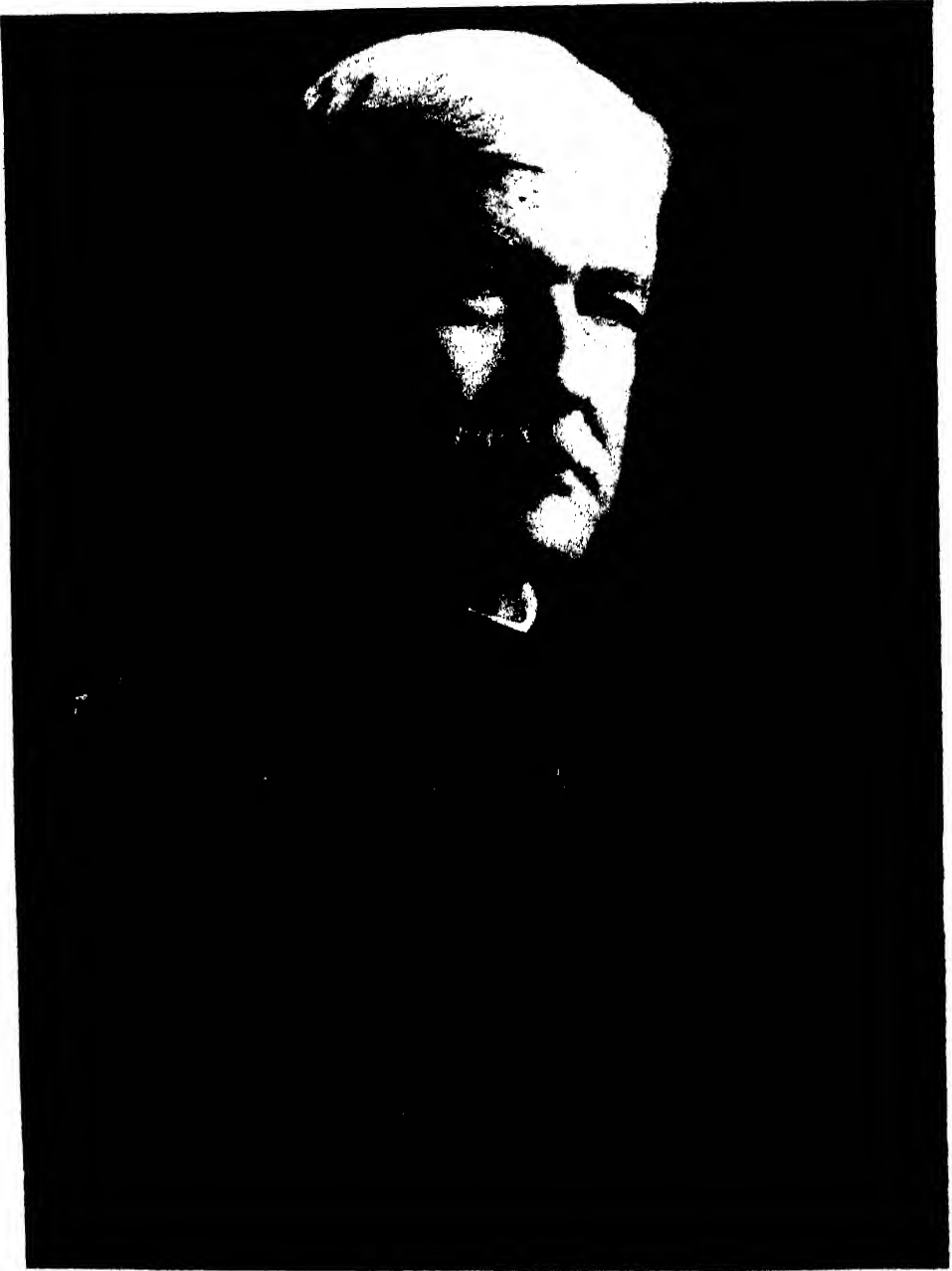

DR. WILLIAM C. GORGAS

**GREAT ADMINISTRATIVE OFFICER WHO TRANSLATED SCIENTIFIC FINDINGS INTO PRACTICAL RESULTS,
IN CONNECTION WITH YELLOW FEVER. DR. GORGAS DIED ON JULY 8, 1920.**

Lampson is a poet, and it must be admitted that he has given the book a poetic quality, which lends a charm, and also gives him a license to deal with all sorts of little matters which would seem rather out of place in an ordinary prose biography. It is natural to ask, why does the book deal with the life of Gorgas, who was not the man who finally resolved the puzzle of yellow fever? Why not Finlay, or Reed, Carroll, Lazear and Agramonte? The answer is obvious; the story of Gorgas is, or includes, the story of yellow fever; and if Gorgas did not discover the mode of transmission, he was at any rate the great administrative officer who translated the scientific findings into practical results, and thus had a brilliant and ever memorable part in the whole achievement. Born in Alabama, Gorgas was a son of the South; his father was a soldier in the Confederate army. William Gorgas grew up with an intense ambition to join the army, and his disappointment was tragic when he was refused admittance to the Military Academy at West Point. He then took up the study of law, but it was extremely distasteful to him. It seemed for a time that he had no particular mission in life, when Dr. Bartholomew, an old friend of the family, suggested that it might be possible to enter the army as a doctor. William eagerly snatched at this solution, although he had at that time no particular scientific training or interests. Thus we find him entering Bellevue Hospital Medical College (New York) as a student. The introductory lecture, by old Dr. Austin Flint, is set forth in some detail. I quote a small part, first describing the impression made by Flint, and then giving his concluding words.

And when the substantial tall figure stepped into
the room and assumed the dais,
No introduction and no praise were needed. The
keen, intelligent eyes
Were already smiling; the magnificent head
with its sparse gray hair, and the benignly



Courtesy of the Army Medical Museum.
DR. CARLOS J. FINLAY

WHO FOUND THE STEGOMYIA MOSQUITO WAS THE
ONLY MEANS OF TRANSMITTING YELLOW FEVER.



Courtesy of Science Service.
DR. WILLIAM H. WELCH

OUTSTANDING IN THE STUDY OF YELLOW FEVER.

Beautiful face with lush silvery sideburns, announced the man and his importance
Before ever the restrained, kind mouth began speaking. Even his stand-up collar

Was eloquent

(Said Flint) "You who today are entering here are earnestly and solemnly welcomed

To join that tradition—not as sailors signing up for a voyage, and not as apprentices

Rendering eyeservice, but as bridegrooms in a permanent marriage to medical science.

I only ask you to remember that Bellevue, built by the hearts and brains

Of many great men, is greater than any individual, greater than any

Or all of us here today—and I bid you to conjoin yourselves to her greatness,

Adding the stature of your personalities to these living buildings, enriching and enabling

Your lives by Bellevue's gifts and traditions."

From such a happy beginning, William Gorgas prospered as a medical student, only hampered by his poverty. In due course of time a new laboratory was opened at Bellevue, and William, now twenty-four years old, made the acquaintance of Dr. Welch, the founder of the first bacteriological laboratory in America. Through all the subsequent years, Welch was to Gorgas much as Manson was to Ross, constantly giving encouragement and information, and always a keen sense of the progress of science in relation to medicine. I have known other men of this type, who, doing very important work themselves, have

found time to correspond with and inspire those who, far from libraries and museums, might feel helpless and discouraged without this assistance. In this sense, then, Welch had a good part in the achievements of Gorgas. There is a most graphic account of the epidemic of yellow fever in Memphis, the utter terror and distress of the people.

And now, for a week, the dispatches had been a great chorus intoning, "Thousands, More thousands falling sick; hundreds, more hundreds helplessly dying!" Pestilence And death were the theme of the song; its refrain: "More doctors and nurses are needed, More doctors and nurses are needed!"

Gorgas, though not yet graduated, could not resist the appeal, and with a few others, started for Memphis. He was turned back because non-immune, after hearing that his best friend, who had graduated and gone to Memphis, had died of yellow fever. Atwater's last words, as he died, were: "I have studied yellow fever all my life. I have learned everything that is known of the plague. And I die knowing nothing about it—nothing—nothing."

So Gorgas entered the army as a physician, and was stationed at various points in the South.

Welch wrote:

Bellevue appreciates my labors,
They have gone to considerable expense in adding an adjoining room to the laboratory.
I feel like a potentate with three rooms where
I rule supreme with millions of microbes,
Billions of bacteria, as my subjects. We have
a new microscope, too, and a splendid
Supply of beakers and test tubes, a Bunsen-type
burner at each table—and three cages
Of white mice and guinea pigs and rats. . . .

This has been a momentous year: in Germany, Eberth has isolated the bacillus of typhoid; in France, Pasteur has immunized
Against chicken-cholera with cultures of attenuated virus; in America, Sternberg
Has discovered the eoccus of pneumonia; an Englishman in China, Doctor Manson, has demonstrated

That mosquitoes—of all things!—are the intermediate host of elephantiasis; and a Frenchman in Algeria,

Laveran, has discovered the germs of malaria in the blood. What a decade has just ended,



What an epoch is beginning! The malignant millenniums, the ignorant centuries, are surrendering

Their dependence on guesswork and magic; and medicine must now change from sorcery to a science.

Gorgas got yellow fever himself, and after a desperate time, recovered. His first thought was:

"How wonderful it is that now, for the balance of my life, I'm immune. Immune! I'll be clothed in steel. Yellow fever can't touch me—can't slam any more doors in my face." He rested for a moment. "Now they can send me right into the fire, wherever It's raging. I can study the disease without fear. I can open my eyes in the flames, And read what they say—if it's readable."

Eventually we come to the days in Cuba, where Gorgas was first assigned to duty on the hospital ship *Relief*, and later became the ranking sanitary officer of Havana. There is a vivid description of the inadequacy of the preparations for taking care of the American wounded, and the part played by Theodore Roosevelt, whose protest, contrary to strict army discipline, led to the return of the greater part of the army of occupation to the United States, and the consequent saving of very many lives. The American doctors classified yellow fever as a "filth" disease, and thought it could be eliminated by a general clean-up.

Dr. Carlos Finlay comes into the picture. Long before, he had become convinced that the *Stegomyia* mosquito was the means—the only means—of transmitting yellow fever.

"I believe that if we get Havana clean enough,"—Gorgas was now speaking fervently—
"We can free it of yellow fever."

All Finlay's native humor immediately submerged whenever yellow fever and filth were mentioned together.

"Th-th-that's where you are wrong, Doctor Gorgas,"
He said eagerly—but patiently, like a father setting right a misinformed son. "Here—



Drawing by Mrs. Bailey Willis

And here only—is the cause of yellow fever..."

He reached into his vest and pulled out a test tube.

"Here is the culprit. And a clean little villain she is."

He handed the glass tube to Gorgas, who looked at it closely and remarked, to cover his embarrassment, "Why, just a—
Mosquito."

"Just the agent of transmission in yellow fever," Finlay corrected him gently.

"A black-and-white beauty, with a lyre tattooed on her back—and extremely fastidious Habits. You may clean up the last milligram of filth in all Cuba—and still you won't touch her—
Or yellow fever."

The general impression was that Finlay was a very nice old man, and an excellent doctor, but unfortunately daft on the subject of mosquitoes.

From here the story moves swiftly to the point where Gorgas and Wood de-



Courtesy of Science Service.

DR. JESSE WILLIAM LAZEAR

ACTING ASSISTANT SURGEON IN THE UNITED STATES ARMY AND ONE OF THE YELLOW FEVER COMMISSION. HE DIED OF YELLOW FEVER CONTRACTED IN THE LINE OF DUTY WHILE SEEKING THE METHOD OF TRANSMISSION OF THE DISEASE.

cided that something more must be done, and Surgeon General Sternberg was urged to appoint a scientific commission to study yellow fever on the spot. This was done, and in spite of a strong bias against Finlay's views, the commission was gradually forced by the logic of events to turn to the mosquito, and plan experiments to prove or disprove its significance as the transmitter of the germ. The nature of these experiments, and their results, are well known; but while Lampson is here repeating an often told tale, he makes it extremely vivid and dramatic, so that the reader finds himself illustrating the book with pictures which readily form in his mind. The house full of bedding from fatal cases, in which men were confined for a long time, and yet remained perfectly healthy. The soldiers who volunteered to be bitten by infected mosquitoes, and did come down

with the fever, but fortunately recovered. The yellow fever developed by Carroll and Lazear, two members of the commission, and the tragic death of Lazear. Through all these tests the undoubted truth emerged, that Finlay was perfectly right, though it had not been in his power to prove his case as it had now been proved. The practical results quickly followed. Yellow fever was exterminated in Havana, it was eliminated from Panama, permitting the construction of the canal, and it is now a rare disease in any part of the world. Recently, it has been shown that in Brazil three other species of mosquitoes can be agents in the transmission of the fever, an unexpected complication which can be dealt with because understood.

A charming account is given of the banquet in honor of Finlay, who in reply to all the complimentary speeches says:

"Gentlemen, friends,
You are listening to a blissfully happy old man.
When the battleship *Maine* was blown up,
I was ready to retire as a doctor. I felt I had completed my professional life:
To appropriate the words of the beloved Stevenson, whose national blood I share,
I had served a full lifetime 'bringing air and cheer into the sickroom, and often enough,
Though not so often as I wished, bringing healing.' And I had discovered, I knew,
An indubitable ruby of truth. The savant-jewelers of the world would give me
Neither credence nor audience. But no matter—
I was not a young man any more; and from
Time,
My elder brother, I had learned to be patient with eventual things. Since I knew
That my truth was immortal, secure with the centuries, I could smile at the niggardly, negligent
Decades. Neither the contempt of my contemporaries nor my death could destroy this true stone.
Now, suddenly, as I enter the twilight of retirement and the mellow rich evening of age,
Time ticks me the high noon of my triumph and pours me the sweet wine of immediate justification—
Thanks to the selfless labors of these brave and intelligent men. And, friends,
Nothing is sweeter to age than to be honored by one's fellowmen."

SCIENTIFIC PIONEERING IN THE MIDDLE WEST

By Dr. C. JUDSON HERRICK

PROFESSOR EMERITUS OF NEUROLOGY, THE UNIVERSITY OF CHICAGO

I

THE last quarter of the nineteenth century was a critical period in the history of science and especially of the biological sciences in middle North America. Here I was born, and my childhood was spent at that time on the very frontier of natural science in this continent. The thrills of exploration were daily experiences.

How close that era is to our present day is vividly illustrated by tales told to me by the late Professor John Merle Coulter toward the end of his life. As a stripling he was one of the youngest members of the Hayden Expedition of the U. S. Geological Survey when they penetrated the unknown Yellowstone region and saw with incredulous eyes the splendors of Old Faithful and the other marvels of the geyser basins. Unbelievable rumors had filtered out with the fur trappers, but the first credible accounts were brought by the Hayden party, as I learned from the lips of one of its members.

That quarter-century saw a revolution in the biological sciences whose radical character can perhaps hardly be appreciated by the present younger generation. The prime objectives and essential methods which now we take for granted were scarcely imagined seventy-five years ago. The infiltration of Darwinian conceptions of evolution had begun and the transition from the descriptive methods of field natural history and museum work to the refinements of laboratory technique and experimental research was abrupt and disturbing. In the physical and earth sciences the situation was different, for "natural philosophy," the parent of physics and chemistry, was

experimental from the start and geology also came of age by slower growth. In biology the tumultuous revolution was consummated during a few decades of the lives of men still with us.

While growing up in Minneapolis during this critical period, some chapters of dramatic history were unfolding before my childish eyes under conditions which were especially favorable for its observation, as now reviewed in retrospect. My brother Clarence, ten years my senior, was a born naturalist and some of his adventures in scientific pioneering seem worthy of record if we can fit them into their natural setting of time and place. This we shall try to do, taking as our theme the annals of the Young Naturalists' Society which he, Thomas S. Roberts, Robert S. Williams and a few other sixteen-year-old boys organized in 1875. It is necessary first to survey the germination and growth of natural science in Minnesota and to picture the actual stage of development reached in that year.

II

When I was a child of nearly seven years my brother Clarence had finished his first year at the Minneapolis high school. We lived on a little farm beyond the southern outskirts of town, and I have vivid memory of a September day in 1875 when I rode in the family carry-all with my father and Clarence through the city and across the river the four miles to the university. While Clarence and his father conferred in the president's office about matriculation as a sub-freshman I remained outside. Some kindly body took me up the long stair-

ways to the cupola at the top of the big stone building, then new, which housed the university.

From that terrifying height we looked down almost directly into the gorge of the great River, for the campus at this point drops away in a sheer cliff of Trenton limestone, whose wealth of fossils intrigued the Young Naturalists, as they do their successors to this day. Up-stream the gorge terminates within a mile at the Falls of St. Anthony, and here spread out before our eyes was the great Government Work in process of construction. A dike of masonry 2,000 feet long supported an "apron" to protect the Falls from erosion. This expenditure of nearly a million dollars saved the Falls from imminent destruction and so saved the life of the city of Minneapolis.

During the leisurely descent from the cupola we peeked into classrooms, laboratories and the museum, filled with marvels and childish questionings. At the main entrance we rejoined the others and President Folwell put his hand upon my head and remarked with a friendly smile, "I see, my boy, that you have already been through the university, ahead of your brother."

The Mississippi River carved the destiny of the Middle West, and St. Anthony Falls made the city of Minneapolis. St. Paul, the state capital, was naturally first settled at the head of navigation in the river. Northward was unbroken wilderness whose settlement on the west side of the river was retarded by the government reservation at Ft. Snelling (established in 1819) and by treaties with the Indians. Franklin Steele located a claim on the east side of the Falls about 1837 and in 1849 the first plat of the town of St. Anthony was made, in the same year that the Territory of Minnesota was organized. The west side of the river above Ft. Snelling was ceded by the Sioux Indians to the government in 1851 and settlers began to

move in, but not until 1855 were squatters' titles to land west of the Falls confirmed. In 1854 there were not more than 12 dwellings on the site of Minneapolis, though a school was opened in 1852 and in the following year there were also a church, a Masonic Lodge, an agricultural society and several mills.¹

In 1875 the city of Minneapolis was still a frontier town. Only 25 years had elapsed since the first frame house was built west of the Falls and only 20 years since a plat of the settlement there was recorded. In 1872 the towns to the east and west of the Falls were consolidated as the city of Minneapolis, with a population of 18,316 people. The census of 1875 reported a population of 48,725 in Hennepin County, of which Minneapolis is the county seat.

During these two booming decades of expansion, frenzied speculation, panic and recovery, cultural development was not neglected. Schools came in with the first settlers. As early as 1857 there were eight organized churches. Lyceum lectures were provided and the Athenaeum laid the foundations of a great public library. In 1875 bulletins were published by the Minnesota Academy of Natural Sciences and the State Horticultural Society. After eighteen years of abortive blundering, the state university was firmly established on the east side of the Falls and a freshman class was matriculated in 1869, the first bachelors' diplomas being awarded in 1873.

Between 1860 and 1866 several reports on the mineral resources of Minnesota were published, and shortly after the opening of the state university the Geological and Natural History Survey of Minnesota was inaugurated under the direction of Professor N. H. Winchell. His first annual report to the Regents was for the year 1872. In 1875, accord-

¹ William Watts Folwell, "A History of Minnesota." Published by the Minnesota Historical Society, St. Paul. 4 vols. 1921-1930.

ingly, the survey had been in operation for only about four years, and exploration of the natural history of the state was only well started. In many fields of scientific interest the frontier began literally at the walls of the university building.

There was a nucleus of the State Museum of Natural History in the university even before the organization of the state survey. The first official recognition of the museum is in the annual report of the director of the survey for the year 1875. Its subsequent history has been systematically written and well illustrated by the present director, Dr. Roberts (my brother's boyhood chum), in commemoration of its removal in 1939 to a commodious and beautifully appointed new building.² From the humble beginnings of the 1870's the growth of scientific activity in this area has been rapid and fruitful, as graphically displayed in a statistical analysis of present conditions recently made by H. E. Zabel.³

This was the cultural environment of our community at the northwestern scientific frontier when in 1875 my six-year-old eyes were first opened to the natural world as an object of scientific interest. This scientific light dawned very gradually under the influence of my older brother, whose childish curiosity and sporting impulses were at that time suddenly canalized into a passion for science which was the dominant motivation of his subsequent life, and of mine also, though in my case maturing much later.

One of my early memories is of a letter received by the family from Clarence while he was away on a camping and collecting expedition with Tom Roberts

² Thomas S. Roberts, "Annals of the Museum of Natural History," University of Minnesota, Minneapolis, 1939.

³ H. E. Zabel, "Minnesota's Contribution to American Men of Science." Issued by Clay-Adams Company, 44 East 23rd St., New York, 1939.

and one or two other schoolmates. The boys were driving through the woods in a wagon and the letter included a graphic pencil sketch of a mighty tree riven by jagged forks of lightning and falling shattered across the road a few feet in front of the horse's head. As I now review the sketch in retrospect, the time schedule seems a little out of gear, for the bolt of lightning and the fallen trunk could not have been registered on his retina at the same instant; but the anachronism was not apparent to my childish mind and doubtless the thrilling incident played its part in quickening my interest in natural history. It was at about this time that Clarence and Tom dissected a whooping crane and discovered the long coils of the windpipe which provide the resonance chamber for the whoops. The observation was not new to science, but the boys did not know that and their enthusiasm about it infected the youngest as well as the older members of our family.

These boys before they were of high-school age ranged the forested hills, the swamps, the open prairies and especially the cliffs of the gorges below St. Anthony and Minnehaha Falls, all within a day's walk. These and the chains of little lakes which now embellish the city's enchanting parkways were then about as nature made them, unblemished by the hand of man. And all this was virgin soil for the naturalist.

III

Ellsworth Huntington has long been telling us of the influence of natural physical surroundings upon the patterns of growth of human cultures. What is true in the large is doubtless operative in the development of the individual man. Perhaps the Falls of St. Anthony and the other topographic features carved out of rock by the Father of Waters were equally significant agencies in shaping the growth of those alert boys

who matured within earshot of their roar and whose minds were naturally attuned to sympathetic response.

But there were other and probably more significant influences—trends of social reorganization and changes in the flow of the currents of intellectual movements of the time—which played obscure but doubtless very important parts in the stimulation and direction of interest in the case of these boys.

The cultural development of this community followed the best traditions of the colonial period. It has been pointed out that by 1850 our country exhibited four regions, each with its own characteristic social, economic and political pattern—the Northeast, the South, the Far West and the Middle West. Of the latter region James Truslow Adams says:

The old Americanism was to be found in the Middle West, which was yet preponderantly the land of the small town, the small farmer, and the pioneer—"folks." To be sure, the lengthening shadows of eastern North and South had crept over the Valley also, but in its upper portion, what we call the Middle West to-day, the old American dream lingered because it still had foundation in the economic and social life of the people.⁴

Further on in the same work Mr. Adams emphasizes the profound changes which followed the close of the frontier period at successive stages in our great western migrations.

[Here we witness the] forging out something new and uncommon from the common man, [something which] had come into being from the wedlock of the common man and the frontier, a marriage consummated over and over again in our history. The brood born from those who dreamed the dream grew and increased. But there would be nothing in the dream unless the new life of the common man could be made uncommon, unless out of the womb of democracy could come forth beauty of art and living that should fill the spirit with gladness and make the daily round of living something more than a perpetual subduing of the soul's wilderness for material purposes as we had subdued the wilderness of the continent.

⁴James Truslow Adams, "The Epic of America." New York. 1931.

The pioneer spirit of the upper Mississippi Valley was different from that of the Puritans and other colonists and it has played a vital part in shaping the American temper and form of government. Mr. Adams says, "For better or worse, the United States of to-day was cradled in the Mississippi Valley." The American dream of political liberty and personal freedom, with opportunity for each to enrich his life according to his own ability and interest here "could be prolonged until it became part of the very structure of the American mind."

Such were the families in which these boys grew up. The high school which they attended was probably not different from most of the others of the period in the Middle West. There was no teaching of science worthy of the name and there is no evidence that the rigid curriculum influenced them in any way in the stimulation of interest or guidance of their scientific activity. They came from good homes, but here again there was nothing in heredity or environment to serve as an activator of scientific interest. Their ancestors were plain people without academic training or traditions. They were, it is true, enterprising pioneers or they would not have settled where they did at the frontier; and to these boys, their offspring, the pioneer spirit was transmitted, though it took the quite original form of a passion for exploration of the natural world about them. The attitude of the parents, as Dr. Roberts tells me, was a "kindly tolerance and helpful assistance," but certainly this was not the source of their inspiration. Their interest in natural history was generated spontaneously; it was as natural for them as breathing.

IV

The Young Naturalists and their subsequent careers when examined in their native midwestern environment illustrate significant features of scientific history in this country. The revolution-

ary changes in scientific outlook and method which came with almost explosive violence a long generation ago swept these young men into the turbulent current of events of which they themselves were part. The three promoters of the society responded very differently to these influences; each of them made noteworthy contributions to this historic movement, and two of them, Roberts and Williams, are still with us.

During this transitional period the far-flung exploratory adventures of the field naturalists were supplemented and too often supplanted by intensive laboratory study of minute detail. This period also saw the inception of those experimental methods whose inflorescence and fruition have been the most characteristic features of the biology of the twentieth century. The Young Naturalists were sensitive to these changes in the spirit of the time, even though during the years of the life of their society field natural history of the old school was still the prevailing fashion. *The American Journal of Science and Arts*, founded in 1818 by Benjamin Silliman, and *The American Naturalist*, then in its ninth volume, were the chief national mediums of publication, aside from reports of the federal and state natural history surveys and proceedings of the older academies of science of the East.

The American Geological Society was founded in 1819, and out of this grew the American Association for the Advancement of Science, organized in 1848. These and other national organizations were active in all domains of scientific inquiry and especially in field surveys. Contemporary with these boys and in the prime of their scientific production were Louis Agassiz, Baird, Leidy, Asa Gray, Marsh, Cope, James Hall, Sir William Dawson, the two Winchells and many other pioneers at the frontiers of American science.

In the germination and growth of American science four sources are

easily recognizable.⁵ The early colonists brought with them the cultural patterns and mores of the countries from which they came, and among these British influence clearly predominated and our colleges were designed after English models. In the first decades of our republic French influence played a larger part, through such men as Franklin, Jefferson and finally Agassiz. During the second half of the nineteenth century German scholarship was pre-eminent and most ambitious American students completed their professional training in German universities. This influx of German trained scholars profoundly affected, not only our entire educational system, but the attitudes and interests of people in many other fields. These men initiated and controlled the organization of the graduate schools, thus transforming some of our colleges into universities which were conducted for the most part after the German pattern. The birth of true university ideals in this country may be dated approximately in 1876, with the opening of the Johns Hopkins University. Throughout the Middle West state-supported universities rapidly expanded, especially in the fields of science and industry. Contemporary with these three there was a fourth source of scientific culture—an indigenous development of naturalists on our own soil. These were the explorers, collectors and survey workers, many of whom were men with no academic training or connection.

During the organization of the universities, especially of the state universities, some of these field naturalists and survey workers were drawn into their faculties, where they served with great distinction, as their successors do to-day. Here they were given better facilities and a more stimulating environment.

⁵ C. A. Kofoid, *Proceedings of the 25th Anniversary Celebration of the Inauguration of Graduate Studies, University of Southern California Press, Los Angeles, 1936, pp. 230-235.*

In many academic circles the newer disciplines of refined laboratory precision and experimental procedures were inclined to disparage the "anecdotal" methods of the field workers. In fact, some of these laboratory men did not know or care to know the species upon which they were working or realize that lack of accurate knowledge of life-histories may vitiate the most exact experiments in physiology or genetics. The history of science in the Mississippi Valley from 1875 to 1900 presents many graphic illustrations of this abrupt transition in the methodology and objectives of biological research.

Fortunately the field naturalists held their own in this unequal contest, and to-day we are coming to see more clearly the mutual interdependence of laboratory work and field studies. The naturalist is not a bug-hunter or a pebble-picker. He is a student of nature. And whether nature be observed in the open or in the breeding pen, operating table and histological laboratory, the observer is still a naturalist—or should be. The popular distinction is based on method. As Yerkes has recently said:

Many scientists think of the naturalist as having been replaced by the experimentalist. I beg to offer contrary opinion and to maintain that the interests, objectives and methods of the two are supplementary, and neither substitutes nor alternates. For the naturalist, with minimal disturbance of organism or environment, attempts to find out about life as it is lived; while the experimentalist, with some definite problem in mind, seeks so to control the conditions of observation that solution shall be facilitated. . . . It would be ideal, as I see the situation, if in each of us biologists might be combined the interests and abilities characteristic of the best in field observer and laboratory worker.⁶

Yes, this is the ideal, and perhaps Dr. Yerkes himself approaches it as closely as any one now living.⁷ The Young

⁶ R. M. Yerkes, *American Naturalist*, 73: 97-112, 1939.

⁷ "Robert Mearns Yerkes, Psychobiologist." Pages 381 to 407 of "A History of Psychology in Autobiography," vol. 2, 1932, edited by Carl Murchison, Clark University Press.

Naturalists were just at the threshold of the momentous changes in biological practice to which reference has just been made. Field natural history was the vogue of their time and place, and yet we can recognize in the minutes of their society now before me prophetic gleams of the impending changes. Though these high-school boys could not grasp the meaning of the eddying currents of the physical, social and especially the psychological life of their community in 1875, they evidently were not unaffected by them.

V

These radical changes in the scope and methods of the biological sciences are now established on a firm basis, the newer refinements of laboratory technique and experimental control being closely articulated with enlarged and improved field observations. This consummation of the labors of the pioneer naturalists of the nineteenth century we now enjoy. But when search is made for applications of this true scientific method in the field of education, we are discouraged by the painfully slow progress achieved by blind fumbling. Advance has been retarded here, as in most other domains of social adjustment, primarily, I believe, because the effort has been handicapped in advance by the outworn tradition that values—the key factor in the problem—are beyond the reach of science. We still have some pioneering to do in this unsettled territory.

Exceptionally gifted children are not rare and they may appear in unexpected places. Unless these exceptional endowments find opportunity for growth and expression, each after its own kind, we are wasting the most precious of our natural resources. What are we doing about this?

The native endowments of the Young Naturalists were different from those of their schoolmates. There was nothing in

home or school to set them apart from the others. The school influence of 1875 tended the other way, toward regimentation with no recognition of individual differences in interest or capacity. The three promoters of the society were exceptional, not only in their passion for nature study, but even more so in their ability to educate themselves in the field of their choice. They had no guidance in this, and there was no repression.

This freedom from restraint is a vital matter, and I wonder if our schools today are doing much better than they did in 1875. Doubtless they are, but progress is hindered in curious ways that were not foreseen when the reform movements began. A generation ago the deplorably low standards of secondary education were raised by pressure from above, by forcing the high-school curriculum to conform with college entrance requirements. The desired result was promptly achieved, but at a cost of standardized mass-production in both the schools and the teachers' colleges admirably adapted to qualify the selected few to pass the standard college entrance requirements but ridiculously unfit for the five sixths of high-school pupils who do not go to college. In this connection Mr. Edison went so far as to say: "Formal education seems to paralyze curiosity. It makes the important subjects so dull as to give the youngster the notion that everything which is important has to be dull." Education has been my business for more than fifty years, and I think I know enough about it to plead guilty to Mr. Edison's indictment. This is too bad, but not so bad it can't be remedied.

In protest against this procrustean bed various "progressive" educational movements have run their riotous courses, sacrificing all serious mental discipline to the untrammelled license of free expression of the child's whimsies. Somewhere between these extremes there

lies a sound (but expensive) educational policy. The only reliable way to find out what this policy should be is to learn by carefully controlled experiment just what are the actual results of these various methods of adolescent education in fitting the pupils to meet the exigencies of life. Such investigations are in process, notably the "Eight Year Study" sponsored by the Progressive Education Association, whose report in five volumes appears in 1941.⁸ Many similar studies are now going forward and a factual basis is thus laid for urgent educational reforms.

The effective application of these empirical data in actual practice requires an understanding of the adolescent mind, whose achievement is an even more difficult enterprise. Here statistical methods fail us, for we are dealing, not with universals but with particulars. Education is a social program acting with and upon environment. Its machinery is external to the child. But learning is an individual matter with every pupil; nobody else can do it for him. The best that education can offer is stimulus and sympathetic guidance. No returns from our investments in improving educational environment can be hoped for beyond what capacity is inherent in the native endowments of the individual children. No two of these are alike and the most unpromising pupil may surprise us with remarkable achievement when the right approach to his latent capacity is discovered, and above all if the development of these capacities is not inhibited by stupid blundering. These latent capacities are sometimes hard to find; in other instances they express themselves unmistakably. An instructive incident in my own teaching experience may be recalled here.

At about the turn of the century a

⁸ Dorothy Dunbar Bromley, *Harpers Magazine*, No. 1090, pp. 407-416, March, 1941.

boy was growing up in an Ohio parsonage. He was a problem child, bright enough, with winning personality and excellent character, but failing in school. The greater part of a high-school course had been mastered, but he loathed it all. Passionately fond of out-of-doors, he would escape from the classroom at every opportunity and roam the fields—not idly but with eyes open and hands busy. He filled the house with stuffed birds, eggs, insects and all sorts of similar vermin. His mother, wiser than most, did not complain of the litter. But the parents were worried. It looked as if he never would finish high school, but was drifting toward the incompetence of a ne'er-do-well.

At this juncture a visiting clergyman sized up the situation, spent a few hours with the boy and his specimens and then said to him:

"Irving, do you know that at college they allow boys to study birds and out-door things and give credit for it the same as for book-work?"

"What! Do you mean that they would let me mount birds and bugs and show me how to learn their real names and give credit for it—the things I play hooky for now?"

"Yes, something like that."

"Then I am going to college."

"Good idea. But you know you will have to finish high school before they will let you in."

"That finishes me, I suppose. No! I'll do it."

And he did.

I knew nothing of all this when about a year later Irving registered in my freshman class in zoology. He impressed me as a shy, rather backward boy, and I feared he could not make the grade; but later when he began to bring in his

life-like mounted birds and other collections I slowly realized that here was that *rara avis*, a born naturalist. He had little interest or aptitude for the refinements of cytology, which were then in vogue in university circles; in language and mathematics he was a dud; but despite these handicaps he did become a great teacher in an eastern university, and the president of that institution asked me if I had another student of Irving's caliber to recommend to him. In our schools and colleges of to-day there is more urgent need of good teachers than of second-rate investigators.

The history of the Young Naturalists' Society is a record of an experiment performed for us unwittingly by a few sixteen-year-old boys who without encouragement or guidance beyond their own circle systematically organized their interests into an educational program which was internally motivated. The formal rules of procedure were conventional, but the design and actual operation of the educational machinery were their own. We have here an example of the way in which a small group of exceptional children educated themselves. They were not emancipated from discipline, but they learned to discipline themselves, each in his own way, and this is the ideal for which we strive in all education.

The records of this society reveal the germinative stages of three successful careers of research at the most critical formative period in their lives. The publication of a digest of these papers is contemplated, including copious extracts exactly as written in boyish emulation of the formal proceedings of great learned societies, spiced with juvenile enthusiasm and the crudities of school-boy diction.

HOW LIFE BECOMES COMPLEX

By Dr. S. J. HOLMES

PROFESSOR OF ZOOLOGY, UNIVERSITY OF CALIFORNIA

LEST the reader be led to expect a discussion of the distractions of living in our modern society, I may explain at the outset that this is a purely biological article. It deals with the complexities of the life processes in plants and, especially, in animals, and how these complexities came about.

Life presents an enormous range in complexity from that of the human body down to the bacteria or organisms even simpler, such as the filterable viruses, if they are organisms at all. An amoeba carries on the same fundamental life processes as a man, with almost no organs. It moves without muscles, transmits stimuli without nerves, digests without stomach or intestine, respire without lungs or gills, and reproduces its kind by pinching itself in two. An amoeba, which is by no means the simplest form of life, is the product of a long series of evolutionary changes. It occupies a niche in nature in which it has persisted with little change for millions of years, during which other animals have forged ahead and acquired structural organizations of great complexity and almost endless variety. If we compare the structure of a frog, an insect, a clam, a starfish or an earthworm, we find remarkable differences of form and internal organization, but the diverse organs of these animals are devoted to the discharge of the same essential functions. All of them have organs of digestion, absorption, respiration, excretion and reproduction. The varied structures of these animals represent so many different ways of solving essentially the same physiological problems. Why all this bewildering variety of structure and pattern?

Obviously, life as it has become more complex has followed many different paths. For the most part we can not say that one animal solves its problems better than another. The amoeba gets along very well in its way, and so does the starfish, the spider, the squid, the porpoise and all the rest of our animal relatives. They persist and perpetuate their kind, and possibly enjoy life after their fashion, and this is about all a living creature can reasonably expect. As Aristotle observed, the activities of all organisms center about two ends—the preservation of the individual and the perpetuation of its kind. These are the two great problems that face every living creature. Death to the individual or its kind is the penalty for failure to discover the correct solution. Organisms have tried different ways—millions of different ways—of finding an answer to these Sphinx riddles, and the number of right answers that have been hit upon is indicated by the multitudinous diverse types of plant and animal life. A higher type of organization would be of no advantage to a creature in certain situations. If an animal or plant occupies a niche to which it is well adapted, it may persist almost unchanged for an indefinite period of time. The lamp shell *Lingula* has changed very slightly since the Cambrian period. For animals that bury themselves in the sea beach, life some hundreds of millions of years ago was probably much the same as it is to-day. All along the course of organic evolution there are forms that have found their niche and have stayed there, while others that were more adventurous explored new fields and acquired profound

changes in adaptation to different kinds of environment.

There are some types of environment that favor an advance of organization, and life, which is ever ready to take advantage of opportunities for its own increase, has developed there into higher forms. Nature apparently strives to fill all kinds of situations with living inhabitants. What she seems to be interested in is having as many children as possible. Whether they are high or low in the scale is a quite secondary matter. Certainly, Nature has been remarkably successful in producing offspring of the most complicated structure along many different lines, and we may now consider some of the ways in which she has achieved this end.

One important influence is an indirect result of mere increase in size. Every student of elementary geometry has learned that as a body increases in size its surface increases as the square of its diameter, while its volume increases as the cube. When a body grows, therefore, its volume increases disproportionately to its surface. This fact has very important consequences for living organisms. In a spherical organism of 1, 2, 3 or 4 inches in diameter, for instance, the surface areas would be as 1, 4, 9 and 16, while the volumes would be as 1, 8, 27 and 64. But if the life processes went on at the same rate in these organisms, there would be a more rapid exchange through a given area of surface in the large organisms than in the small ones. As size increases, absorption of nutriment, the elimination of waste and exchange of gases in respiration will have to be carried on so much faster through a given area of surface that further growth would be automatically checked. Perfectly spherical organisms of homogeneous structure, therefore, could not attain a very large size; they never do. Where any considerable size is reached in a plant or animal, it is always attended

with structural devices for increasing surface in relation to volume.

A good deal of the complicated anatomy of higher animals is a result of extending surfaces devoted to the fundamental vital processes of absorption, excretion, digestion and respiration. Small animals can obtain sufficient free oxygen by absorbing it through the body wall. But where size increases, relatively more surface is required for respiratory exchange. Aquatic animals quite generally meet the situation by pushing out the integument to form gills. Among terrestrial animals gills, unless protected by structures by which they are kept moist, are usually replaced by organs that ramify within the body and thus keep respiratory surfaces protected from desiccation. Our lungs, for instance, are outgrowths of the anterior part of our digestive tube. The finer subdivisions of the bronchial tubes lead to very thin-walled air cells through which respiratory exchange readily occurs between the air and the blood in the capillaries with which the air cells are richly supplied. If our lungs were ironed out, so to speak, the total area of their surface in intimate association with the blood would be about equal to the wall space of a fair-sized room.

In organs devoted to absorbing food the same principle is abundantly illustrated. Consider the surface of a large tree with its numerous leaves having an expanse which may be more than an acre in area. In this expanse of leaves the carbon dioxide of the air is absorbed and, together with water, is built up into carbohydrates under the influence of sunlight. And in the root system with its millions of root hairs there is a great expanse of surface through which water and salts are absorbed from the soil. Organs of excretion, such as our kidneys with their numerous coiled tubules, are devices for bringing a large area of excretory cells into close relationship with

the blood. The same statement applies to glands of all sorts, whether devoted to the elaboration of digestive juices or the production of other substances. If we survey our own bodily structure or that of any other complex animal and consider how much of its make-up consists of extensions of surfaces involved in absorption, secretion, excretion and respiration, we will find that we have included no small part of its structural complexity.

But the story by no means ends here. In order to live at all every organism, even the simplest, must perform the basic functions of absorption, assimilation, respiration, excretion, conductivity and reproduction. But in order that these basic functions can be discharged in a more highly developed organism, other activities subservient to them have been superadded. Let me illustrate. All organisms must take in nutriment from the outside. In animals the food usually requires to be digested before it can be absorbed and gain access to the living protoplasm. The essential feature of digestion is splitting up food substances by means of enzymes, or ferments until they are rendered capable of solution and diffusion through living membranes. Digestion is a process subsidiary to absorption. The amoeba performs this function in little vacuoles in its protoplasm formed by the secretion of fluid around engulfed particles of food. These vacuoles disappear after their work is accomplished, and the undigested residue of the food is expelled to the outside. They are little stomachs improvised for the occasion. In a hydra we have permanent specialized organs set apart for the function of digestion, but the structures involved are of a very simple and primitive kind. In striking contrast with this is our own digestive machinery with its complicated stomach and intestine and the highly developed glands of liver and pancreas, to say nothing of numerous small glands elabo-

rating their specific kinds of digestive ferments. But where so much apparatus is devoted to digestion and absorption, still more apparatus is required in order that the parts can carry on their work. We have muscle fibers in the walls of the alimentary canal which in the oesophagus aid in swallowing, and in the stomach bring about the churning motions that facilitate the chemical part of the digestive process, while in the intestine they effect the discharge of food along its course. All these parts are equipped with blood vessels which supply oxygen, remove waste and carry away absorbed food materials to be distributed to other parts of the body. And, again, the movements of the muscular coats of the alimentary canal, the secretions of glands and the regulation of the blood supply are coordinated through the agency of the nervous system and also by special kinds of hormones or internal secretions. These agencies are required to make it possible for the parts more immediately concerned in digestion and absorption to function in an adequate manner.

But in addition to the organs that are directly accessory to the digestive apparatus, animals are equipped with tentacles, teeth and various other organs for the capture of prey. The sharp claws of the cat, the poison glands of the spider and the tentacles of the octopus are all devices to enable their possessor to capture prey upon which the digestive juices of these animals may act. But further complications arise by the development of organs and instincts subsidiary to these activities of capturing and overcoming prey. A striking instance is furnished by the common orb-weaving spiders. Toward evening in summer time one may often witness the marvelous performance of spinning an orb web. The making of the frame of the orb, the placing of the rays, the spinning of the spiral of sticky web and the formation

of the central disc, or hub, are carried out with a nicety and precision that have excited the admiration of all observers. The web finished, the spider takes up its position head downward in the center, with its feet on the rays where they readily feel the agitation conveyed by the struggles of an entangled insect. Following the signal, the spider rushes out upon its prey, often employing more web in the endeavor to impede the movements of its victim. Then comes the sudden rush, the burial of the fangs and afterward the leisurely meal. Here we have a complex series of acts in preparation for capturing prey, which in turn is a preparation to the acts of overcoming and feeding upon it, and these activities in turn are more directly subservient to the various acts involved in digesting and absorbing food.

We might take another illustration from the industry of the hive bees, among which there is not only food collecting, but food storing and, in preparation for food storing, the construction of the beautifully regular six-sided cells of the honeycomb. Or, again, we might cite the grain gathering and storing of the agricultural ants and the peculiar fungus-growing industry of certain species of ants and termites. These activities, indirectly accessory to nutrition, often involve the evolution of highly specialized organs for their performance. Among such are the pollen basket on the hind legs of the hive bee, the pollen combs, the wax glands on the underside of the abdomen, and the peculiar wax pincers by which the scales of wax are removed. The whole structure and instinctive behavior of the worker bee have been profoundly modified in relation to the accessory nutritive activities upon which she unselfishly spends so much of her energies. We thus see how, in relation to the primitive function of nutrition, one complication leads on to another, and this again to a third, and so

on. The basic vital process of (A) absorption becomes associated with the preliminary and preparatory activities of (B) digestion. These may finally involve elaborate mechanisms for their discharge, but subsidiary to these there are worked in (C) specialized modifications of the muscular and nervous systems, to say nothing of other parts. Subsidiary to the preceding functions we have (D) activities of collecting food, involving, often, complicated structures and modes of behavior, and subsidiary to these, again, we have (E) such acts as web spinning and comb making, and many others, each entailing more or less extensive changes of structure and behavior. In this way life becomes more and more complex.

We see much the same sort of thing exemplified in the development of industry. One may manufacture such articles as cigarettes with a very simple layout. A few girls with very simple apparatus could turn out a goodly number of these articles in a day. But if a primitive plant should grow into a large factory, we would find the installation of more complex machinery and no end of accessory activities. There would be janitors, bookkeepers, stenographers, business managers, traveling salesmen, special buyers, pay clerks, advertisers, night watchmen, and perhaps attorneys and plain clothes detectives, all of whom would be engaged in work subsidiary, directly or indirectly, to the fundamental function of the factory. Although the basic function of nutrition may be a more complicated process than making cigarettes, it comes to require in special cases a vast deal of machinery to carry out the subordinate activities and the activities subsidiary to these, and so on to the spinning of the spider's web and the building of the comb of the hive bee.

It would be instructive to consider another illustration of how complications pile up in the evolution of life, and this

time I will select the process of reproduction, which is certainly a basic vital function characteristic of all species of living organisms. Its simplest manifestation is in the fission of a very primitive form of life, such as a bacterium. The propagation of all but the simplest of the one-celled organisms commonly involves in some part of the life cycle the intervention of sex. So far as is known, the bacteria, the blue-green algae and some other groups are primarily sexless. Doubtless, life existed on the globe for many millions of years before sex entered upon the scene, but it is a significant fact that it never evolved very far. One might indulge in flights of fancy as to what plants and animals might be like if evolution had continued to go on without the development of sex. Certainly, the higher animals, if there were any, would be very different from what they now are structurally, physiologically, emotionally and intellectually. The reader may try to imagine what sort of creatures they would be. His guess would be as good as that of the professional biologist.

We shall not discuss the problem of the biological significance of sex further than to state that its great importance in evolution is attested by the fact that only very primitive organisms were evolved until the advent of sexual reproduction. Then evolution took a spurt upward. The most primitive manifestation of sexual reproduction is the conjugation of two similar simple organisms. Both the nuclei and the surrounding protoplasm of the conjugants fuse to become one flesh, after which, often following a resting stage, multiplication by fission goes on as before. At first there is no clear distinction of male and female, but in many one-celled organisms, plants as well as animals, the conjugating individuals are differentiated into a large, relatively immobile female cell and a much smaller, actively swimming male cell. This differentiation parallels the

differences between the ovum, or egg cell, and the spermatozoon of the higher animals.

In all the multicellular animals the sex cells are sharply differentiated into eggs and sperm, but in more primitive groups, such as sponges, corals, jelly fish and many worms and molluscs, sexual reproduction is usually accomplished quite simply by discharging the eggs and sperm into the water and leaving their union to chance. In all but the simplest of the multi-cellular animals the sex cells are produced in specialized organs, often provided with ducts for their transfer to the outside. But sexual reproduction does not involve elaborate behavior or many accessory structures until the development of internal fertilization. This step is one of tremendous importance for further evolution. We see it foreshadowed, as it were, in certain groups of animals in which the fertilization of eggs still occurs outside the body, by the development of instincts that bring about a close association of the sexes during the breeding season. During the period of egg laying in fishes, for instance, the female is closely followed by the male, who frequently rubs against her body and discharges his milt, or sperm, over the eggs as soon as they are extruded. In the breeding season the males of many species develop brighter colors and, sometimes, small bodily protuberances and other structures associated directly or indirectly with the function of mating. These modifications are not, as a rule, extensive. In frogs, toads and some other amphibians a closer association of the sexes is secured by the clasping instinct of the male. As in fishes, the discharge of the eggs from the female prompts the simultaneous discharge of the sperm from her male companion, the eggs being fertilized in the water by the sperm which penetrate their jelly-like covering. That such mating habits probably led to internal fertilization is indi-

cated by the fact that among both fishes and amphibians there are species in which the eggs are fertilized within the body of the female, as they are in all the higher classes of vertebrate animals. But, however fertilization of eggs within the body may have been originally accomplished, the process once started has entailed most elaborate developments; it has led to the evolution of diverse structures for the transfer of sperm cells, organs for clasping the female, and the perfection of organs of sight, smell and hearing which enable the males to discover the whereabouts of the other sex. The enormous eyes of the drone honeybee and the elaborately developed antennae which are the olfactory sense organs of male moths are among the many evidences of the influence of the function of mating upon the evolution of organs of sense. When internal fertilization is once evolved, the male is confronted with the problem of distinguishing the female of his own species from all other kinds of living creatures. Here is one of life's hurdles which must be surmounted if the species continues to exist. Consider, for instance, the nuptial flight of the queen bee. When the young queen makes her first flight into the air, a number of the big-eyed drones immediately start in pursuit. Their course is directed not only by sight but by odor, which they detect by their well-developed antennae, which are much more richly supplied with sense organs than those of the queen or worker. Mating takes place in the air and the process is usually fatal to the male. The sperms are stored in a special receptacle in which they may live for years. Apparently, the queen controls the outlet of this organ because eggs laid in drone cells are not fertilized and hence develop into drones, while those which are fertilized develop into queens or workers. In this case internal fertilization involves not only specialization of the reproductive apparatus of both sexes,

but the elaboration of organs in the male useful in distinguishing and following the female. The function of mating has, so to speak, put a premium upon the development of activity, acuity of sense, powers of discrimination and special aptitudes of various kinds. It has thus been a potent factor in the evolution of mind, as well as bodily organization. This is indicated especially by the frequently elaborate behavior of many animals preparatory to the act of fertilization. In birds especially, but also in certain insects and spiders, the male performs various antics while courting the female, as Darwin has described in much detail in his writings on sexual selection. Courtship is obviously an activity subsidiary to the union of the sexes and it has led to the development of many structural features and special instincts for display. The brilliant ornamentation of male birds, so wonderfully manifested in the peacock's tail and the plumage of the birds of paradise, is associated with instincts for the effective exhibition of these attractions. A large part of the courtship of male birds involves also the employment of song. Doubtless, few people have ever reflected that the voice owes its origin and at least the early stages of its evolution to its use as an aid to mating. The power of making sounds is possessed in greater or less degree by many kinds of insects, but where it is conspicuously manifested, as in crickets, katydids and cicadas, it is employed in courtship. In the vertebrates, although there are a few fishes that make noises of uncertain function, the voice proper first appears in amphibians. The breeding season in the spring is the time in which the croaking of male frogs is most vociferous, and it has been observed that the females go to the localities from which the croaking proceeds. In both the birds and the mammals the voice has acquired other than sexual functions, but it still retains

its primitive employment as a sex call, a function which has received perhaps its acme of perfection in the song of the nightingale. To a certain extent vocal sounds are made in connection with the battles of the males for the possession of the females, as is exemplified by the nocturnal encounters of tom cats and the challenge uttered by the bull moose as he goes on the war path against possible rivals. But in these cases also the use of the vocal apparatus is closely associated with the function of mating.

With the evolution of parental care the voice comes to be extended beyond its original sexual function and is employed in different ways in fostering and protecting the domestic group. The danger chirr of the mother quail sends her flock under cover; the cluck of the hen keeps her brood closer around her, and her peculiar call indicative of the discovery of food brings the young chicks to share the prize. And the cry of the young mammal causes the mother to rush to the defense of her offspring or to supply its nutrient wants. Crying, by the way, plays a very important biological function which human beings share with their humbler mammalian relatives. It is the part of human language which rests upon a basis of pure instinct. It is a call for help prompted by hunger, distress, fear or perhaps merely the desire for attention, as it may come to be in spoiled babies. On the other hand, the response of the mother to the cry of her infant is doubtless prompted by a strong instinctive impulse even in human beings, as it clearly is in lower mammals.

As social groups come to be evolved, the voice comes to be employed as a means of integrating the activities of the members. Warning cries, grunts of satisfaction in comradeship, cries of distress that bring others to the defense of an animal that is attacked and many other utterances which are instinctively made and instinctively responded to are

wide-spread among the higher social and gregarious animals. Finally, in man the voice comes to be employed in articulate speech with all that this implies for the further evolution and cultural development of mankind.

We have already commented on our inability to predict what kind of organic world would have been evolved had it not been for the advent of sex. Very probably its highest products would have been voiceless, and since organs of hearing tend to go along with organs for the production of sound, the creatures would have probably also been deaf.

I must point out also another line of development which has grown out of activity associated with, and subsidiary to, the function of reproduction. This is the evolution of parental care. Maternal affection does not enter upon the scene until comparatively late in the evolution of animal life. The whole vast groups of worms, molluscs, echinoderms and crustacea do not manifest the least solicitude for the welfare of their offspring. The same statement is true for the great majority of insects, spiders, fishes and amphibians. Among the lower invertebrate animals the discharge of the sex cells into the water fulfills all responsibility for the perpetuation of the species. In the higher invertebrates the simple physiological functions of producing and discharging sex cells are accompanied by accessory activities of various kinds. Many species of insects devote much care to laying eggs in situations that provide food for the future larvae. One might write a whole treatise on the varied and highly specialized modifications of egg laying. The cabbage butterfly is careful to deposit her eggs upon cabbages, mustard or some other member of the natural order of Cruciferae. The mother blowfly chooses meat, if tainted so much the better. The solitary wasp, according to its kind, hunts out a narrowly restricted group of beetles, grasshoppers or insect

larvae, stings her victim so as to paralyze but not to kill it, lays an egg upon it, buries it in a hole, carefully fills the hole with dirt, then leaves her progeny to its fate. No maternal affection here. In fact, the mothers do not recognize their offspring as any kin of theirs, if they see them. Normally, they never do see them. The whole elaborate and highly specialized performance is gone through blindly and instinctively. There are many kinds of insects which spend much effort in making receptacles for eggs and in storing food for their progeny. Numerous species of solitary bees provision their nests with pollen and honey which the larva feeds upon. Only in a few species do the mother bees remain with the nest and supply food directly to the larvae after they have hatched from the eggs. Care for eggs long antedates care for what comes out of the eggs. But when the association between the parents and their living offspring was once established, a line of evolution was started which has led to the most momentous consequences for the further development of animal life.

I shall pass over the manifestations of care for offspring as it has developed in ants, bees and termites among social insects, and its temporary appearance in a few groups of fishes in which the parents may accompany the young for a short time until the school becomes scattered. In birds one may find various stages from types in which the parents foster and protect the young for a short time and then leave them to shift for themselves, to the domestic behavior of the higher song birds which raise their broods in carefully constructed nests and spend much of their time in keeping the nests clean, brooding their offspring and finding food to fill their hungry mouths. The more care is expended on offspring the more helpless they become, and the more dependent they are upon the ministrations of their parents. Successive

generations become more closely tied together. In solitary wasps they are completely separated. Neither knows the other. In the robin they are intimately united for a prolonged period. One may often see a nearly full-grown robin soliciting and receiving food from its indulgent parents after it is perfectly able to forage for itself.

Among the mammals, the care of offspring has become part and parcel of the perpetuation of life. In fact, the possession of mammary glands, the unique structural feature to which the class of Mammalia owes its name, would be valueless in the absence of the maternal instinct to foster and nourish the young, and the correlated instinct of the young to obtain its food from the maternal fount. As in birds, parental care increases, as a rule, as we pass from lower to higher forms. In the apes it is exhibited in many ways that appear quite human. We may regard it as the source of social sympathy and affection. It is the earliest form of true altruism. Without it man would probably never have become a "moral animal," as he was said to be by Herbert Spencer.

Parental care, as I have attempted to show (although lack of space forbids producing sufficient evidence for this conclusion), is an outgrowth of accessory reproductive activities which have been superadded to the more primary reproductive functions. If it has afforded the evolutionary basis for altruistic behavior it is because reproduction is fundamentally and essentially an altruistic function. It is concerned not with the individual *per se* but with others. We can not say that altruism evolved out of egoism. Both are present in the simplest organism that divides by fission. Both are coeval with life itself.

In discussing the ways in which life comes to be more complex I have taken for purposes of illustration a few of the

basic functions of living. One might show how complexities heap up in relation to various other fundamental life processes. But evolution along any one of these lines has important interconnections with other lines, and it frequently happens that organs developed for one function become worked in to perform other functions as well. The web spinning of spiders, to which we have alluded, whatever its original use may have been, is employed not merely as accessory to food getting, but for making nests and retreats, for making cocoons for enclosing the eggs, for constructing the neatly-fitting door of the trapdoor spider, for so-called ballooning habits by which young spiders are carried for great distances by the wind and for a number of minor functions in different species of spiders.

Thus, a function evolved as accessory to another function, which may itself be accessory to a third, may branch out on its own account and lead to a great variety of developments.

During the long course of its evolution life has always been seeking for aid in trying out all sorts of new ways of doing in the endeavor to find any that may be helpful somehow in carrying on its more fundamental processes. The young girl I saw a few minutes ago who stopped to powder her nose and apply her lipstick with the aid of a small mirror was engaged in activities indirectly accessory to maintaining the stream of life. It is because we have taken on so many of these indirectly subservient activities that we have finally come to be so fearfully and wonderfully made.

NEUTRINOS VS. SUPERNOVAE

By Dr. G. GAMOW

PROFESSOR OF THEORETICAL PHYSICS, GEORGE WASHINGTON UNIVERSITY

STELLAR EVOLUTION

WHAT are the sources of energy radiated in such large amounts by different stars and, in particular, by our own sun? How long have these sources been in action, and how long can they still last? What changes, if any, can one expect in a star during its course of evolution? Those are the questions which have presented themselves to the human mind ever since the inception of scientific astronomy and which represent at present probably one of the most interesting and exciting problems of theoretical astrophysics.

All previous attempts to account for stellar radiation as due to some chemical reactions (burning) taking place in the stellar interior, or to consider it as the result of the steady contraction of the stellar body, fell short of their aim since

the amount of energy liberated in such processes was not enough by far to explain the long existence-period of the stellar universe.

Only the discovery of radioactivity and the recognition of the vast amounts of subatomic energy stored in the interior of tiny atomic nuclei opened the way for the understanding of stellar energy sources and stellar evolution. It was shown by Atkinson and Houtermans as early as 1929 that the extremely high temperatures (about 20,000,000° C) existing in the stellar interior must induce the processes of nuclear transformations similar to those which we obtain under laboratory conditions by bombarding various elements with very fast particles. Using the quantum theory of nuclear processes, they have been able to show that, under conditions existing in

the stellar interior, the protons, animated by a rapid thermal motion, will easily penetrate into various light nuclei causing their disintegration, and liberating amounts of subatomic energy sufficient to support stellar radiation over a period of many billion years.

But, although it was already clear at that time that the thermonuclear reaction responsible for the energy supply of stars must be taking place between hydrogen nuclei (protons) and the nuclei of some other light element, the insufficient knowledge of various nuclear processes prevented the discovery of the reaction itself. And it was only recently (1939) that the particular nuclear reaction, or rather chain of reactions, responsible for the energy production in the sun and all other stars of the main sequence was found by Bethe. According to Bethe, the light element which reacts with hydrogen (in the nuclear sense) at the high temperatures of the stellar interior is ordinary carbon. Penetrating into the interior of carbon nuclei, protons emit their surplus energy in the form of hard γ -rays, and remain in the bound state, thus giving rise to somewhat heavier nuclei. However, the nucleus of carbon can not hold more than four protons and, as soon as the saturation point is reached, it "spits them out" in the form of a single α -particle, or the nucleus of a helium atom. The carbon nucleus emerging from this process in its original form is ready again to capture new protons and to unite them into a new α -particle. Thus we see that the carbon plays only the role of what the chemists would call a catalizer, and the net result of nuclear reaction is the transformation of hydrogen into helium.

Estimating the total energy which must be liberated in this carbon-cycle at the temperatures existing in the interior of the sun, Sirius and other stars, Bethe was able to show that it coincided with the observed radiation of these stars.

Since the nuclear reactions, trans-

forming hydrogen into helium, cause definite changes in the physical properties of stellar matter, one should expect that they must result in certain changes of the observed characteristics of the star itself. This question was studied in some detail by the author of this article, and it was found that the steady decrease of the hydrogen content in the star must lead to a quite considerable increase of its luminosity. The radius of the star suffers but very little variation, so that the increasing luminosity must be connected with a progressive increase of the surface temperature. Thus, for example, in the case of our sun, the decrease of the hydrogen content from its present value of 35 per cent. down to 1 per cent. (this decrease requires about 10 billion years) will increase the luminosity by a factor of a hundred, and make the surface of the sun so hot that the astronomers of the future will classify it as a class A star. It is needless to say that these will be, in any case, not terrestrial astronomers since, due to the increase of solar light and heat, the surface of our planet will be by that time very hot indeed (about 300° C) and life on it will be quite impossible.

After the star, following the path of its evolution, reaches this state of maximum luminosity, the hydrogen content in its body will be entirely exhausted. In the absence of hydrogen, the energy liberation due to nuclear transformations drops down to zero, and, being deprived of its subatomic energy sources, the star is bound to start a slow contraction. During these late stages of stellar evolution, the radiation of the star is supported by the gravitational energy liberated in contraction, and the luminosity of the aging star is gradually dropping down. The final stage of the contraction must be represented by a very dense star which might be, however, still quite hot. Examples of such dying stars are given by the so-called "white dwarfs" possess-

ing very low luminosities, and the esti-

mated density exceeding the density of water by a factor of several hundred thousand. Afterward such a "white dwarf" star will finally cool down, its luminosity will drop down to zero, and we will have a dark stellar body of extremely high density. Such "black dwarfs" are probably rather numerous in the inter-stellar space, but escape astronomical observation because of the lack of sufficient radiation.

STELLAR CATASTROPHES

The process of stellar evolution, described in the previous section, is a slow, continuous process and all changes in the luminosity and geometrical dimensions of the star require many millions of years. Astronomical observations tell us, however, that very often stars undergo changes of a much more catastrophic character, the process being known as a nova explosion. Within a few days, a star, which did not seem before to differ much from any other star in the sky, increases its luminosity by a factor of several hundred thousand and its surface becomes evidently extremely hot. The study of the changes in the spectrum accompanying this sudden increase of luminosity indicates that the body of the star is rapidly swelling up, and that its outer layers are expanding with the velocity of about 2,000 kilometers per second. The increase of luminosity is, however, only temporary, and, after passing through the maximum, the star begins slowly to settle down. It takes usually about a year before the luminosity of the exploded star returns to its original value, though small variations of stellar radiation have been observed after considerably longer time intervals. Although the luminosity of the star becomes normal again, one can not say the same about its other properties. A part of the stellar atmosphere, participating in the rapid expansion during the explosion phase, continues its outward motion, and the star

is surrounded by a luminous gas shell of gradually increasing diameter. The evidence concerning permanent changes of the star proper is as yet very indecisive, as there is only one case in which the spectrum of the star was photographed before the explosion (Nova Aurigae 1918). But even this photograph is seemingly so imperfect that the conclusion concerning surface temperature and the radius of the pre-nova stage must be considered as very uncertain. However, it seems that the collapse process may be connected with the increase of surface temperature, which, in view of about equal luminosities of pre- and post-novae, would indicate a smaller radius.

Somewhat better evidence concerning the result of the explosion in the body of the star can be obtained from the observations of the so-called supernovae explosions. These vast stellar explosions, which happen in our stellar system only once in several centuries (in contrast to ordinary novae, which appear at the rate of about 40 per year) exceed the luminosity of ordinary novae by a factor of several thousand. During the maximum, the light emitted by such an exploding star is comparable with the light emission of the entire stellar system. The star observed by Tycho-Brahe in 1572 and visible in bright daylight, the star registered by Chinese astronomers in the year 1054, and probably the Star of Bethlehem represent typical examples of such supernovae within our stellar system, the Milky Way.

The first extragalactic supernova was observed in 1885 in the neighboring stellar system known as The Great Andromeda Nebula, its luminosity exceeding by a factor of one thousand the luminosities of all other novae ever seen in this system. In spite of the comparative rarity of these vast explosions, the study of their properties has made considerable progress in recent years due to observations of Baade and Zwicky, who were the first to recognize the great difference

between the two types of explosions and began the systematic study of supernovae appearing in various distant stellar systems.

In spite of the tremendous difference in luminosity, the phenomena of supernovae explosions show many similar features with the ordinary novae. The rapid rise of luminosity and its subsequent slow decrease in both cases are represented (apart from the scale) by practically identical curves. As in the case of ordinary novae, a supernova explosion gives rise to a rapidly expanding gas shell, which, however, takes a considerably larger fraction of the stellar mass. In fact, whereas the gas shells emitted by novae become thinner and thinner and dissolve themselves rapidly in the surrounding space, the gas masses emitted by supernovae form extensive luminous nebulae involving the place of explosion. It can be, for example, considered as definitely established that the so-called "Crab Nebula," seen at the place of the supernova of the year 1054, was formed by gases expelled during that explosion.

In the case of this particular supernova we also have some evidence concerning the star remaining after the explosion. In fact, in the very center of the Crab Nebula, observations show the presence of a faint star which, according to its observed properties, must be classified as a very dense white dwarf.

All this indicates that the physical processes of supernovae explosion must be very analogous to those of the ordinary novae, although everything is happening on a much larger scale.

THE CAUSE OF STELLAR COLLAPSE

Assuming the "collapse-theory" of novae and supernovae, we must first of all ask ourselves about the causes which could lead to such a rapid contraction of the entire stellar body. It is well established at present that the stars represent giant masses of hot gas, and that in the state of equilibrium the body of the star

is supported entirely by the high gas pressure of the hot material in its interior. As long as the various thermonuclear processes, described in the first section of this article, are going on in the center of the star, the energy radiated from the surface is being replenished by subatomic energy produced in the interior, and the state of the star changes but very little. As soon, however, as the hydrogen content is completely exhausted, no more subatomic energy is available and the star must begin to contract, thus turning into radiation its potential energy of gravity. The process of such gravitational contraction will, however, go very slowly, since, because of the high opacity of stellar material, the heat transport from the interior to the surface is very slow. It can be estimated, for example, that in order to contract to half of its present radius, our sun would require more than ten million years. Any attempt to contract faster than that would immediately result in the liberation of additional gravitational energy which would increase the temperature and gas pressure in the interior and slow down the contraction. It can be seen from the above considerations that the only way to accelerate the contraction of a star and to turn it into a rapid collapse as observed in the case of novae and supernovae, would be to devise some mechanism which would remove from the interior the energy liberated in contraction. If, for example, the opacity of stellar matter could be reduced by a factor of several billions, the contraction would be accelerated in the same proportion, and a contracting star would collapse within a few days. This possibility is, however, quite excluded, since the present theory of radiation definitely shows that the opacity of stellar matter is quite definitely a function of its density and temperature, and can hardly be reduced even by so much as a factor of ten or hundred. McCrea's hypothesis, according to which the excess energy is

escaping from the stellar interior in the form of cosmic rays, also fails in this case. In fact, although the penetrating power of cosmic rays is considerably higher than that of ordinary radiation, they still will be completely absorbed before they pass even a negligible fraction of the stellar radius.

It was recently proposed by the author of this article and his colleague, Dr. Schenberg, that the real cause of stellar collapses is due to certain tiny particles, which were but recently introduced in physics and are known under the name of neutrinos. The necessity for the introduction of this new kind of particles, which are entirely different from any other particles yet known to physics, resulted from the detailed study of the so-called β -decay of radioactive bodies in which the unstable nuclei of various elements disintegrate with the emission of free electrons (β -particles). A very peculiar property of the process of β -decay consists in the fact that, whereas different nuclei of the same radioactive element emit electrons with widely varying energy, there is no trace of any other radiation which would compensate for these differences. Very careful calorimetric measurements carried out by Ellis (in 1927) and repeated still more carefully by Meitner (in 1930) definitely established that there is a discrepancy in the energy balance of such transformations, and yet, using very thick lead-absorbers, one was unable to "catch" anything else than original electrons.

To this unexplainable loss of energy was added an analogous trouble with the angular momentum of decaying nuclei, and one was facing the possibility of either discarding the conservation laws of energy and momentum, or introducing some new kind of hypothetical particles which would carry them away in an "unobservable way."

It was first suggested by Pauli that these run-away particles, which he called "neutrinos," can account for all ob-

served discrepancies if one supposes that they carry no electric charge and possess a mass considerably smaller than the mass of the electron. During the last ten years, neutrinos gained a considerably important position in nuclear physics, in spite of the fact that all the attempts at their direct observation have inevitably failed. The difficulty of detecting these new particles through some direct effect can be, however, simply understood on the basis of theory, since it can be calculated that the neutral particles of such small mass would easily pass through many thousands of kilometers of lead without suffering any absorption! The character of neutrinos has been very ingeniously summarized by Dr. Swann, who said, "The neutrinos are like the world war debts. You never expect to see it paid, but you satisfy your conscience and the conscience of your debtor by keeping it on the records."

It is clear from the above description of the new particle that it is just the right agent to remove the surplus energy from the interior of a contracting star, since the entire body of the star is just as transparent for neutrinos as a window pane is for ordinary light. It remains to be seen whether the neutrinos will be produced, and produced in sufficiently large numbers in the hot interior of a contracting star, and the investigations of the author of this article and Dr. Schenberg show that this is just the case.

The reactions which must be necessarily accompanied by emission of neutrinos consist in the capture of fast-moving electrons by the nuclei of various elements. When a fast electron penetrates inside of the atomic nucleus, a high energy neutrino is immediately emitted, and the electron is retained, transforming the original nucleus into an unstable nucleus of the same atomic weight. Being unstable, this newly formed nucleus can exist only a definite period of time, and subsequently decays,

emitting its electron in the company of another neutrino. Then the process begins again from the beginning, and leads to a new neutrino emission. . . .

If the temperature and density are high enough, as they are in the interior of contracting stars, the energy losses through neutrino emission will be tremendously high. Thus, for example, the capture and reemission of electrons by the nuclei of iron atoms will transform into neutrino energy as much as 10^{11} ergs per gram per second. In the case of oxygen (where the unstable product is radioactive nitrogen with the decay period of 9 seconds) the star can lose even as much as 10^{17} ergs per second per each gram of its material. The energy losses in this latter case are so high that the complete collapse of the star takes place in only twenty-five minutes.

Thus we see that the beginning of the neutrino radiation from the hot central regions of contracting stars gives us the complete explanation of the causes of stellar collapses, and, since the neutrinos escape all available methods of observation, the origin of the energy discrepancy discussed in the previous section becomes also quite clear.

It must be stated, however, that although the rate of energy losses through neutrino emission can be estimated comparatively easily, the study of the collapse process itself presents considerable mathematical difficulties. It can be said at present only that the beginning of the neutrino emission from the interior of the star will lead to the formation of a dense central core which will rapidly increase in density at the expense of the additional material squeezed into it by the collapsing exterior layer.

For the stars of comparatively small mass (smaller than Chandrasekhar's critical mass of 1.40 sun masses) the process will be stopped as soon as the density of this core reaches a certain maximum value. In this case the result

of the collapse will be represented by a dense white dwarf with a mass only somewhat smaller than the mass of the original star.

If the mass of the star is above this critical value, there is no theoretical lower limit for the possible collapse, and the process will go on with ever-increasing intensity until the material blown away in the form of the expanding gas shell reduces the mass enough to stop the process. In this case the result of explosion will be also a white dwarf, but its mass will be much smaller than the mass of the original star. The rest of the mass will be distributed in the form of a gas nebula around the place of explosion.

Comparing these two possibilities with the description of novae and supernovae given in the previous section, we see that it is very probable that the differences between these two classes of stellar explosions may be due to the difference in mass.

We conclude by indicating the connection of the above theory of stellar explosions with the continuous stellar evolution as described in the beginning of this article. Since the emission of neutrinos leading to the catastrophic collapses of the stars takes place only at very high temperatures, we must expect that it will take place during the contractive part of stellar evolution following the complete consumption of hydrogen. Once the collapse starts, it will not stop until it transforms the star into a white dwarf, and thus covers in a few weeks the entire evolutionary path which would otherwise require many million years.

If the proposed theory is correct, we should not worry that our sun may explode any day, since its hydrogen content is still about 35 per cent. On the other hand, the collapse of the sun, taking the form of an ordinary nova, must necessarily be expected about ten or twenty billion years from now.

THE PHYSICAL AND THE NON-PHYSICAL WORLDS AND THEIR INTERME- DIATE ELEMENTS

By Dr. GUSTAF STRÖMBERG

MOUNT WILSON OBSERVATORY, CARNEGIE INSTITUTION OF WASHINGTON

IN scientific research it often happens that, when a particular field of study has been explored, an impasse is reached. The principal reason is that the limitations of the field have become apparent, although many details still need to be investigated. In general, the fields and their limits are determined by the categories we use in describing the phenomena belonging to the different fields of knowledge. Our knowledge and our thinking are based on our inherited mental equipment, and our ideas and concepts have developed from our primary sense data, analyzed and synthesized by our intellect. Our sense organs give us such data as apparent extensions, separations and changes of visual images, perceptions of colors, sounds, taste, smell, pain, heat, cold, and touch. We also have feelings of happiness and sorrow, we have a conscious will, we have a memory, and we are able to make deductions and find rules for the activities in our mind and, to some extent, in other minds. If we regard science as any kind of systematized knowledge, we may say that each of our sense organs, using this term with a very broad meaning, defines a particular field of scientific research. These fields are all *mental*, because we always start from sense data and phenomena of one kind or another, and, whatever mental operations we perform, the result is still a mental world. With the aid of intellectual intercourse we can in many cases combine the individual, private mental worlds into a *communal* or *intersubjective* mental world, which

we naturally regard as being more fundamental than the private world of phenomena in each individual mind. This is the procedure scientists have adopted in studying what they call the "external world."

Our fields of knowledge fall into two distinct groups. The first is usually based on our sense of vision and is called the *physical world*. The other group contains all those fields the knowledge of which has been primarily derived with the aid of other sense organs, or which are the results of intellectual analysis of a complex nature, and these fields define what we shall call the *non-physical world*. Phenomena belonging to the second group are often called "mental," but this is not a distinctive term, since the physical world, both the private and the communal, must be pictured in categories conditioned by the human mind. There are also elements which lie between the physical and the non-physical world, and we are at liberty to assign them to either one or both of these worlds. These *intermediate elements* are very important, because by studying them we can learn how to pass from one field to another, and we shall then realize the unity behind all our knowledge.

I. THE PHYSICAL WORLD

We shall define the physical world as a field of intersubjective knowledge in the description of which we need only the categories *space* and *time*, and we use them in the form of spatial and spatio-temporal *structures*. The sense

organ involved is usually that of vision, but the eyes themselves play only a secondary role in our space and time perceptions. We can observe space and time phenomena in a dream, for instance, in which case our eyes certainly play a very subordinate role. There are reasons to believe that the organ of space and time perception is located in the rear part of our brain, which organ not only seems to give us immediate perception of *extension* and *separation* of images (mental space), and immediate perception of *duration* and *progress* (mental time), but also makes possible a coordination of our space and time perceptions into a coherent unit. This organ serves as a "mental clock" and gives us the unique direction of the "arrow of time" and makes possible our perception of events as being "now-here" and "then-there."

The idea that our organ of vision (eyes and brain) can give us complete knowledge of the physical world has recently been emphasized by Eddington.¹ He writes: "Ideally all our knowledge of the physical universe could have been reached by visual sensation alone—in fact, by the simplest form of visual sensation, colorless and non-stereoscopic." In more detailed studies, however, we use many kinds of instruments to aid our vision and to measure, directly or indirectly, distances, displacements, time intervals, and motions. Such instruments are microscopes, telescopes, measuring rods, micrometers, theodolites, thermometers, balances, clocks, galvanometers, photographic cameras, spectrometers, and so on. An important mission of the eyes is to convert the physical phenomenon, radiation, into the non-physical phenomena, sensations of light and color. Tactile sensation can also be used in the study of physical phenomena, although the tactile sensations them-

¹ "The Philosophy of Physical Science," p. 197. Macmillan, 1939.

selves, like colors and sounds, belong to the non-physical world.

Kant realized clearly that in our mind we have an inherent, latent knowledge of space and time. The science of physics is not concerned with the metaphysical problem of the existence and nature of space and time. Physicists are particularly interested in *structures* in space and time, which Eddington² clearly expresses in the following words: "Since the external world is introduced as a receptacle of structures, our knowledge of it is limited to structural knowledge; and physical science is the study of this structural knowledge." This can be most easily seen when we describe an electromagnetic field. The mathematical description is given by Maxwell's equations, which can be visualized as representing a system of lines of force. Obviously the description is that of a structure with space and time properties, or, better expressed, a *structure in space-time*. The last type of description was introduced by Einstein and is based on the measurements of many individuals having different positions and motions, and refers hence explicitly to the communal or intersubjective world. The structure of an electromagnetic field is characterized by certain well-defined "singularities" or "sources," where the lines of force seem to begin or end.

The *particles* of physics can be described in two different ways. On the one hand they are *sources* in gravitational or electrical fields, and, being important characteristics of the field, that is, of a space-time structure, can be regarded as belonging to the physical world. On the other hand, the particles have rest-masses, angular momenta, and in some cases at least, electric charges,

² *Op. cit.*, p. 209. Eddington uses the term "structure" in the sense in which it is defined and investigated in the mathematical theory of groups and does not explicitly limit himself to structures in space and time. Cf. p. 147 of Eddington's book.

of definite amounts, or integral multiples of such amounts, a fact which indicates that they have properties which can not be expressed in terms of our concept of space and time alone. The particles themselves therefore transcend the physical world as previously defined. They seem to have their "roots" in a non-physical world, and they emerge into the space-time world as sources in a field of force. They belong to the class of intermediate elements mentioned before.

When we speak about the location and motions of particles, or of matter in general, we are referring to measurements and sensations of certain types. We never observe the particles themselves, but infer their position and motions by indirect methods, as, for instance, by their effect on light beams or from tactile sensations. The phenomena we observe are associated with their fields and not with the particles as such. It is customary to assume that the elementary particles, like electrons and neutrons, have no internal structure. In making this assumption we have relinquished all rights to regard them as physical objects and have actually placed them beyond the physical world. In a perfectly uniform medium, location, separation, distance, and motion can not be defined and are therefore meaningless concepts. Similarly, time-intervals are non-definable when nothing observable happens. A space without definable structure, and a time during which nothing observable happens seem to be meaningless concepts. We may therefore regard structureless and inactive particles as "openings" in the field or structure. To these openings we can not apply our ordinary concepts of space and time. A similar idea has been expressed by Weyl³ in his important article, "Was ist Materie?"

Let us assume, for instance, that we

³ *Die Naturwissenschaften*, 12: p. 611, 1924.

have a homogeneous electron beam passing through two slits, close together. We expect then to find the well-known diffraction effects, and the diffraction pattern can be interpreted as a probability distribution of momenta and positions, and the "cells" in the distribution are defined by the value of the quantum of action. This must also hold for a single electron, and the diffraction pattern can then be regarded as a potential probability distribution of momenta and positions of the electron. It is now known that an electron is not a recognizable individual that is now here and now there. According to what we have said before, an electron which does nothing is a meaningless idea. We have therefore no right to speak about an electron moving through one slit rather than the other, since no observable effects are produced at the slits. (If such effects were produced, the interference pattern would be greatly modified.) An epistemologically sound imagery should therefore not involve any moving electron at all, but a motion of a "field structure," a "wave system" or a "wave packet" with potential properties and with dimensions much greater than that of the electron itself. This wave system interacts with the wave systems surrounding all particles of matter and is therefore affected by both slits. Somewhere in these wave packets and at some time defined by a probability function we expect the mysterious thing we call an electron, of whose ultimate nature we know nothing, to jump like a "jack-in-the-box" into the physical world and then to become recognizable by definite effects on the field.

It is very significant that the effects of electrons and photons are *discontinuous events*, and that, when something observable happens, a definite amount of action emerges into the physical world, and is later temporarily lost to this world. It is for this reason we speak of

"electron jumps" and "excitation steps." When no such events occur, an electron or a photon is in principle unobservable and can therefore well be regarded as non-existent. It seems that it is only the *probability* of its emergence in the world of space and time that can be represented by mathematical functions. Some of the conservation laws of physics may well have only statistical validity. The *wave functions* in multi-dimensional configuration space, which are needed to describe phenomena in which many particles are involved, can be regarded as mathematical symbolic expressions which have no counterpart in the physical world. They are derived from space and time measurements and must again be converted into such data when comparison is made with actual measurements. They belong to the mathematical implements needed in the science of physics, but not to the physical world of our immediate experience.

It may seem strange to many that, in our analysis, matter has lost its "substance" and nothing is left but a space-time structure. This profound change in our primitive notions is a consequence of the growing powers of our thinking. We have learned that physics starts with *shadows* and therefore never reaches the substance; it describes *form* and *changes in form*, but not the actual content of our experience. For instance, when we study an x-ray photograph of a crystal, we find shadows which our analysis tells us are produced by exceedingly small elements arranged in well-defined formations. We have not the faintest idea of the intrinsic nature of these elements, because we have never had any actual "contact" or "association" with them. (Such contacts can only be established with certain nerve cells in our own bodies, as will be explained later.) We see the formations as recurrent shadows, and we deduce rhythmic vibrations, and a strange "music" is emitted which we

picture as a radiation. We wonder whether the structure and the vibrations are due to something inherent in the individual particles, or in the field, or are arranged by an unseen marshal and bandmaster, or whether they are modes characteristic for our own mind, which itself may determine the rules that apparently govern the activities we perceive. Our vision informs us about structural characteristics only, including numbers of similar units and groups with identical configurations, but the cause of the structural properties and of the uniform elements is not revealed by our sense of vision. Nothing should prevent us, however, from using our intellect to the best of our ability to interpret our observations and to look behind the screen on which the shadows move.

Fields of force, radiation, waves, and particles are *constructs of the human mind*. They are invented by ingenious story tellers to describe and to explain the observed shadow play; in pictorial form for most of us, in mathematical form for people interested in quantitative research and in practical applications, and in more abstruse terms for the philosophically minded. Like all allegories the stories are expressed in terms and symbols appropriate to the understanding of the people to whom they are presented, and they emphasize particular features of our experience and disregard others. The pictures and symbols are very instructive and helpful, and they tell us among other things that, beyond the play of shadows we observe in common with others, there exists another world, less evanescent and more fundamental than that revealed by our observations in the realm of space and time.

All this may at first seem of some metaphysical interest, but of little practical importance. But the distinction between a physical and a non-physical

world, and the idea of elements intermediate between them, can be applied to a number of other fields of knowledge, in particular to those connected with life and with consciousness. We shall then see how these new ideas in physics can help us to understand the organization in the living world and the relationship between mind and matter, problems which have hitherto defied all attempts at solution.

II. THE NON-PHYSICAL WORLD

The non-physical world, like the physical world of space and time, is a mental world and exists in the first place in the consciousness of each individual. The sense organs and brain centers involved are of the most varied types; in fact, all sensations which are not of extension, separation, structure, structural changes, vibration and motion belong to the non-physical world. Colors, sounds, smell, taste, pain, touch, feelings, emotions, memories, conscious will, thoughts, and purposeful activities belong to this world. Life itself, apart from its purely physical, that is, structural, aspect, belongs to the non-physical world. Life, *as we see it*, is a play of moving shadows in our consciousness and hence belongs to the physical world. The purposeful organization behind this play of shadows, the life we feel in our bodies, and the life associated with conscious activities, on the other hand, belong to the non-physical world.

It is, of course, impossible in a short article to describe all the phenomena and concepts belonging to the non-physical world. Many of them, together with a general survey of the problem, have been described in a non-technical book⁴ recently published. I shall here describe only two types of phenomena which are characteristic for the whole field and are of great importance for our understanding of the universe in its wider aspects.

⁴G. Strömberg, "The Soul of the Universe." Philadelphia: David McKay Company, 1940.

A. THE ORIGIN OF COLORS

We all know, or think we know, what radiation is. The physicists agree that it is an electromagnetic phenomenon, and we know a great deal about the physical properties of radiation. Radiation can produce chemical and electrical effects, but it can also produce a sensation of light or color. We have definite ideas about the mechanism involved in the production of the physical effects by radiation, but when we come to an explanation of color sensations, our mind is completely blank. We rarely give any thought to the problem how the transformation of radiation into colors is accomplished; in fact, the general relationship between physical and mental phenomena is a problem which long ago was given up as insoluble and even incomprehensible. A solution of this age-old problem would open up a whole new world for our investigations and might well change our whole outlook on both life and mind. Hence it is of importance to make some serious efforts to elucidate this important problem.

The generally accepted idea is that the radiation produces some chemical changes in the retina, and the unstable chemical substances thus produced stimulate the rods and cones at the ends of the optic nerve fibers. These nerve fibers are associated with one or more ganglia, and the nerve fibers can be regarded as extensions from nerve cells in the ganglia. The nerves with cones at their ends give us color sensations, whereas the rods are responsible for gray or colorless sensations and are sensitive to faint light. To simplify our description we shall in what follows regard "white" as a particular kind of color sensation.

The word "stimulation" is a convenient term, but it does not tell us anything about the origin of the colors. We have no more reason to believe that atoms and molecules can by themselves give us a sensation of color than that they can feel and think. If atoms could have such

strange faculties, it is difficult to understand why they can be effective only when they vibrate in certain ways and form certain peculiar structures, like those in the optic ganglia and in the brain. The structure of the optic ganglia is determined by hereditary elements in the human ovum, and these elements we shall call the *color genes*. In fact, many believe that we can definitely locate the potentiality for red vision in the X-chromosomes, of which a man has one and a woman has two in all living cells of their bodies. It is necessary to assume that the field structure of the color genes in the ovum has expanded or become developed at certain definite places in the retina of our eyes. These fields guide the motions of particles and have a specific structure of a highly complex type. In living elements, like the optic ganglia, the field can not be conditioned by the incorporated material elements alone, *the field must have a structure of its own* and determines in itself the molecular structure and vibrations. Our first conclusions are then that the *fields* in the ganglia, rather than the incorporated material elements, are essential factors in the mechanism we study, and that these fields exist in an extremely contracted or potential form in the fertilized ovum.

All fields of force must have *sources* which define their properties. In an electric field the sources are in the electrons and in the atomic nuclei; in a gravitational field the sources are in the atoms, probably in the neutrons. In analogy with the ideas expressed before, we shall regard the field as the physical or space-time aspect of a phenomenon. The corresponding sources, on the other hand, belong to the non-physical world and represent the *non-physical essence of the activities*, which essence, like that of electrons and other particles, emerges at fairly well-defined loci into the physical world of space and time. It then

appears in the form of fields with certain specific physical properties, and the points mentioned we picture as singularities in the field. The properties of the fields are conceived as actual and physical, whereas the properties of the sustaining sources are potential and non-physical.

A field of force has a certain energy content. Part of this is in the field and part is in the sources, and the latter part can be measured by the rest-mass of the sources. The masses of different types of sources differ greatly. Electrons have very small rest-masses, neutrinos probably very much smaller, and photons none at all. "Living sources" have probably no rest-masses at all, and all their energy is then in their fields. When a "living field" disappears from the physical world, energy is lost, and, when it emerges or grows, a certain amount of energy is absorbed and organized. The fields in atoms and molecules can absorb radiant energy. In this case the structure expands or is split, and these phenomena we call excitation and ionization, respectively. In the case of living fields the energy needed for their emergence and expansion can be obtained in several ways. The most common way is by chemical substances having a structure with a frequency pattern similar to that of the field itself. Such substances we shall call *hormones*, because they act in the same manner as the hormones which stimulate growth and embryonic development and enhance the activities of our organs. In nature, hormones are usually formed by resonance effects, in which a part of the frequency pattern in a living field is transferred to and stabilized by a non-living, molecular structure.

Now we can take a second step in our analysis of the relationship between radiation and color. The radiation transmits energy and definite frequencies to certain chemicals in the retina, and

chemical hormones, characterized by definite frequency patterns, are formed. Some of the vibrations in the hormones are in resonance with vibrations in the "living fields" or "living wave systems" in the ganglia, and these fields, which have *slowly* expanded in the retina during the embryonic development of the optic cup from brain substance, absorb energy, and the vibrations are quickly amplified. This causes a *sudden* expansion of the living fields in the optic ganglia and their associated nerve fibers, an expansion which can be directly observed as a progressive change in the field structure *outside* the nerve fibers. There is now no longer the best possible fit between the electrical fields of the molecules and the structure of the living fields. The vital "holes" in the latter are no longer occupied by material elements, and a strange thing then happens. *The gate to the "universal realm of colors" is temporarily left ajar, and we have a glimpse in our consciousness of a color or a combination of colors.*

This may at first seem a strange explanation of the origin of colors. But a little reflection tells us that colors can not emerge spontaneously through a property of the molecular structure in the optic ganglia or in the brain. Colors must have an ultimate origin, in some way associated with the origin and potential structure of the color genes in the ovum and in the race. (This has an important bearing on the origin of sense organs and of life.) Although the nerve cells which the biologists and the physiologists study in their microscopes are shadows and nothing else, these shadows have a *meaning*. They are symbolic of something which we can only picture by an imagery developed by experience and conditioned by *our* type of intellect. We now picture the nerve cells as points of "contact" between the space-time world and another "world" or "dimension of Cosmos." The pictures we have are, of

course, imperfect and inadequate, but they give us, in symbolic form, at least, some faint idea of the mechanism involved in the emergence of color through radiation, and of the relationship between matter and mind in general.

Neurones are peculiar elements in our bodies. When a neurone is stimulated, it always reacts in the same way, no matter how the stimulation is brought about. The optic ganglia can be stimulated by chemicals, or by pressure, or by electrical excitation, and they then give us sensations of color, but never anything else. The same holds for the nerve cells which give us sensations of sound, taste, smell and so on.

If the theory here presented is correct, it follows that *certain neurones have a consciousness of their own*. This consciousness is ordinarily associated with the general consciousness in the animal, and the associations are in the space-time world of our vision observable as neural connections and impulses. An excised optic ganglion, if it could be kept alive *in vitro* and properly stimulated, should therefore be capable of conscious color sensations. Other isolated neurones, if kept alive and stimulated, should give sensations of smell, others of taste, others of touch, and others of sound of a particular pitch. Systems of detached neurones may give feelings of pain and pleasure, and perhaps even of some simple type of emotion, although, of course, their former owner would be completely unaware of the new experiences in his one-time neural equipment. It is obviously impossible to get conclusive evidence of a consciousness in systems detached from the observer, but the behavior of some simple animals when touched, the effect of color-sensitive spots in the skin of animals, and the transplantation of eyes, with rebuilding of a retina and restoration of brain connections and sight, give some indication of the truth of this asser-

tion. The idea that man is an organized colony of simple animals is not foreign to biologists; in fact, we may well regard each of our cells and some of our organs as individual "animals." But the idea that our mind may be an organization of units having a consciousness of their own is a startling result of this analysis and leads to interesting conceptions regarding the nature and properties of our *general consciousness*,⁵ which we may well call our "soul."

We have said that the atoms in the optic nerve cells keep the gates to the realm of color closed under normal conditions. The matter in the nerve cells in our brain can be expected to act in the same way and should therefore *restrain* rather than facilitate mental activities. (In this way we obtain a physical basis for Bergson's theory of memory.) Only a few of the gates to the non-physical world are open at any particular moment, and this fact prevents an avalanche of feelings, thoughts, and memories from descending upon our mind. Carried to its logical end, this idea can be used as a basis for the theory of the survival of the soul at death. Without matter and hormones with the right structures and vibrations, the living fields in our brain would shrink to a point. They would then disappear from the physical world of space and time, being submerged into the non-physical world from where they originally came. Our soul with all its memories would then not be annihilated at death; on the contrary, its capabilities would be much greater than when it was loaded down by inert matter. But if there is no time in the non-physical world, it is difficult to conceive of any actual development.

In the explanation of colors given above, we assumed that colors are irreducible elements, not only in our own minds, but also in *Cosmos*, that is, in a well-ordered and all-embracing universe.

⁵ *Op. cit.*, chapter 11.

But it would be irrational to regard *Cosmos* as a *sum* of qualities, like space, time, colors, sounds, feelings, and thoughts. We have recently learned that space and time, which for our minds appear as completely different categories, in the external world form a more comprehensive unit, space-time. We have every reason to believe that *all* the attributes of *Cosmos* are interrelated and form a unified whole. It seems that the human and animal brains have elements originating in *Cosmos* and still retaining their association with their ultimate, world-transcending source and origin, the origin determining the physical structure as well as the non-physical qualities of the elements. Our brain is an instrument, operated by hormones, which does not of itself produce mental qualities, but *reproduces* certain structural and non-structural cosmic qualities. Therefore we observe *Cosmos* in the form of aspects, of which space is one, and time is another, color is a third, pain and pleasure are others. But *Cosmos* itself is one and indivisible, and it is due to a peculiarity of *our* mind and *our* nervous system that we picture it in the form of aspects and categories. When we look at a living brain we find structural properties originating in *Cosmos*. When we study our own mind, we find sensations, emotions, ideas, rules and relations. In both cases we study aspects of the same entity, a well ordered *Cosmos*. This is what the ancients called *The Soul of the Universe*.

B. ORGANIZING FIELDS

Purposeful activity is characteristic of the human race and of many animals. In accordance with the ideas previously described, our conscious knowledge of such activities presupposes a similar faculty in *Cosmos*, a faculty which in my book I have called the *Cosmic Will*. We said before that both the structure and the functions of the nerve cells must be de-

terminated by immaterial and non-physical, that is, massless and structureless, sources originating in Cosmos. If this hypothesis is correct, it must be applicable to all kinds of organization in plants and animals. I shall here give a few examples of such organizing activities, referring interested readers to the more detailed analysis in my book.

In the embryonic development of all animals except Sponges and Protozoa a gastrula is formed by invagination of the blastula. The coordinated motions of the different parts of the embryo during gastrulation can obviously not be due to the molecular properties in any particular cell or cell group. Whether we like it or not, we must think of the motions as due to a guiding field (the source of which is probably centered in the region of the blastopore), which has some superficial similarity to a vortex system. A very characteristic property of the gastrula is that its parts, when transplanted into a new surrounding, for a time continue to change their shape as if they were still connected with the original field. This astonishing "persistence of activity" is quite foreign to our classical ideas of fields of force. A living field, like other guiding fields, is a space-time structure, but it differs in many ways from an ordinary electromagnetic field. The time element in an electromagnetic field is connected with the space elements by a certain constant conversion factor, the velocity of light. The changes in an electric field are therefore transmitted in space at a speed which we, with a stature of five or six feet and with a mental clock having a vibration period of about a tenth of a second,⁶ naturally regard as tremendous. An electromagnetic field in which the sources have become neutralized therefore quickly disperses its energy in the form of radiation. In a living field there are not only rapid vibrations, evidenced

by the incorporation of particular molecular structures, but also a progression which we, with our inherited standards, regard as "slow." The progressive changes we observe in embryonic development, for instance, reflect these slow changes in the field. A fraction of a living field, even when separated from its sources, can therefore for a while continue its normal development, because the dissipation of the energy in the field proceeds at a slow rate. Mechanical disturbances and high temperatures can be expected to increase the rate of dissipation. This slowness of some of the changes in living structures is responsible for the strange teleological properties in the development of living organisms, a purposeful development which is entirely incomprehensible from the standpoint of ordinary mechanics and electro-dynamics.

Spemann⁷ introduced the term "organizing field" for the cause of the concerted activities which make possible the formation of a complete, highly organized animal. In the vertebrates this field seems to reside in latent form in the dorsal lip of the blastopore and spreads during gastrulation to the dorsal mesoderm. It induces the formation of nerve tissue in the neural plate which is underlain by this mesoderm. In vertebrates the spreading influence in the mesoderm is observed as a formation of a notochord with somites, which seems to be the "root" or "stalk" from which the organizing field expands. At the beginning of the gastrulation the potential fields exist as dimensionless sources in the stagnation point of the "gastrula vortex." This point is in the dorsal lip of the blastopore and is well defined in many animals. The fields of these sources are developed under the influence of simple hormones (*e.g.*, oxygen) and interact with the *de Broglie* waves

⁷ H. Spemann, "Embryonic Development and Induction," Chapter XV. Yale University Press, 1938.

⁶ *Op. cit.*, pp. 176-180.

inherent in all matter. Because of this interaction with matter, the sources and their fields must follow the rapid cell flow in the immediate neighborhood of the stagnation point and are transferred to the mesoderm. These fields, when fully expanded, determine the structure and functions of the nervous system with its central organ, the brain, and its multitude of inter-connected neurones.

The division of an embryo into two new embryos is another indication that the living fields we study are of a type different from the non-living guiding fields. Before gastrulation begins we can divide an embryo, that is, we can make two complete replicas, by making a constriction in a median plane. The division is facilitated by shaking the fluid mass, which shows that the organized fluid matter exercises a stabilizing influence on the field. The primary effect seems to be a splitting of the potential notochord. The splitting ordinarily begins at its anterior end and may therefore result in the formation of two heads instead of two complete embryos. A complex guiding field can obviously not be split, because this splitting involves a complete duplication of tremendously complicated potentialities, as exemplified by our brain and our skull, and physical space has not enough dimensions for such a profound process, which must even involve a duplication of mental potentialities. The "splitting" must therefore occur in the non-physical world; in other words, it is the non-physical sources and not their fields which are split into two equal parts. During the very moment of splitting the sources must be dissociated from the energy patterns or fields they previously possessed, since these fields act as restraining bonds linking the sources with

the physical world of space and time. If the processes of life are due to effects of living fields, the strange process we call *death* must be due to the disappearance of such fields from the physical world. In particular we conclude that when chromosomes are split during cell division, they actually die, but are immediately reborn in duplicate form. The first stages of the separation of the daughter chromosomes is caused by a progressive expansion of their living fields, in which process "The Exclusion Principle for Living Elements" (analogous to Pauli's Exclusion Principle for electrons) becomes effective.

In my book I have referred to the more complex sources, in particular those which produce organization by means of nerve systems, as *genii*. It seems to me a good name, but biologists would probably object to the connotation of mystery which this name implies. Many other names could be used, but in any event some name has to be adopted to represent the potential causes of organization fields and of mental qualities in living organisms.

Matter and life and consciousness have their "roots" in a world beyond space and time. They emerge into the physical world at certain well defined points or sources from which they expand in the form of guiding fields with space and time properties. Some of the sources can be identified with material particles, and others with the living elements responsible for organization and purposeful activities. Some of them exist in our brain as neurones, and some of them have a very intimate and special association with their ultimate origin. They are the roots of our consciousness and the sources of all our knowledge.

BOOKS ON SCIENCE FOR LAYMEN

CONFESSIONS OF A MATHE- MATICIAN¹

HARDY'S "Apologia pro Vita Sua" is ludicrously reminiscent of Cardinal Newman's famous history of his personal religious opinions. Unlike the late cardinal's pious effusion, however, Hardy's somewhat defiant challenge to the impure among mathematicians has a stimulating dash of satire occasionally, broadening into uproarious farce comedy in the final section. Hardy's sardonic confession of how he ever came to be a professional pure mathematician may be specially commended to solemn young men who believe they have a call to preach the higher arithmetic to mathematical infidels.

With his usual clarity the author explains several simple examples of what he calls "real" mathematical theorems. All are within the comprehension of any one who has had a few days of elementary algebra. Contrasted with "real" or stainlessly "pure" mathematics, is the baser kind, "useful" or applied mathematics, and we are shown why "pure mathematics is on the whole distinctly more useful than applied." This of course is an immediate corollary of a classic paradox of G. K. Chesterton's. We learn that when the mathematical physicist wants to be useful, "he must work in a humdrum way. . . . 'Imaginary' universes are so much more beautiful than this stupidly constructed real one. . . ." Well, God, not the mathematical physicist, must take the blame. And this brings us to what is perhaps the most remarkable passage in the book. It is a statement of Hardy's mathematical creed:

I believe that mathematical reality lies outside us, and that our function is to discover or observe it, and that the theorems which we prove, and which we describe grandiloquently as our "creations" are simply our notes of our observations. This view has been held, in one

¹ *A Mathematician's Apology*. G. H. Hardy. vii + 93 pp. \$1.00. 1940. Cambridge University Press (Macmillan).

form or another, by many philosophers of high reputation from Plato onwards. . . .

Indeed it has. But not by all. The impregnable strength of this creed is that it can be neither proved nor disproved. We may take it or leave it as we please. Congenital believers will embrace it with joy, possibly as a compensation for the loss of the religious beliefs of their childhood. Some, like Bertrand Russell, who once clung to it, will "abandon it with regret." The majority will probably ignore it as a museum piece from an incredibly credulous past.

The mathematician's apology, though franker and less casuistical than the cardinal's, deserves a place on the shelf with the churchman's masterpiece of special pleading. Even those who dislike what the mathematician says may like the enthusiastic way he says it.

E. T. BELL

MENTAL COLLAPSE IN WAR-TIME¹

In the United States the importance of the subject of this book is indicated by the following aspect: According to official figures furnished through the courtesy of Dr. Martin Cooley of the Veterans' Administration, the approximate cost of paying compensation or pension to World War Veterans suffering from "Other Neuropsychiatric Diseases," which were preponderantly neuroses, was \$28,708,928 for the fiscal year 1940. These cases numbered 54,364 and showed a steady increase from 1923 when they numbered 14,543; and their cost in that year was \$5,793,420. Their total compensation cost for eighteen years from 1923 to 1940, inclusive, was \$347,429,052. These were service connected cases and did not include psychotic patients. In addition to these compensation figures, the cost of hospitalization of neurotic patients, service connected and non-service connected, for the fiscal year 1940, was approximately \$1,400,000.

¹ *The Neuroses in War*. Emanuel Miller, editor. xii + 250 pp. \$2.50. 1940. The Macmillan Company.

In Great Britain in the early years after the 1914-1918 war, there were more than 100,000 neurotics receiving pensions for this disability, and the cost was roughly \$40,000,000 annually.

Another aspect of this problem is the elimination of potential neurotics before they are admitted to the military service—a difficult task which can be only partially successfully performed, but in which the help of neuropsychiatrists is usually available if requested by local selective service boards and Army induction centers throughout the country.

Other aspects are the baleful effect of these neurotics on the morale of their associates; the care and treatment in the Army, the object of which is to return them to duty if possible, and if not, to discharge them; and last but not least perhaps, the problem of the neuroses among the civilian population.

It became an axiom in the first world war that the number of war neuroses ("shell shock" cases) was in the inverse ratio to the morale of a military organization. During the past year the small number of neuroses among the civilian population of Great Britain has been a matter of interest, comment and surprise. Probably the magnificent morale of the British nation has been a major factor here.

Unfortunately, this book, "The Neuroses in War," was written before the mass air raids on Great Britain were begun. However, it presents the digested experience of its numerous authors in the first world war, and is written with authority and with the object of application to current military and civilian war neurosis problems. While apparently intended primarily for physicians, there is much in it that the intelligent layman can grasp and will find interesting and profitable. The chapter on "The 'War of Nerves': Civilian Reaction, Morale and Prophylaxis," is admirable, both in content and style.

ROSCOE W. HALL, M.D.

NATURAL HISTORY OF THE HONEYBEE¹

In this book Mr. Teale has presented a well-written and fascinating account of the life of the honeybee embellished by many of his excellent photographs.

One of the earlier chapters discusses briefly the life histories of some of the solitary bees and of the other two groups of social bees—the stingless honeybees of the tropics and the bumblebees of the temperate regions. Later chapters take up the activities of the domesticated honeybee from spring to fall. There is a chapter discussing the morphology of the honeybee in a non-technical manner, and such morphological adaptations as the pollen-gathering apparatus and the "wax plates" are given due mention. Another chapter tells of von Frisch's classic experiments on the senses of bees proving that they have a definite perception of various colors and scents. The various enemies of bees such as the bee louse, wax moth, dragon fly, toad, skunk and others are the subjects of another section. The more important technical and popular books on apiculture and the life of the honeybee are discussed briefly near the end of the book. The final chapter entitled "Photographic Postscript" will be of interest to those having photography for a hobby as the author describes his equipment and the methods used to obtain the pictures illustrating his volume. A special word of praise should be said for Mr. Teale's photographs—the numerous pictures are distinguished for their sharpness and interesting subject-matter.

This book is recommended unhesitatingly for the layman who is interested in insects, though it should be understood that it is not a treatise on apiculture. The information contained is sound and the book should make excellent reading for high-school and college students of biology.

KARL V. KROMBEIN

¹ *The Golden Throng*. Edwin Way Teale. Illustrated. 208 pp. \$3.00. 1940. Dodd, Mead and Company.

ON THE SOCIAL DISEASES¹

IN the past few years much effort has been expended in attempts to acquaint the public with the nature of the two most significant venereal diseases: syphilis and gonorrhoea. Unfortunately, the majority of books for laymen on this subject have been either malodorously sanctimonious, crucifying the innocent with the "guilty" and creating dangerous phobias through prudish mystery, or they have been prepared by "feature writers" with little knowledge of their subject. However, in this very recent volume on what the layman should know about gonorrhoea and syphilis, we find that Dr. Irving Simons possesses the rare qualities of medical accuracy, keen and scientifically dispassionate sociologic evaluation and ability to explain in simple, non-technical language the natural history of these two infections.

The volume is divided into two parts, considering the two diseases separately. After describing the historical backgrounds, the author discusses the causes of infection, the microorganisms and the modes of transmission. Next are considered the diagnosis and consequences of the diseases. Methods of treatment and their limitations and potentialities are very well described in such manner that the lay reader will not be encouraged to attempt self-medication (a frequent cause for delay in the institution of proper medical management and also an important factor in enhancing the chances of complications in gonorrhoea). The importance of prompt medical attention is stressed effectively. One is most favorably impressed by the sane clarity and simplicity with which these problems are discussed.

The lay public interested in obtaining accurate information concerning these serious diseases is to be congratulated upon now having available this excellent

¹ *Unto the Fourth Generation: Gonorrhoea and Syphilis*. Irving Simons. Illustrated. xiv + 243 pp. \$2.50. 1940. E. P. Dutton and Company.

book. The style is lucid, precise and flowing. There are no sentimental outbursts or exaggerations. The scientific facts are sound. Despite the simplicity of the language, one does not have that disagreeable feeling that the reader is being talked down to and his intelligence insulted by infantile phraseology, so often a major source of irritation in so-called "scientific" books for laymen. There is some unnecessary repetition which may well be avoided in future editions.

The book can be read with profit by all non-medical persons concerned with venereal disease, such as officers of the Army and Navy, personnel executives, sociologists and teachers. Physicians can and should recommend it to their venereal disease patients; its study should improve the results of treatment by enabling the patient to understand it more fully and thus cooperate more effectively. It is too sane and honest to appeal to bigoted reformers who would deny that mankind is biological. As Clarence Day whimsically told us: If we have fallen from the angels, we have indeed fallen far; if we have risen from the ranks of other species, mankind has done pretty well. We must not expect that venereal disease will or can be eradicated by purely sociologic "policing." But there is every reason to hope that the science of medicine may some day find much more efficient methods for cure and also of prevention, possibly by specific prophylactic immunization, such as has been accomplished with smallpox and/or diphtheria. In many respects syphilis is the less destructive of the two diseases. Despite the misleadingly suggestive title of Dr. Simons's book, "Unto the Fourth Generation," there are far fewer "damaged goods," or congenital syphilitic stigmata, than is generally believed, due to nature's selective protection by insuring that the truly unfit shall not survive, and to the great art of medicine.

EDWARD J. STIEGLITZ, M.D.



WALTHER NERNST IN 1934

THE PROGRESS OF SCIENCE

WALTHER NERNST, A GREAT PHYSICIST, PASSES

IN the spring of 1896 the new Institute of Physical Chemistry at Göttingen was dedicated with the thirty-year-old Walther Nernst as director. Arrhenius was the chief speaker and guest of honor. There were seventeen of us advanced students in that laboratory that spring, sixteen of whom called themselves physicists and one a chemist. Six of the seventeen were Americans. All of us "sat in" on Nernst's general lectures which covered the material in his new book on "physical chemistry" upon which his reputation at that early age had largely been built. That book was notable in its grasp of the physics of the day with enough of chemistry to justify the title. The group in the laboratory regarded Nernst as essentially a physicist, well endowed with physical ingenuity and insight and a moderate knowledge of analytical procedures, who had had the ability to get a new laboratory built for himself by capitalizing on the recent discovery by chemists under the lead of Ostwald (Nernst had been with him at Leipzig) of what physics had been doing throughout the nineteenth century.

Nernst himself would not quarrel with the foregoing estimate even though it might seem a bit extreme. Nernst himself was a man of extremes. As a student he had spent his first two years at the university in "bummeling" as a typical member of one of the "fighting corps," the record of which showed in the scars on his face, acquired in his "mensur duels."

After his "bummeling" period he settled down to work intensively and acquired the grasp which gave him the standing, as well as the academic post, which he had won at the early age of thirty. His reputation at that time rested primarily upon his newly pub-

lished book, psychologically well timed, and his design of a modification of the Wheatstone's bridge. This made it possible to balance out the capacities as well as the resistances of the arms of the bridge and thus improved the measurement of the dielectric constants of solutions, for example. He was a little fellow with a fish-like mouth and other well-marked idiosyncrasies. However, he was in the main popular in the laboratory, despite the fact that in the academic world he nearly always had a quarrel on with somebody. He lived on the second floor of the institute with his wife and three young children. As we students came to our work in the morning we would not infrequently meet him in his hunting suit going out for some early morning shooting.

He assigned and supervised most, though not all, of the problems going on in his laboratory. He was at that time working on the "Nernst lamp," which later brought him excellent commercial returns. I did some work there at his suggestion on the dielectric constants of emulsions. After my return to the United States I sent him the experimental results and included in the discussion of them an attempt to develop a theory not then in the literature of the anomalous dispersion of short electromagnetic waves. Nernst separated the theoretical part of the article from the experimental, sent the latter to the *Annalen der Physik*, and returned to me the former with the comment that he did not feel competent to pass on its validity and the suggestion that I try to get further tests of the theory and then send it in independently. Drude was at that time editor of the *Annalen* and the author of the current theory of anomalous dispersion. He published at once the experimental article, drew from it the same

conclusion I had reached as to the inapplicability of his theory to such cases as those with which I was concerned and being entirely unaware of my theoretical work, developed exactly my equations, though with greater elegance than I had used, and published the new theory with due acknowledgment that he had got the suggestion for his article from my paper found in the preceding issue. The incident furnishes a bit of evidence that Nernst's greatest strength was in physical insight rather than in theoretical analysis.

Nernst had been in Göttingen but a few years when he accepted the directorship of the Institute of Physical Chemistry at Berlin. I again saw much of him there in the summer of 1912 when I found many more students attending his lectures than in Göttingen days. Excellent work too was going on in his laboratory, particularly on specific heats at low temperatures. This was the field in which his physical insights—his hunches—were most successful. At this time we were all trying to unravel the intricacies of the quantum theory, and specific heats showed us not only that equipartition had to break down, but just how it broke down. The third law of thermodynamics formulated at about this time is unquestionably the greatest monument to Nernst's scientific insight. He had some bad hunches in the field of cosmic-rays and the amount of energy he expended in his later years in trying, under the stimulus of the commercial motive, to develop a pure-toned piano, represented, so I always thought, very bad judgment, but *the third law of thermodynamics is enough to give him a seat among the immortals.*

His greatest weakness lay in his intense prejudices and the personal, rather than the objective, character of some of his judgments. An incident of 1912 illustrates. He had been entertaining me in most friendly way that summer and he was at that time preparing a new edition of his chemistry. I had just brought my work on e to what I thought a dependable conclusion. He asked me if I would not write that chapter of his new edition for him. I did so and of course had to deal with the work of others as well as of myself. He had recently come back from the first meeting of the Solvay Congress, at which Perrin, who preceded Nernst on the program, had consumed so much of Nernst's time as to greatly enrage him. He accordingly gave instructions to have Perrin's name expunged completely from the new edition of his book.

In 1931, when he was occupying the altogether logical post of director, now, not of the Institute of Physical Chemistry but of Physics, in the University of Berlin, he drove me through the city in his single-seated automobile. The quite vigorous and uncontrolled way in which he berated other drivers who, as he thought, got in his way, seemed to me an illustration of the way age in general tends to intensify the weaknesses which to some extent we have sometimes been able to hold in check in our earlier days. In Nernst's case the objectiveness of science made little headway against the intense prejudices of the Prussian.

Politically Nernst remained a Prussian of the Prussians—a strange mixture of the virtues and the vices of his race.

ROBERT A. MILLIKAN

THE AMERICAN ASSOCIATION CARRIES ON

IN spite of the direct involvement of the United States in the World War, the American Association for the Advancement of Science and thirty-nine of its

affiliated societies will hold their planned meeting in Dallas, Texas, from December 29 to January 2. The decision to go forward with the meeting does not

imply that the officers of the association think that science is something wholly apart from the currents of life. On the contrary, the decision rested on the fact that science is producing a strong tide that is carrying civilization forward although now and then, as at present, storms produce tumultuous waves on its surface.

So rapid has been the development of science that it is impossible to realize its importance in human affairs. Too often we think of Archimedes, serenely drawing geometrical figures in the sand when Syracuse was sacked by the Romans in 212 B.C., as the typical scientist wholly aloof from the world and wrapped up in abstract speculations. Even on the abstruse work of Archimedes, history has placed its stamp of approval. But not only are scientists of the present day carrying on investigations of the fundamental properties of the universe, but they are making direct contributions of

the highest importance to the national defense. Many members of the association will not attend the Dallas meeting because of their services to the Government. They have not been drafted; they have volunteered and have accepted any assignments that have been offered. Those who are carrying on their regular work sometimes may envy those in defense service, while the latter long for the days when they can return to their usual work.

It is often assumed that only a few sciences are directly involved in national defense. As a matter of fact, there is probably no broad field of science which is not making important contributions. Consider mathematics, the field of the first of the fifteen sections under which the work of the association is organized. Even if one knew precisely what is being done in each field at present, it would be improper to make it public. But there was no such limitation on the contribu-



DR. GORDON T. WHYBURN
PROFESSOR OF MATHEMATICS, UNIVERSITY OF VIRGINIA, CHARLOTTESVILLE; CHAIRMAN OF THE SECTION ON MATHEMATICS.



DR. RICHARD C. TOLMAN
PROFESSOR OF PHYSICAL CHEMISTRY AND MATHEMATICAL PHYSICS, CALIFORNIA INSTITUTE OF TECHNOLOGY; CHAIRMAN, SECTION ON PHYSICS.



DR. EDWARD A. DOISY
 PROFESSOR OF BIOCHEMISTRY, SCHOOL OF MEDICINE,
 ST. LOUIS UNIVERSITY; CHAIRMAN OF THE
 SECTION ON CHEMISTRY



DR. EDWIN P. HUBBLE
 ASTRONOMER AT THE MOUNT WILSON OBSERVATORY,
 CARNEGIE INSTITUTION; CHAIRMAN OF THE
 SECTION ON ASTRONOMY.

tions of science during the first world war. In that war mathematicians proved that the methods which had been developed for following the motions of planets were highly advantageous in calculating the flights of projectiles and bombs.

As to physics there is no question, for more than half the physicists in the United States are devoting at least part of their time on work for the Government, and the situation is nearly the same for the chemists. But it is natural



DR. MORRIS M. LEIGHTON
 CHIEF, ILLINOIS STATE GEOLOGICAL SURVEY DIVISION;
 CHAIRMAN OF THE SECTION ON GEOLOGY
 AND GEOGRAPHY.

to assume that astronomy can have no practical applications, except in navigation, in time of war. Yet during the first world war it made a very interesting and important contribution. As is illustrated on page 94 of this journal, the stars can be photographed through telescopes. This fact led directly in this country to a solution of the very difficult problem, then presented for the first time, of finding the height at which anti-

aircraft projectiles explode when fired under specified conditions and armed with fuses with given time settings. The problem was solved by photographing at night through two telescopes some hundreds of yards apart the explosions of projectiles against the background of stars whose positions with respect to one another are fixed and precisely known. From the apparent positions of the projectile explosions among the stars and the precise times of explosion (for the stars apparently move with the rotation



DR. J. T. PATTERSON

PROFESSOR OF ZOOLOGY AND DIRECTOR OF ZOOLOGICAL RESEARCH, UNIVERSITY OF TEXAS; CHAIRMAN, SECTION ON ZOOLOGICAL SCIENCES.

of the earth), the heights of the explosions were readily computed.

Let us not, however, permit our perspective to be distorted by the exigencies of the hour. Many addresses by distinguished scientists will be delivered at Dallas and many important symposia will be presented. Among the addresses those of the vice-presidents of the association, whose portraits are reproduced here, will be outstanding. There is a



DR. GILBERT M. SMITH

PROFESSOR OF BOTANY, SCHOOL OF BIOLOGICAL SCIENCES, STANFORD UNIVERSITY; CHAIRMAN OF THE SECTION ON BOTANICAL SCIENCES.



DR. GEORGE C. VAILLANT

DIRECTOR OF THE UNIVERSITY MUSEUM, UNIVERSITY OF PENNSYLVANIA; CHAIRMAN OF THE SECTION ON ANTHROPOLOGY.



DR. EDMUND S. CONKLIN
 PROFESSOR AND HEAD OF THE DEPARTMENT OF
 PSYCHOLOGY, INDIANA UNIVERSITY; CHAIRMAN
 OF THE SECTION ON PSYCHOLOGY.

vice-president of the association for each of the fifteen sections. Each vice-president is the chairman of his section and delivers a vice-presidential address, usually at the conclusion of his term of office, on some aspect of the subject of his section. These addresses are published in *Science* and constitute a valuable record of the progress of science. The presidents of many of the affiliated societies also deliver addresses which are usually published in *Science*.

As illustrations of the addresses of retiring vice-presidents, the following will suffice: Dr. George Scatchard, retiring vice-president for the Section on Chemistry, will deliver an address on "The Application of Chemistry to Biological Problems." Dr. J. T. Patterson, vice-president for the Section on Zoological Sciences, will deliver an address on "Drosophila and Speciation." Dr. W. Duncan Strong, retiring vice-president for the Section on Anthropology, will



DR. JOSEPH MAYER
 HEAD, CONSUMER INCOME AND DEMAND UNIT,
 OFFICE OF PRICE ADMINISTRATION; CHAIRMAN FOR
 HISTORICAL AND PHILOLOGICAL SCIENCES.



DR. E. W. GOODPASTURE
 PROFESSOR OF PATHOLOGY, VANDERBILT UNIVER-
 SITY SCHOOL OF MEDICINE; CHAIRMAN OF THE
 SECTION ON MEDICAL SCIENCES.

deliver an address on "Recent Archeological Research in Latin America." The addresses of the retiring vice-presidents for the sections on psychology and education will be delivered at a joint session of the two sections. Dr. Karl M. Dallenbach, vice-president of the former section, will speak on "The Temperature Senses: Their History and Present Status"; the subject of Dr. E. J. Ashbaugh, vice-president for the latter section, is "Education as Science and Art."

From the very nature of its organization the American Association for the Advancement of Science is an integrating agency in science; and because of the breadth of its interests, its large membership (more than 23,000) and the number of its affiliated and associated societies (now 182), it is the most effective agency for the purpose in the world. It achieves its ends in various ways: it is the bringing together of scientists from many fields—thirty-nine independent societies in Dallas in addition to the



DR. HAROLD F. CLARK
PROFESSOR OF EDUCATION, TEACHERS COLLEGE,
COLUMBIA UNIVERSITY; CHAIRMAN OF THE SECTION ON EDUCATION.



DR. R. L. SACKETT
EMERITUS DEAN OF ENGINEERING, PENNSYLVANIA
STATE COLLEGE; ACTING CHAIRMAN OF THE SECTION ON ENGINEERING.



DR. RICHARD BRADFIELD
PROFESSOR AND HEAD OF THE DEPARTMENT OF
AGRONOMY, CORNELL UNIVERSITY; CHAIRMAN OF
THE SECTION ON AGRICULTURE.

sections of the association; it holds general sessions at which the president of the association and other distinguished scholars deliver addresses of broad general interest; it provides opportunities for the organization of joint symposia by groups who have important interests in common—twenty-five such symposia at the Dallas meeting; and it publishes the most important symposia. It is difficult to measure the importance of such con-

tributions to science, especially in times of stress, but it is certain that they are forces of the kind that have revolutionized the world. Marching armies have their triumphs and their defeats, largely on the physical plane, but ideas are lodged and grow and mature in the unconquerable and irresistible depths of the mind.

F. R. MOULTON,
Permanent Secretary

THE MEMORIAL TO MARCONI

A SMALL triangular park, looking down the meridian of Washington toward the Executive Mansion, is being converted to an American national memorial to a man who by birth—and by burial—belonged to another nation, but whose achievements in the field of science and contributions to the progress of the human race made him a citizen of the world.

In granite and bronze, the memory and accomplishments of Guglielmo Marconi, inventor of wireless telegraphy—

the medium of communication which reduced time to an instant, encompassed all space and surmounted the barriers of mountain and sea—will be forever enshrined. In this dark period of the world's history, it is encouraging to note that a nation befogged by rumors of war and reports of destruction finds pause to pay tribute to one who dedicated his labors to advance the standards of civilization.

The Marconi Memorial will take the form of a double pedestal of Stony Creek granite, arising from a base of the same material. The lower of the two pedestals will support a bronze bust of the inventor. Behind this pedestal and bust will arise a broader and taller pedestal surmounted by the bronze figure of a woman carried on a half globe suspended in clouds, through which ethereal waves are passing. The sculptor, Attilio Piccirilli, has interpreted the work in the following words:

Against the shaft of the monument, on a base of classic simplicity, rests the bust of Marconi, as firmly planted as his fame. The head, modeled in its virile strength, stresses purposefulness in the line of the mouth, and vision in the far-seeing eyes under the great brow.

Symbolic of Marconi's contribution to science, the Wave speeding through ether covers the earth. There is the fleetness of lightning in the backward sweep of hair and drapery. There is direction in the outthrust arm guided by the noble head which, as the figureheads of the ships dominated the sea, now commands the heavens. With Promethean gesture the uplifted hand reaches for still greater gifts to man.

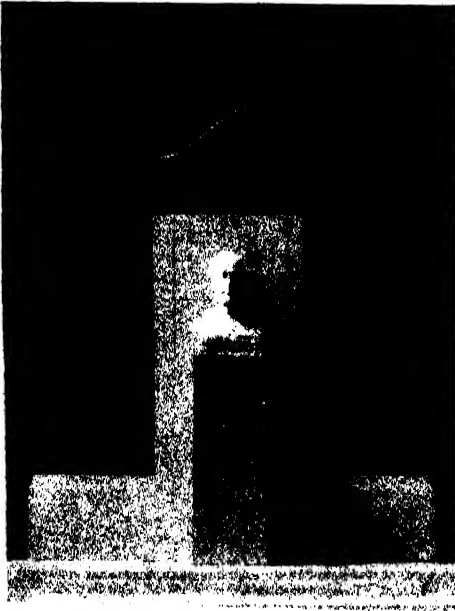

THE NEW MEMORIAL TO MARCONI

The memorial will be imposing in its grace and dignity and the beauty of its setting, rather than in its size. The pedestal holding the bust of the inventor will be only seven feet high and the bust three feet eight inches. The taller pedestal will be 13 feet 5 inches high, with the symbolic figure rising nine feet above.

The small park which provides the site for the memorial is located on the west side of 16th Street at Lamont Street, N. W., in Washington. The monument will be placed close to the north border of the park and will face the south. It will be approached by a curved walk leading from the south point of the triangle, along the west hypotenuse and crossing in front of the memorial, where it will form a paved plaza, exiting toward 16th Street on the east. Benches will be spaced along the walk to face toward the memorial. They will be shaded by American elms and backed by small hedges of evergreen barberry. Across the walk and bordering the lawn area, a low hedge of evergreen privet will lead toward the monument. Flowering dogwood trees will line the hedge at studied intervals.

The memorial will be flanked on either side by low-spreading yews and Washington thorns. Firethorns, dwarf yews and small-leaf holly will provide a low hedge behind the memorial. Japanese spurge will be used as ground cover. The entire composition will be enframed by flowering dogwoods. The landscaping treatment has been designed to take advantage of the four existing mature American elms which form a fine canopy along Lamont Street behind the memorial, and the existing silver maples which guard the 16th Street boundary.

The sculptor, Attilio Piccirilli, was born in Massa-Carrara, Italy, in 1866. He studied at the *Accademia San Luca* in Rome before coming to the United States in 1889. Among his better-known works are the *Maine Memorial* in Central Park, New York; the *MacDonough Me-*

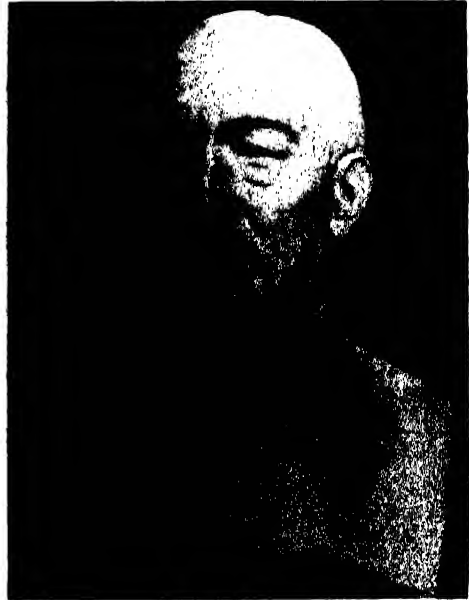

BUST OF MARCONI IN THE MEMORIAL

monial in New Orleans and the *Fireman's Memorial* on Riverside Drive, New York. He is represented in the *Fine Arts Academy*, Buffalo, by *Dancing Faun* and *Head of Boy*. His other works include *Apgar Memorial*; *A Soul*; *Flower of the Alps*; *Portrait of an Artist*; *Mater Consolatrix*; *Pediment*, *Frick House*; *Mater Amoris* and the *Pariah* of the *Church of St. Marks-in-the-Bouverie*, New York.

The architect for the memorial is Joseph H. Freeland, New York. Joseph C. Gardner, of Bethesda, Maryland, is the landscape architect. The memorial is being erected under authority of Congress by the *Marconi Memorial Foundation* of New York. Officers of the foundation are Generoso Pope, president; S. Samuel Di Falco, secretary-treasurer; John J. Freschi, Armerindo Portfolio and Ruigi Criscuolo, vice-presidents.

The man whose inventive achievements the memorial will commemorate was born in Bologna, Italy, on April 25, 1874, of an Italian father and an Irish

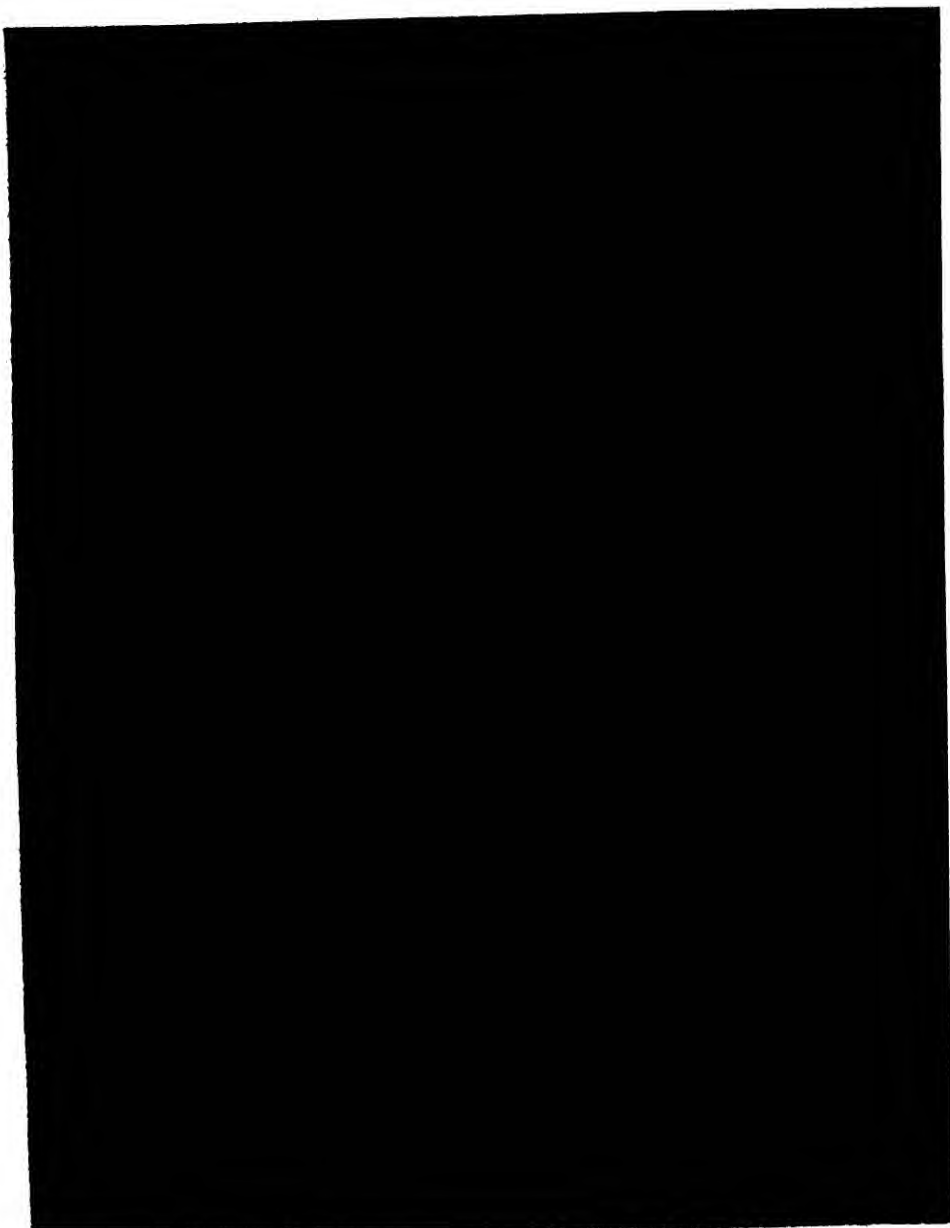

STAR CLOUD IN MILKY WAY

A FEW OF THE THOUSANDS OF MILLIONS OF STARS IN OUR OWN STELLAR SYSTEM. MILLIONS OF SIMILAR STELLAR SYSTEMS ARE KNOWN WHICH ARE SO DISTANT THAT MILLIONS OF YEARS ARE REQUIRED FOR THEIR LIGHT TO COME TO US.

mother. During and after his education at Bologna, Florence and Leghorn, he was interested in physical and electrical science. In 1895, when he was 21, he became convinced that a system of telegraphy through space could be provided by means of electromagnetic waves, the existence of which had been foreseen mathematically by Clerk Maxwell in 1864.

After experimenting at his father's estate in Bologna, young Marconi went to England, where on June 2, 1896, he took out the first patent ever granted for wireless telegraphy based on the use of electric waves. That same year he dem-

onstrated his invention to government officials, and in March, 1898, he sent a message across the English channel from England to France. Naval and military uses of his invention followed, and on December 12, 1901, Marconi, on his first attempt, succeeded in transmitting and receiving signals across the Atlantic from Poldhu in Cornwall, England, to St. John's, Newfoundland.

Marconi was awarded the Nobel Prize for physics in 1909, the Albert Medal of the Royal Society of Arts, and, in the United States, the Franklin and the John Fritz Medals.

EDWARD KELLY

THE EVENING SKY

Not often is the evening sky more beautifully sprinkled with planets and stars than during these winter months. As soon as the sun sets, and it now sets early, the most casual observer is almost startled by the white brilliance of Venus in the western sky. Toward the south red Mars stands out conspicuously from the stars, while in the east Jupiter rises and shines only second to Venus, and above Jupiter and a little to the right is ringed Saturn. These bodies are not stars but planets that, like the earth, revolve around the sun. The stars, other suns, are not lacking, for in the south-

east is Sirius, the most brilliant star in the sky, and above it are Rigel and the glorious stars that make up the Belt and the Sword of Orion.

Although the planet Venus is apparently much brighter than any red star in the sky, it is actually much smaller than any of them and appears luminous only because it reflects some of the light it receives from the sun. It is a little world, somewhat smaller than the earth and somewhat nearer the sun. Its year is about 225 of the earth's days in length, but the length of its day is uncertain because it is surrounded by a cloud-filled

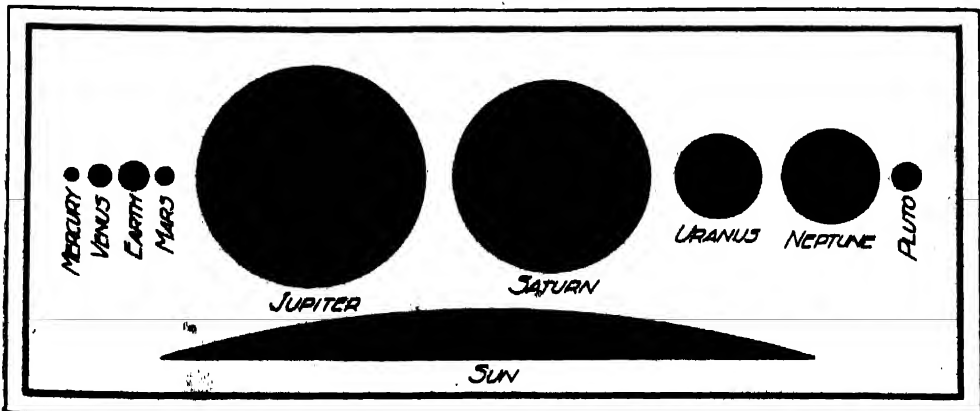

THE SUN AND PLANETS TO THE SAME RELATIVE SCALE



THE RINGED PLANET SATURN

A SILVEY OBJECT A SHORT DISTANCE NORTHEAST OF MARS IN THE SOUTHERN SKY; 75,000 MILES IN DIAMETER WITH AN AVERAGE DENSITY LESS THAN THAT OF WATER. THIS PHOTOGRAPH WAS TAKEN AT THE LOWELL OBSERVATORY IN 1912 THROUGH A YELLOW COLOR FILTER.

atmosphere that always hides its surface. It is its relative nearness to the sun and its highly reflective atmosphere that make it so bright as seen from the earth. Since it revolves around the sun in an

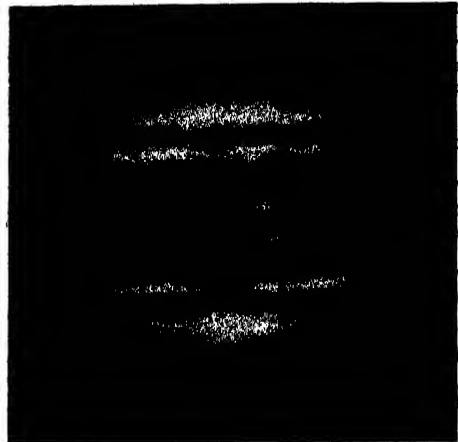

THE GIANT PLANET JUPITER

NOW VISIBLE IN THE EAST IN THE EVENING; A TENUOUS MASS OF GAS 88,000 MILES IN DIAMETER, MAKING IT LARGER THAN ALL THE OTHER PLANETS PUT TOGETHER. IT IS FIFTH IN ORDER OF DISTANCE FROM THE SUN. THE PHOTOGRAPH WAS TAKEN AT THE LOWELL OBSERVATORY.

orbit that is interior to that of the earth, its distance from the earth varies greatly. When it is between the earth and the sun it is invisible because its dark side is toward the earth. When it is on the opposite side of the sun it is invisible because it is lost in the sun's brilliant rays. Now, as we see it, it is east of the sun, following the setting sun down to the western horizon, and when observed through a telescope appears as a crescent with its convex side toward the sun. It will be at its brightest on December 28 when it can readily be seen, if one knows just where to look for it, before the sun has set and even at noon. But it is rapidly moving between the earth and the sun, to reappear in a few months on the other side as an equally conspicuous object in the eastern sky before the sun rises. It will not be a brilliant object in the evening again until the summer of 1943.

Jupiter, now in the eastern sky, is more than a thousand times as great in volume as the earth or Venus. It is less brilliant than Venus, both because it is



THE RED PLANET MARS

NOW VISIBLE IN THE SOUTHERN SKY EARLY IN THE EVENING; A WORLD HALF THE DIAMETER OF THE EARTH, HAVING A DAY ABOUT THE SAME LENGTH AND A YEAR NEARLY TWICE AS LONG. THE PHOTOGRAPH, SHOWING DARK EQUATORIAL BELTS AND WHITE POLAR CAPS, WAS TAKEN AT THE YERKES OBSERVATORY WITH THE GREAT 40-INCH TELESCOPE.

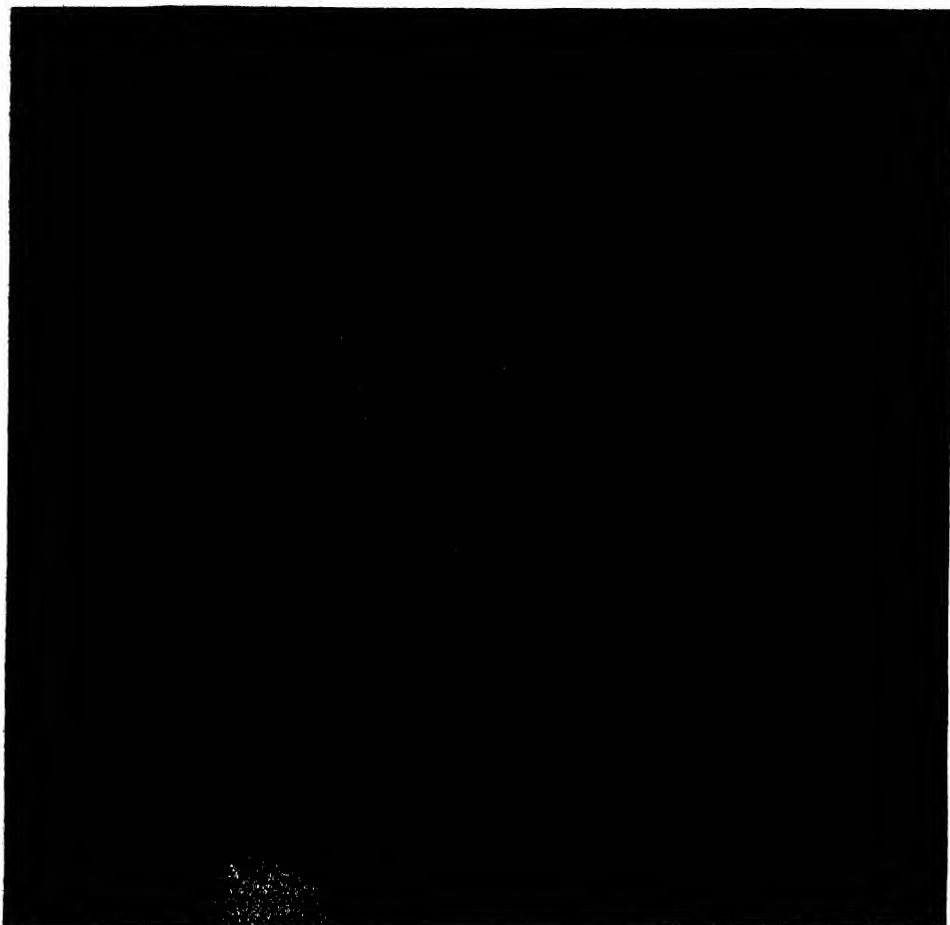

THE GREAT ORION NEBULA

A MASS OF GLOWING GAS, WHOSE DIAMETER IS 40,000,000 TIMES THE DISTANCE FROM THE EARTH TO THE SUN AND WHOSE DISTANCE IS SIXTY TIMES ITS DIAMETER.

farther from the sun, and consequently less intensely lighted, and because it is five times as far from the earth. Saturn is another large planet, though not quite so large as Jupiter, but noted for its enormous ring system and its nine moons, one of which revolves around it in the direction opposite to its rotation.

Of all the planets, Mars is the one that has been of greatest popular interest because of the markings that can be seen on its surface and of the speculations about its being the abode of life, possibly

of a high order of development. The diameter of this world is only a little more than half that of the earth, its day is a little more than 24 hours in length, and its year is nearly two of our years. Its atmosphere is as tenuous as that on the earth's loftiest mountain peaks and no oceans are spread over its surface. If there is life on Mars, especially higher forms, it must be quite unlike the life on the earth, for the environment of this life would be different in many important respects. To reproduce itself and

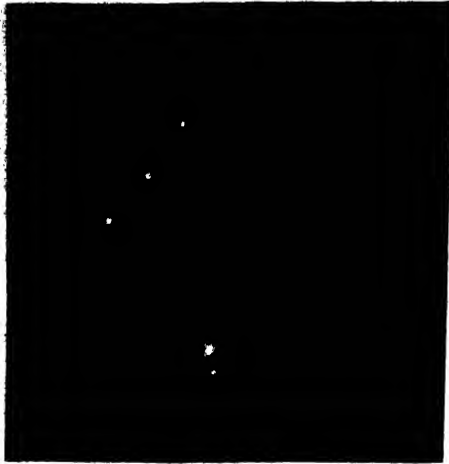

BELT AND SWORD OF ORION

NOW VISIBLE IN EARLY EVENING IN SOUTHEASTERN SKY. THE THREE DIAGONAL BRIGHT STARS FORM THE BELT; THE THREE VERTICAL STARS BELOW FORM THE SWORD; THE CENTRAL ONE IS SHOWN IN LARGER SCALE IN THE PRECEDING PICTURE. ALL THESE STARS ARE SO DISTANT THAT THE LIGHT WITH WHICH THIS PHOTOGRAPH WAS TAKEN LEFT THEM SEVERAL HUNDRED YEARS BEFORE PHOTOGRAPHY WAS INVENTED.

endure, it evidently would have to be adapted to the conditions surrounding it.

In a troubled world, the planets shining in the evening sky at the Christmas season this year arouse in us wonderment and vague yearnings that Sir Alfred Noyes, in his "Watchers of the Sky," personified in the planets themselves, the Earth saying:

Was it a dream that, in those bright dominions,
Are other worlds that sing, with lives like mine,
Lives that with beating hearts and broken
pinions

Aspire and fall, half-mortal and half-divine?
A grain of dust among those glittering legions—
Am I, I only, touched with joy and tears?
O, silver sisters, from your azure regions,
Breathe, once again, your music of the
spheres:—

"A grain of dust among those glittering legions"! Those glittering legions to which Sir Alfred refers are the sparkling stars that are brightest and most numerous in the winter and early spring months. Instead of being "silver sisters" of the earth, small bodies revolving around our sun or some other sun, they are suns themselves, almost always a million times as large as the earth and Venus and even Jupiter. Like our sun, these enormously hot bodies radiate light and heat at an inconceivably rapid rate. They appear to be mere points of light because of their enormous distances. Even Sirius, the nearest star visible from northern latitudes, is so distant that the light from it which reaches our eyes when we now look at the southeastern sky in the evening has been on its way more than four years. The light of most of the stars we see has been speeding for hundreds of years through the immensities of space before it encounters this "grain of dust among those glittering legions."

F. R. M.

THE SCIENTIFIC MONTHLY

FEBRUARY, 1942

ARTISTIC DEVIATION AS AN ESTHETIC PRINCIPLE IN MUSIC

By Dr. CARL E. SEASHORE

RESEARCH PROFESSOR OF PSYCHOLOGY, UNIVERSITY OF IOWA

THE purpose of this article is to indicate some of the approaches to the scientific investigation of an art principle in musical esthetics.

DESIGN

Esthetics in the past has dealt primarily with the composer's design, the musical form, which comes to us in the conventional score. But this score has a number of limitations. First, while it indicates pitch and time in definite notation, it has no significant dynamic notation for individual notes; and while the quality of the tone is set in part by the harmony and the choice of instrument, the score has practically no note-to-note nomenclature for the quality of tone the composer desires from voice or instrument. In other words, the composer has only fragmentary means of indicating to the performer what he himself would do or would require. The score is certainly a very inadequate blueprint for the artist's performance. Yet the design which is cast in musical form is the basic contribution to the embodiment of beauty in music.

Second, true pitch and exact time or rhythm as indicated with precision in the score would make very poor music if followed mechanically. No good singer or instrumental soloist stays on true pitch as indicated by the score, even for a fraction of a second, and only in

the sense of having a basic temporal reference does he perform in metronomic time. Regarding loudness, or volume, and timbre, or tonal quality, the performer has almost complete freedom as the score says little or nothing about them. The reason for this musical license is that beauty in the rendition of a composer's design lies most frequently in the artistic play with deviations from the regular—true pitch, even loudness, metronomic time or pure tone, or any of their combinations or derivatives. Here is a basic esthetic principle. This may sound like heresy because one sanction of plain honesty in musical circles is to the effect that the performer must not garble the work of the composer; and, in training circles, we are rightly led to believe that true intonation in pitch and precision in temporal values as written are among the first skills that should be acquired. We may accept these as good training principles because the performer must be able to intone in true pitch and metronomic time with precision, before he can master the skills of artistic deviation from them.

Third, it is due to the recognition of the principle of artistic deviation that artists find unlimited opportunities for variation and interpretation, for the expression of their creative power and artistic sensitivity, and for differentiating their individuality as artists. While



FIG. 1. DRINK TO ME ONLY WITH THINE EYES, AS SUNG BY ARTHUR KRAFT. The dots mark off tenths of a second; the vertical bars, seconds. The horizontal lines separate semi-tones; the wavy line indicates the form of the attack and the release, the periodic pulsations, and progressive rise or fall in pitch. The lower curve shows the rise and progressive changes in intensity in terms of decibels. The musical notation is interpolated. From Seashore, H. G. An objective analysis of artistic singing, *Univ. Ia. Stud. Psychol. Mus.*, IV, 1937.

we assign first place in esthetic value to the composer's score, we are led to see that the artist must himself become a creator, or at any rate a molder, of the beautiful forms but crudely indicated in the score. Thus, while there is a definite area and responsibility for the student of esthetics in evaluating the score as a contribution of the composer, it is the artist's rendition which the scientist records and analyzes and which, in common language, is the music on which the listener bases esthetic judgment.

THE PERFORMANCE SCORE

The experimenter in musical esthetics now parallels the conventional musical

notation with performance scores showing exactly how the artist rendered the design set out by the composer. This differs from the conventional notation in that it shows exactly how the artist used his musical media in creating the art object, the physical music. Instead of indicating a single note, such as a quarter-note, to specify pitch and time, it presents a graph showing the form of attack and release and the periodic and progressive changes in pitch: in short, all deviations from true pitch, whether artistic or erratic. It shows how the given quarter-note was modified in duration for the purpose of rhythmic phrasing or as a result of lack of skill. It likewise represents quantitatively in fine detail how this one note fluctuated in intensity. The three factors, pitch, time and intensity, are usually indicated in a single score, as in Fig. 1.

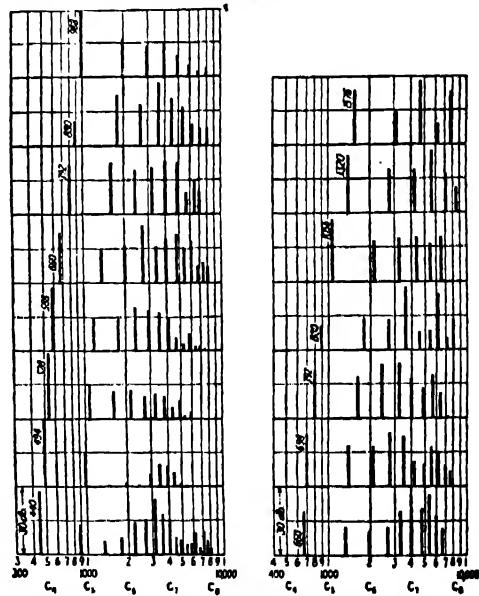

FIG. 2. VIOLIN ARPEGGIOS ON THE A-STRING, LEFT, AND THE E-STRING, RIGHT, AS PLAYED BY SMALL.

Vertical bars show the relative intensity of each partial in terms of decibels. Pitch is indicated at the bottom in terms of frequencies. Figures in italics indicate the fundamental pitch of each spectrum. From Small, A. The violin in the laboratory, *Proc. Mus. Teach. Nat. Assoc.*, 1938.

In view of the fact that tonal quality is in a constant flux in a tone, performance scores are presented in the form of simple cross sections of a given note, or series of notes, as fair samples in terms of a tonal spectrum, showing the harmonic structure of the clang, as in Fig. 2. Such a tonal spectrum is the basis for the hearing of timbre in a simultaneous fusion of the fundamental with its overtones. By showing the sequence of tonal spectra throughout the duration of the tone, we get a performance score in terms of sonance, as shown in Fig. 3. Thus we get a complete and objective description of the quality of tone as a whole.

Through such performance scores, we take the basic problems of esthetics from the ill-defined, intangible and airy regions of speculation, doubt and mysticism and reduce them to verifiable formulae on the basis of measurement. The invention of this simplified score is like the invention of a language; it enables us to transmit symbolically the result of countless observations and measurements in comparatively simple but scientifically indispensable graphs. These graphs may take a variety of forms depending upon the instruments used, the data in hand and the purposes to be served. The piano, for example, requires a special piano camera and a particular type of performance score, the principle of which is illustrated in Fig. 4.

For each of the basic aspects of music, we now have units of measurement and zero points of reference. Tonal modulations are measured in terms of the number of vibrations of deviation from the pitch of the note as indicated in the score; dynamic modulations are measured in terms of decibel deviation from the threshold of audibility or a standard reference tone; temporal modulations are measured as deviations from metronomic time in hundredths of a second;

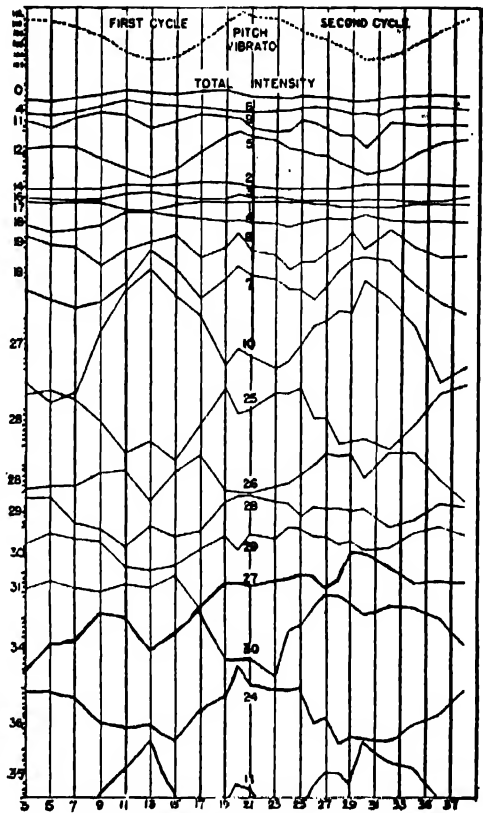

FIG. 3. THE INTERNAL STRUCTURE OF A BEAUTIFUL TONE AS SUNG BY BORCHERS, SHOWING SONANCE IN TERMS OF SPECTRA FOR ALTERNATE SOUND WAVES FOR A PERIOD OF ONE THIRD OF A SECOND.

Each vertical line represents a tonal spectrum for the line as indicated at the bottom. The intensity of each partial is represented by a horizontal graph numbered at the center. Numbers at the left indicate intensity levels in terms of the number of decibels below the total intensity, 0. Pitch is indicated by the small numbers at the left top. There are two cycles of pitch vibrato in this one third of a second as indicated in the top curve. It is assumed that each overtone has the same pitch vibrato as the fundamental. The timbre vibrato is revealed by the intensity pulsations of the partials, notably numbers 5, 10, 25, 30, 24. The even total intensity is the result of compensation in the partials. Observe that there are five partials that are stronger than the fundamental, the first partial. From the author's article on Sonance, *Mus. Ed. J.*, Oct., 1936.



FIG. 4. THE FIRST FOUR MEASURES OF THE LAST MOVEMENT IN BEETHOVEN'S SONATA, OPUS 27, NO. 2, AS PLAYED BY CLAPP.

Each note is represented by a bar in the conventional cleff, showing the moment of incidence, the duration and the release of the note. The vertical bars mark off tenths of a second. The intensity is shown for each note by a number on the scale of 1 to 9 from the softest to the loudest (the intensity could be indicated on a decibel scale as in Fig. 1). Horizontal lines between the cleffs show the pedal action: solid line for full pedal; dotted line for "half" pedal; and break in the line for absence of pedal. The four measures are numbered. For description of camera and full performance score, see *Univ. Ia. Stud. Psychol. Mus.*, IV, 1937.

and qualitative modulations are measured in terms of redistribution of energy in the partials, the zero point of reference being the pure tone.

The idea I wish to convey is that acoustical science with its cameras has now intercepted the sound wave, which is the only and universal medium of music, and enables us to measure, analyze and present vast masses of facts in a simple and musically significant language. Thus if we want to know what artistic devices Lily Pons employs in singing, Menuhin in violin playing, or Hofmann in his piano interpretations, we may now invite them into the laboratory studio, where they will perform under the same conditions as for radio, and complete and permanent phono-

graphic and photographic records will be available after a single performance. For many purposes the now available high fidelity phonographic recordings may also be used as research material, providing adequate precautions are taken in relation to the possible distortions. The phonographic record of the performance score will be the source material on which the future esthetician will work in discovering and verifying esthetic principles which operate in actual music.

THE PRINCIPLE OF DEVIATION AS A MEDIUM OF MUSICAL ARTISTRY

The point of view heretofore presented is, of course, not new to leaders in the musical profession, but there is frequently a ten-

dency to underestimate or becloud the role that artistic deviation plays in music. Some critics proclaim that the types of detail shown in the performance score for actual musical artists are of little significance musically. We can trace several survivals of mystic tendencies and traditions in musical circles underlying this criticism in the absence of scientific information.

One criticism is that the musical performance is more than the physical sound. This "more" takes several forms depending upon the culture level of the musician, which makes it difficult for him to realize that everything that is conveyed from the performer to the listener, as music, is conveyed on sound waves in terms of which the performance score is built. He has some sort of mystic feeling that his own emotions, ideas of beauty, subjective interpretation or theories of musical values can be conveyed by some mysterious form of musical telepathy. When pressed for illustration he points vaguely to suggestion, gesture, association of ideas, smiles and frowns, environmental atmosphere and the supersensory reality of music. These may profoundly modify the perception, appreciation and interpretation of the physical tone, but they are not the music: the musical composition as actually rendered in physical tones is the only musical medium that can bridge the gap between the performer and the listener.

A more objective attitude is that of the musician who looks at the performance score and says that these minute deviations in pitch, loudness, duration and tonal quality are smaller than the ordinary errors of musical observation; the listener does not hear them. To this the experimenter replies that although they may not be heard individually, their mass and variety of forms combine to give character to the music which we do hear and judge, just as in a painting, a

fragment of red or blue may not be noticed by the observer, but the total accumulation of color pigments in pigments and their infinite variety, blending and shading is what gives beauty in color to the picture.

A third objection comes from those who say that most of these deviations are simply errors in performance. That is, of course, largely true for many incompetents who ply the art, and it is also true of even the best artists in that their capacity for achievement is relative and that in many respects they assume a considerable region of tolerance for precision.

But in dealing with competent artists it is easy enough to find abundant material in the way of deviations which have esthetic value, even though they may not be heard individually as such. Frequently the performer himself is not aware of them because they function as well-established habits. Furthermore, the objective study of the performance score reveals the operation of a great variety of esthetic principles which spring directly out of the emotional demands without the performer's being aware of them as such. These are usually more numerous than the known or voluntarily followed principles.

This defense of the principle of artistic deviation from the beautiful is, of course, set up in contrast with the well-established esthetic principle assigning beauty to certain types of fidelity to the score. My contention is that the basic esthetic sanctions, such as unity and balance, harmony and richness, contrast and symmetry, are far more frequently obtained by principles of deviation than by principles of fidelity and uniformity.

PHRASING

With these preliminaries, we may now turn for illustration to some well-recognized principles of esthetics which can be quantified and systematized by the

experimental procedures here indicated. The most general term applying to principles of artistic deviation in practical music is that of phrasing. This is a very comprehensive term covering a vast array of esthetic principles, both subjective and objective, in musical artistry.

Fig. 5 shows how a violinist indulges in freedom from regularity. If he had not so indulged, the lines for pitch, in-

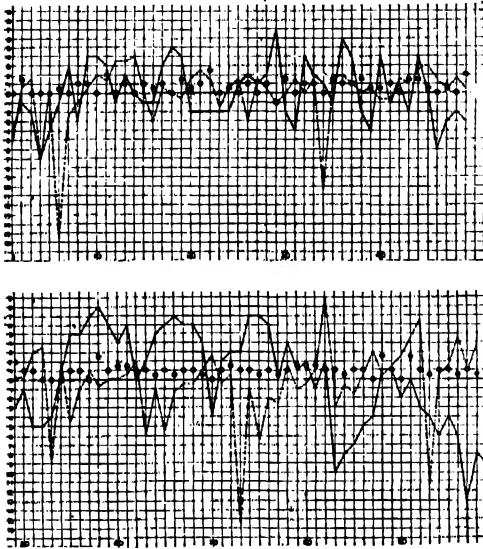

FIG. 5. SECTION OF PHRASING SCORE FOR PITCH, INTENSITY AND TIMBRE FOR THE AVE MARIA (SCHUBERT-WILHELMJ) AS PLAYED BY SLATKIN.

There is one point in the graph for each note as numbered at the bottom. Successive notes are shown on the abscissa. For pitch, units on the ordinate represent .1 tone; and the 0 point indicates exact intonation in the tempered scale. The circles mark the mean-pitch level of successive notes. For intensity, units on the ordinate represent 1 decibel and the 0 point indicates the average of the mean intensities of the notes. The solid line indicates the mean intensity for successive notes. For duration, units on the ordinate represent .1 seconds and the 0 point indicates exact distribution of time throughout a measure in accordance with the score. The dotted line indicates temporal over-holding (+), or under-holding (-) of successive notes. From Small, A. An objective analysis of artistic violin performance, *Univ. Ia. Stud. Psychol. Mus.*, IV, 1937.

tensity and time would have tended to be straight and would have indicated that the rendition was cold, unemotional and devoid of artistic interpretation. The student of musical esthetics must ask hundreds of questions in relation to a single passage like this. Assuming that the artist is competent so that the constellation of variations is significant, the student of esthetics must ask for every cross section of the score: Why did he augment or diminish the interval to this degree at this point? Why did he increase or decrease the loudness in this direction and to this degree at this point? Why did he take liberties with the metronomic time by lengthening or shortening, by anticipating or by over-holding the note at this point? And if we had the timbre score in terms of the spectrum at each stage in the phrase, he would ask similar questions about it, and more of them.

The significance of this deviation is well illustrated when we attempt to compare two performers. For example, if we ask two equally competent professional pianists to perform a given beautiful selection at their best before the camera, the performance scores will reveal a remarkable similarity in their interpretative treatments of note, measure and phrase, although no mention was made of phrasing or the purpose of the recording. This indicates that there is a common stock of principles which competent artists tend to observe; that the character of each measure or phrase tends to make the same emotional appeal to both; and that they unquestionably find similar outlets for the expression of their individuality in the esthetic interpretation. We should not, of course, assume that there is only one way of phrasing a given selection, but even with such freedom, two artists will reveal many common principles of artistic deviation. Furthermore, in so far as there are consistent differences in their

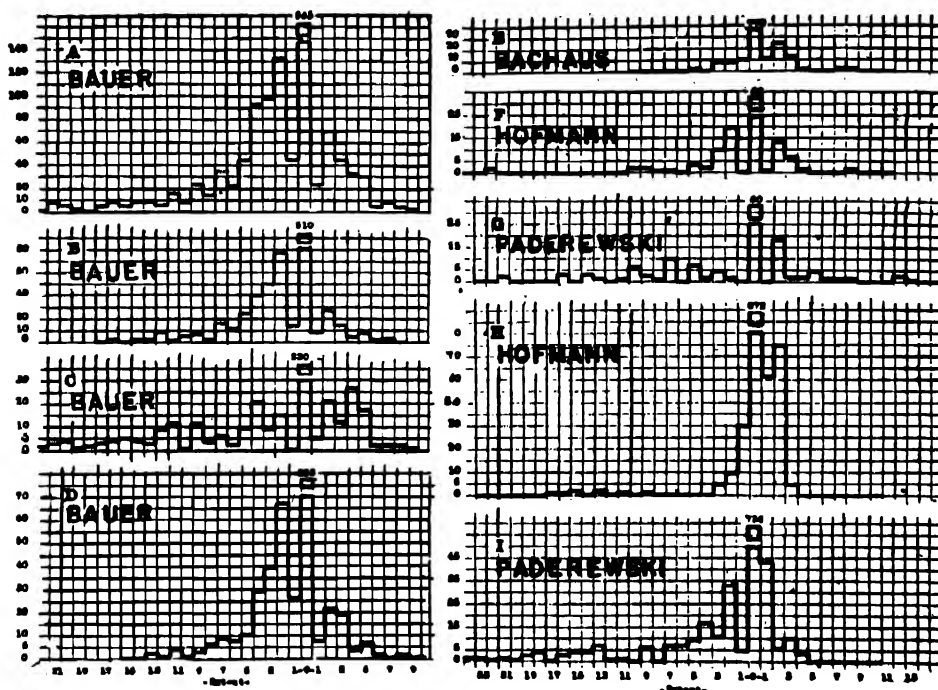

FIG. 6. EXAMPLES OF TYPICAL ASYNCHRONIZATION BY DIFFERENT PIANISTS IN TERMS OF FREQUENCY AND EXTENT OF ASYNCHRONIZATION.

Scale at the bottom .01 second; at the side, number of cases. From Vernon, L. N. Synchronization of chords in artistic piano music, *Univ. Ia. Stud. Psychol. Mus.*, IV, 1937.

phrasing, these differences may reveal elements of musical individuality.

Then again if we ask one artist to play the same selection several times in succession with no other instructions than to play as beautifully as he can, he will tend to indulge in the same artistic deviations in successive playings, provided he does not definitely aim to give different interpretations.

The asynchronization of chords by the advancing or delaying one hand as against the other or the leading note in one hand is one of the common devices for artistic effect in phrasing. This is shown in Fig. 4, by the slanting dotted lines. It has been shown that there are a number of varieties of principles of asynchronization which cooperate to the same effect; that significant asynchronization may occur as frequently as in half of the chords; that each type of music

makes the characteristic demand for this device; and that each player may reveal his individuality in the use of this device both by the frequency and the extent of the deviation. Some comparisons of artists in this respect are given in Fig. 6.

One specific element in phrasing pertains to principles of diminishing or augmenting intervals in relation to accepted scales. Musical esthetics in the past has concerned itself with the interval, and to-day the fastidious violinist prides himself in his individuality and his skill in interval refinements, such as the augmenting or diminishing of an interval in various degrees for specific purposes. There are a number of rules which he recognizes, but ultimately his intonation is guided by a sort of moving feeling of fitness for each individual intonation. When we make objective measurements of the performance of the best recognized

violinists, we see that they all show certain common tendencies as to the direction, movement and extent of deviations from standard intervals; that none plays consistently in either the tempered scale or the natural scale; but that on the other hand there is a marked tendency toward the Pythagorean scale as shown by the condensed averages in Fig. 7.

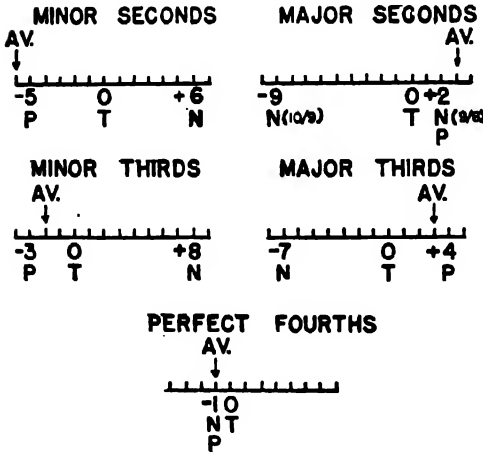

FIG. 7. THE AUGMENTING OR DIMINISHING OF INTERVALS BY VIOLINISTS.

The tempered scale is taken as a point of reference and marked 0. Plus indicates augmenting, minus, diminishing, of the interval. The scale is in terms of hundredths of a whole tone step. The theoretical position in this figure is marked by T for tempered, N for natural or just intonation, and P for Pythagorean. The average performance of six leading violinists is indicated by the arrow. From Greene, P. C. Violin performance with reference to tempered, natural and Pythagorean intonation, *Univ. Ia. Stud. Psychol. Mus.*, IV, 1937.

Let me but mention one more of the hundreds of varieties of esthetic principles that may be revealed systematically by a phrasing score; namely, the substitution of time for stress or stress for time which, in itself, becomes a complicated structure of theory and practice. From the early classical times to the present this has been a moot issue in poetry. But in music the issue becomes more evident and presents itself as a fascinating

field for objective studies that may settle disputes which have raged for hundreds of years. In the best music we find abundant examples of the absence of stress in the accented note of the measure when the rhythm of the measure is very clear. We must therefore turn in search of a substitute, such as time for stress.

Some of these principles were known to the performer and served as a goal in his performance. The score can, of course, be used in verifying, elaborating and systematizing these. Other principles expressed with equal regularity were not known to the performer but are the result of the unanalyzed feeling of satisfaction in a particular deviation. We must, of course, always assume that there is a certain range of mere errors, but these can often be teased out by comparative studies.

Thus the phrasing score becomes a tool with which we can describe the artist's interpretation of a given measure, phrase or passage in terms of esthetic principles of deviation. In such terms we can set up esthetic goals for the acquisition of skills and emotional expressiveness. No one has yet made a complete analysis of a phrasing score or is likely to do so in the near future because it represents such an endless variety of artistic outlets; and yet we can at this stage take any esthetic principle recognized by a composer and trace it objectively in these scores, thus laying foundations for the classification of principles of artistic deviation, which is one element in the beauty or ugliness of music. We do not now know how many esthetic principles are involved, how they cooperate, interfere and integrate. But we do know that they are all expressed in terms of the possible variants in the sound wave: frequency, amplitude, duration and form. If we grant that the medium of music is physical sound, there is no escape from the principle that in terms of four variables of a sound wave

there is room for an infinite variety in artistic deviation and that it can be expressed quantitatively in a performance score.

These physical performance scores can be converted through the application of known laws of acoustics, physiology and psychology into what we may call hearing scores, showing what the listener actually hears, which is quite different from the performance score of the artist showing what he actually played or sang. This difference will, of course, vary with an endless variety of factors in the ability and application of the listener.

MUSICAL ORNAMENTS

As another general type of artistic deviation, let us turn to the field of musical ornaments. Of the thirty or forty recognized musical ornaments employed by artists but seldom indicated in the score, the vibrato is the most universal and musically significant type. It is one of the essentials of good musical quality and is present in the voice of every singer, young or old, trained or untrained, primitive or cultured, in long notes and short notes, in high notes, in low notes. Artists of instruments which allow fine modulation in pitch employ it deliberately; and even in some instruments, such as the woodwinds, it comes out automatically in good players.

Here we have a striking example of how a fundamental factor in performance consists entirely of artistic deviations from the regular. When we had taken this little understood, greatly abused and frequently misrepresented element into the musical laboratory we were able to list at one time more than two hundred musical questions about it which had been answered by exact measurement in the laboratory; such as, **What is the vibrato? How many kinds of vibrato are there? What are some significant norms? What are its characteristic uses on the stage to-day? How**

does it compare in voice and instrument? Are so-called tremolos anything but bad vibratos? What are some of the common elements of vibrato and the trill? What illusions of hearing make it tolerable? What is the average pulsation in the pitch vibrato? In the intensity vibrato? In the timbre vibrato? Why is the vibrato so often objectionable? What factors determine tolerance in rate? How can we refine the vibrato on the basis of experiment? It sounds a little like magic to assert that questions of this kind can be answered by the hundreds by taking adequate samples of performance into the laboratory and making exact measurements and analyses; but such measurements are now a matter of routine.

We may define a good vibrato as *a pulsation of pitch, usually accompanied by synchronous pulsations of loudness and timbre, of such extent and rate as to give a pleasing flexibility, tenderness and richness of tone*, and we may define a bad vibrato as *any periodic pulsation of pitch, loudness or timbre, which singly or in combination, fails to produce pleasing flexibility, tenderness and richness of tone*. These definitions imply that there are three species; namely, the pitch vibrato, the intensity vibrato and the timbre vibrato. And of each of these there is a wide array of varieties, each contributing in some specific way to the beauty of tone. There is an enormous leap from the bare recognition of the existence of the vibrato, or the denial of it in many a musician, to such complete exposure of its reality, its roles, its limitations, its objectively verifiable definition and description as they emerge from the laboratory.

The laboratory has two fundamental approaches. First, the natural history method by which a sufficient number of fair samples are collected from their true settings in beautiful music and then measured, analyzed and classified. The

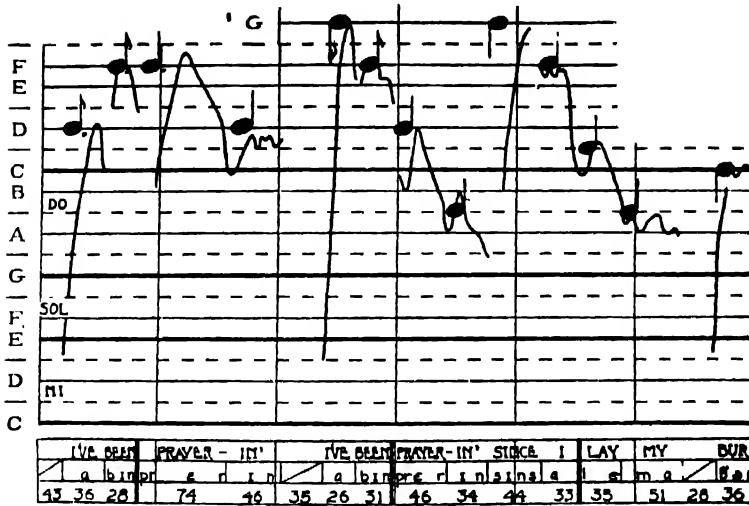

FIG. 8. PERFORMANCE SCORE OF AN UNTUTORED NEGRO SINGING A SPIRITUAL BEAUTIFULLY IN A CORN FIELD OF NORTH CAROLINA. For notation, see Fig. 1. From Metfessel, M. J. Phonophotography in Folk Music, Univ. North Carolina Press, 1928.

other is the method of physical science in which with the use of tone generators we can produce any desired form of vibrato experimentally to verify known esthetic principles and discover new ones.

One need hardly mention how a specific scientific knowledge of the vibrato increases the resourcefulness in the hearing of it. How different is the critical hearing of the vibrato in the actual musical situation by one who has been trained in the laboratory or the studio to hear its countless manifestations, from one who recognizes an undefined change in tonal quality!

MUSICAL LICENSE

Until recently musical anthropologists described primitive music, such as that of the Indians or the South Sea Islanders, in terms of our conventional scales, simply mentioning that certain types of freedom or "errors" were exhibited. But when phonophotography came in, the ridiculousness of that attempt was made manifest. Fig. 8 is an

illustration of a Negro singing a spiritual very beautifully. I have interpolated the musical notation which indicates what we tend to hear. But the performance score shows how far this is from reality. We listen to this untutored Negro's beautiful singing in terms of our habitually established interval scales. It would be foolhardy to say that this song was not good because he did not have true intonation in terms of our musical intervals. Thinking only in terms of pitch, we might say there is an esthetic principle, which we might call the principle of soaring, with complete pitch license, like the eagle winging its way in graceful sweep. It is interesting to observe how this Negro superimposed a pitch vibrato upon the actual pitch line in the performance score instead of upon the intonation of a true note in the scale. This principle of soaring, then, instead of being regarded as a departure from true music, represents a principle of beauty in itself, a form of artistic license, the eating of forbidden fruit, the spontaneous expression of feeling.

This principle of soaring is, of course, present in infinite variety, such as that of attack and portamento and other forms of glides, in ornaments and in gradual transitions from speech to musical intonations.

NATURE OF THE ESTHETIC IN MUSIC

In the above I have shown how the scientist takes the actual music of the composer and performer and dissects it in the laboratory for the purpose of description, classification and explanation of the phenomena involved. We have found reason to demand that a fundamental requirement of the artist is the ability to intone in true pitch and metronomic time. True pitch, metronomic time, pure tone and even intensity represent fundamental esthetic values. But while beautiful in themselves, they represent mainly points of reference for orientation from which artistic deviation constitutes the main groundwork of musical artistry.

At this stage we may well inquire what the phenomena here discussed have to do with esthetics. Many good musicians have not read any books on esthetics. Academically the subject is usually taught as a branch of philosophy just as was the subject of psychology half a century ago. But as psychology has now been taken into the laboratory and has been recognized in the sisterhood of sciences, so many problems of esthetics are now taken into the

laboratory, and wherever possible, scientific experiment is substituted for artistic speculation.

There is still room for a number of distinctive and legitimate approaches to the subject. The philosopher analyzes the concept of musical values, the theory of knowing esthetic values and the nature of beauty in relation to ultimate reality. Sometimes he is in danger of imposing a mystic or esoteric conception of the nature of the beautiful. The musical historian and critic traces the evolution of musical concepts of beauty in terms of the progressive enrichment of musical composition and musical performance by the adoption of new media. The anthropologist traces in a similar way the evolution of the progressive development of music in races and nations. The artist formulates esthetic rules of performance and embodies these in artistic skills. The educator aims to increase the power of the appreciation of music and the development of musical skills in the light of available knowledge.

All these approaches nibble at the question: What is beautiful in music and how can we know it? One seeks universal principles, another seeks practical rules, another traces the evolution of this human power of exhibiting the beautiful, another aims to enlarge our knowledge and deepen our appreciation of it; and the latest comer, the scientist, comes in and offers to describe, criticize, verify and explain wherever scientific procedure is possible.

THE EVOLUTION OF WAR

By ARTHUR STANLEY RIGGS

WASHINGTON, D. C.

WARFARE, instead of being the mark of an inferior and uncultured type of man, has from its inception been the product—on the aggressor's part—of the most advanced civilization. Necessarily, then, we must somewhat recast our ideas of it, of the evolution which swung it forward from clumsy mass murder and rapine without interest or any redeeming feature to its present form, horribly multiplied at times, but rendered intensely interesting as a social study because of its psychology, strategy and tactics.

Before we go any further we must agree upon a definition of what we are considering. To be both clear and convincing, that definition must include a great deal more than the shock of armies or fleets meeting in action.

"War," said General Baron von Clausewitz, one of the world's greatest military analysts and historians, is "only a continuation of State policy by other means . . . none of the principal plans which are required for a war can be made without an insight into the political relations." And again: ". . . war is not merely a political act, but also a real political instrument, a continuation of political commerce, a carrying out of the same by other means . . . for the political view is the object, war is the means, and the means must always include the object in our conception. . . . State policy is the womb in which war is developed."

To this we may add the statement by General Sir J. F. C. Fuller, D.S.O., formerly of the British Imperial General Staff: "Though . . . the establishment of a more contented, prosperous and secure state of peacefulness is the true

grand strategical object of a war, it by no means follows that this has been generally accepted; in fact, few wars have led to so desirable a conclusion."

It should be obvious from these two statements that war was a phase of life unknown to primitive man. Eolithic man, and his successors for thousands of years, had nothing worth fighting for, material or otherwise. Not until his club and hand-stone had developed from crude domestic tools into offensive weapons, and he possessed women and other animals capable of bringing him increase, did he become a property owner, thus exciting the envy of his fellows. With the passage of a few more thousand years he became civilized enough to abandon nomadic life, to herd with his fellows in large groups, and eventually to build towns.

By this time he possessed considerable rudimentary culture. He had the beginnings of agriculture, of architecture, of pottery; he had probably even learned to use fire and to make clothes of some sort. His substantial mud-brick or stone and wood hut was something to be proud of. His possessive instinct waxed strong and bold. He looked around, saw that other towns had better houses, larger herds or flocks, perhaps more desirable women. Envy bred cupidity; cupidity easily transformed itself into mass raiding. Danger spiced the enterprise, and the loot satisfied his savage longings.

This, however, was no more true war than are the violent predations of gangsters in our modern cities. It was the beginning of the everlasting struggle between the "Haves" and the "Have-Nots." It was marauding only; it went

on as marauding for no one knows how many millennia; it goes on to-day among still primitive tribes.

With the increase of both wealth and culture, time eventually produced strong tribal and community leaders, the loose grouping of early society gave place to a more orderly civilization, and we have the beginning of kings. These petty monarchs, if judged by our standards, were probably the biggest and strongest thugs in their respective groups. They had to be physical masters to hold control. As power feeds upon itself and grows accordingly, it was not long—archeologically speaking—before these little kings precipitated a substantial body of folklore, developed a cult of royalty, formulated genuine government and even created something in the nature of royal policy.

War began somewhere in the dim past when one of these early kings decided that it was not good for his town and region to have a potentially inimical city-

kingdom only a day's march or so away. To persuade his councilors, and then the rabble, of the necessity of wiping out their neighbors was easy. Just where that first war started no one knows. The minor kingdoms of ancient times left little to record their valor. So it is not until we reach Egypt in point of time that we find the martial phase of politics not only well developed but recorded in astonishing detail.

Before 4000 B.C. Egypt was fighting as a matter of state policy, by orderly means, against raids and encroachments of jealous enemies. For the first time we see war conducted on the basis of its three indispensables: movement, supply, destruction. For the first time, also, we find during the fifteenth century B.C. a definite understanding on the part of an Egyptian general of both strategy and tactics. Strategy, not to be too technical, might be loosely defined as the art of war; tactics as the scientific application of that art.

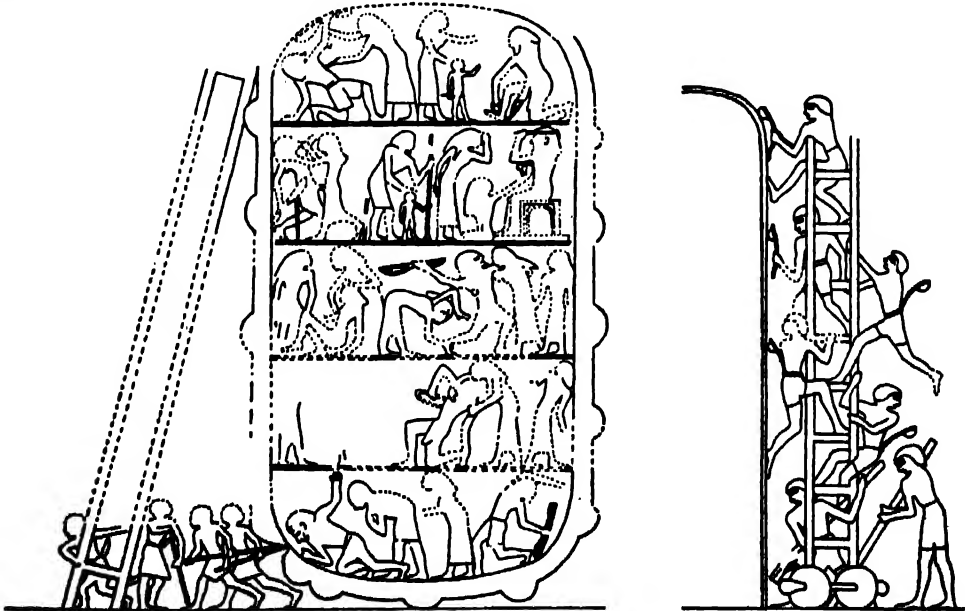

WALL-PAINTING OF ANCIENTS ATTACKING A FORTRESS

FORTRESS REPRESENTED BY GROUND PLAN SHOWING BUTTRESSED WALL INSIDE OF WHICH A CONFLICT IS PICTURED IN FIVE REGISTERS. EGYPTIAN WOMEN ARE SHOWN DEFENDING THEMSELVES AGAINST FOREIGN INVADERS. FROM A LADDER ON WHEELS BESIEGERS TRY TO BREAK DOWN WALLS.

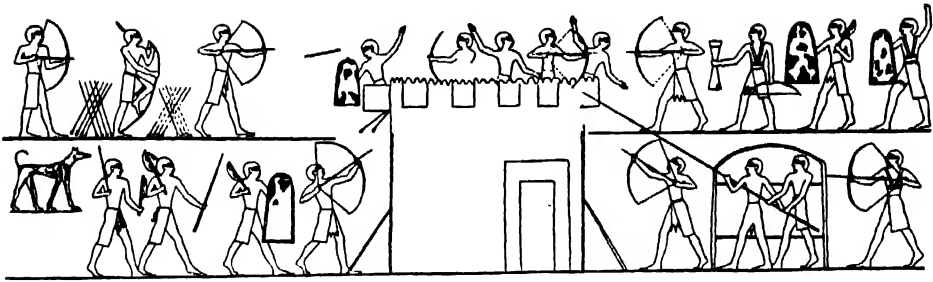

SOLDIERS ATTACKING A FORTRESS

FROM A WALL-PAINTING IN THE TOMB OF AMENEMHAT AT BENI HASAN, ABOUT 1940 B.C. THE ATTACKING PARTY WITH BATTLE-AXES, SOME OF THEM PROTECTED BY SHIELDS OF DAPPLED BULL-LOCK'S HIDE, MAKES AN APPROACH TO THE FORTRESS GATE UNDER COVER OF THE ARROWS OF THEIR ARCHERS, WHILE MISSILES ARE HURLED DOWN ON THEM FROM THE BATTLEMENTS. IN THE UPPER ROW, AT LEFT, AN ARCHER IS STRINGING HIS BOW BY PRESSING HIS KNEE AGAINST INNER SIDE; IN THE LOWER ROW, AT RIGHT TWO MEN SHELTERED BY A TESTUDO TRY TO SPEAR DEFENDERS ON THE WALL WITH A LONG PIKE.

At this relatively recent period war had not developed. It was a matter largely of frontal mass shock and a free-for-all mêlée without regard for the waste involved. The labored dullness of the military type of mind which was responsible for this has continued unchanged from prehistory to the present. Basically it works in exactly the same way as the mind of the primitive who had only clubs and stones as weapons. Consider, for example, the ruthless feeding of Italian peasants who do not want to fight into the direct fire of Greek guns in Albania; or go back to the last World War and remember the way Crown Prince Wilhelm forced his men into the horrors of Verdun, until almost six hundred thousand of them rotted about the French fortifications.

By the time the Feudal Age had reached its perfection, the Egyptians had learned to link warlike purposes with economic advantage. About 2000 B.C. they did one of the most remarkable things ancient history records. They dug the first Suez canal. It connected the northwestern horn of the Red Sea with the eastern branch of the Nile. Freight and passenger boats could thus come from Punt (the present Somali Coast) with their precious loads to

Egyptian distributing points. Commerce leaped forward—and Egyptian war galleys could by means of this short cut transport armies and supplies to strategic points without delay or difficulty. The link went even farther, for the products of distant Crete and perhaps even Sicily became available to the dwellers along the Red Sea and Indian Ocean, while the redoubtable Egyptian Navy began to make its power felt throughout the Mediterranean.

By 1580 B.C., when Ahmose I came to the throne, he found an Egypt with a first-class professional army also, having expert archers as the dreaded mainstay and fire power of its offense. These highly skilled infantrymen had learned how to fire by volley with such effect that they established a reputation which made them feared a thousand years. Moreover, besides their bows, they carried spears for short-range work and battle-axes for hand-to-hand combat. As a tactical unit, a battalion of these archer-spearmen compares perfectly with a battalion of modern infantry equipped with rifle and machine-gun for long range, hand-grenades for close, and the bayonet for hand-to-hand work.

It was under the generalship of that old lion, King Thutmose III, in 1479 B.C.,

that Egypt demonstrated to the world that she had—at least in the person of the king—the essentials of strategy. On the morning of the 15th of May he had disposed his army in such a manner as to prevent the flight of the King of Kadesh, trapped with his army before the city of Megiddo. Satisfied that all roads to the north were effectively blocked, Thutmose got into his glittering chariot of electrum and led a roaring charge against the enemy. They broke at the shock of the galloping horses and heavy chariots, fleeing in every direction. The fight became a rout, and everything was abandoned on the field. The strategic plan of battle was perfect. Tactically there was nothing left to be desired. But the plans failed because Thutmose had not realized that his soldiers would forget all about duty in their frenzied looting. In the confusion the King of Kadesh got away and the job had to be done all over.

Thutmose's strategy, however, does not imply that military campaigns took such subtleties into account generally in the world of that day. Human thinking had not yet advanced to the point at which such a thing was possible. Politically Egypt was both shrewd and unscrupulous, and the detailed story of her foreign

policy reads like a twentieth century European chronicle of the growth of population, the gradual raising of internal pressures, the ambitions of the king's political advisers, the forcing of external commerce followed by the necessary establishment of colonies to foster and maintain it, then the dispatch of troops to protect the colonies, the familiar frontier incidents, the cry of the greedy for more room and more power and war.

At this point we note a vital difference between the raids of preceding times and the organized warfare of the Egyptians. The former was total, and left the defeated country stripped bare of all useful life as well as of everything worth stealing. Egyptian conquest cost the defeated dearly, but no Egyptian general or king ever stained his record with unnecessary slaughter, slavery or theft. When Megiddo fell, besides all the booty of the actual battlefield, the city had to pay tribute, of course, but there was no such brigandage as the Germans to-day are exercising in Norway and Holland. Slaves were taken in war, of course, and many of them were horribly abused in the mines far to the south; but the general policy of exacting penalties only drastic enough to make the conquered people behave tied in with the advanced



MILITARY ESCORT OF A KING IN THE EMPIRE

FROM WALL-PAINTINGS IN THE TOMBS OF MERYRA AND AHMES AT TELL AMARNA, DATED ABOUT 1375-1358 B.C. (1) EGYPTIAN SPEARMAN ARMED WITH SPEAR AND SQUARE-HEADED BATTLE-AXE, WITH A SHIELD FOR DEFENSE, (2) THREE FOREIGN SOLDIERS REPRESENTATIVE OF MERCENARIES IN THE ARMY: LIBYAN WITH BATTLE-AXE, SEMITIC SPEARMAN AND NEGRO BOWMAN, (3) TRUMPETER.

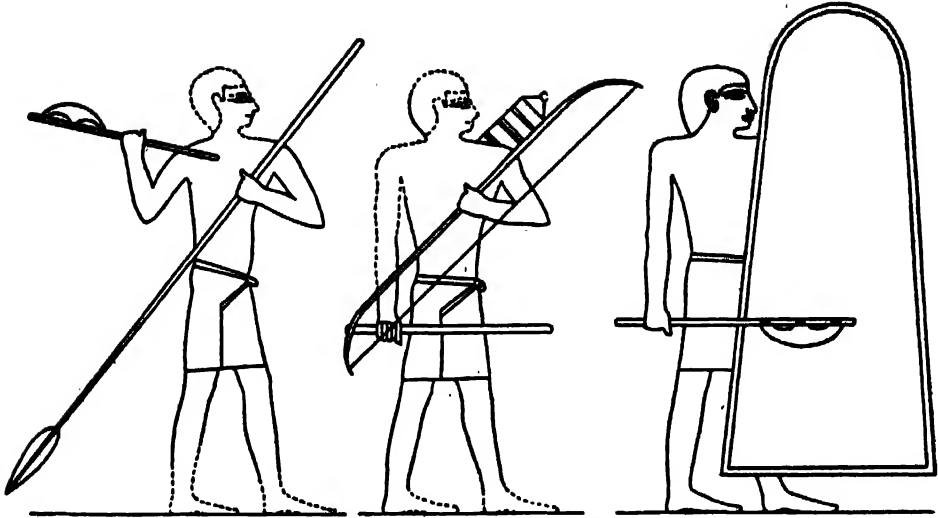

ARMED ATTENDANTS TO A NOMARCH OF THE MIDDLE KINGDOM
 FROM WALL-PAINTINGS IN THE TOMB OF TEHUTHIOTEP AT EL BERSHEH, DATED ABOUT 2000-1788
 B.C. SERVANTS ARMED (1) WITH SPEAR AND BATTLE-AXE, (2) WITH BOW, QUIVER AND SHORT
 STAFF, (3) WITH BATTLE-AXE AND GREAT SHIELD.

levels of art, science and religion which characterized the Nile dwellers.

The point already made, that strategy was not widely understood, was also characteristic. The king might on rare occasions prove a strategist, as Thutmose III did. But usually he was a mere theorist, a politician, an egoist and, if he happened to be personally courageous, reckless in his impetuosity. He was also severely handicapped by having too many generals who were politicians and ambitious for their own advancement, but who knew little of the real art of war. Because of the experience gained in the long struggle to expel the Hyksos usurper dynasty, tactics had made a considerable advance, and we have besides the much feared archer in the infantry, the precursor of cavalry, the chariot corps. In action, the chariots charged with a fearful yell while the archers fired a blinding volley over their heads and charged at the double for close work after the horses and vehicles had broken the enemy line.

Up to this time the horse had not yet

begun to figure as the vital element in shock tactics. If the enemy line happened to be many files deep, the chariot charge would itself founder in the first few ranks, and the army reform to meet the oncoming archer-spearmen undismayed. It was all very much on the order of a first-class riot.

During these early times naval power was little understood, was correspondingly not used in any strategic manner, bore little relation to or coordination with the armies, and so failed to accomplish what it otherwise might have done. The Egyptians, again, were the only seafarers who made statesmanlike use of their fleets. The Minoans of Crete had gone as far west as Sicily, and perhaps conquered it in a raid; but they quickly passed and left nothing permanent. The Egyptians, some hundreds of years later, captured one Mediterranean island after another, followed up their naval conquests by colonization and military occupation, and had some glimmerings of the true purpose and effectiveness of sea power, though naval strategy was still

undreamed of and far in the future. This universal misconception and neglect of sea power accounts for the fact that national policies until within the most recent times have been based almost wholly upon military power alone. To-day we realize that wars are primarily economic in their generation, and that to be successfully prosecuted there must be a fusion of all interests and arms. But that is so modern a conception it was not fully grasped even during the first World War and is not understood to-day by a majority of the people anywhere.

In marked contrast to the humane behavior of the Egyptians at war was the Assyrian method. Here was a fierce mountain folk, weaned upon the blood of its enemies, making a national policy not only of unprovoked wars of conquest, but using the most revolting cruelties in prosecuting them. That the Assyrians knew something of the use of fear as a psychological weapon to demoralize the enemy before the shock of battle came is well established. This was strategy of a sort; but in the field the Assyrians evolved no startlingly new conceptions. Like the Egyptians, they relied, at least in the early stages of their development, upon their archers. Later they developed true cavalry battalions, which gave

them vastly greater speed and mobility than any of their rivals. The unimpeded horse could outpace the chariot at its best, and was particularly useful in mountain work where the heavy vehicle could not go at all.

Not even the most careful apologist for this astonishing race can escape from the categorical records they left behind in shameless approval of their conduct. Cut off from access to the sea and its trade by the Mitanni and the Phoenicians to the northwest and by the Egyptians to the southwest, the Assyrians, like the Germans of to-day, developed from a small group of no importance to a flourishing nation which, during its great empire period, between about 750 and 612 B.C., carried on trade widely, conducted ruthless total warfare, developed an astonishing civilization peculiar to itself, and lived merely to die in the field. Before its day of splendor ended, it had conquered and wiped out ancient Babylon, captured and ruled Egypt with savage harshness, extended its sway far up beyond its own borders into the mountains, turned Palestine into a mere tributary, and burned the stamp of its terror into the souls of every nation even remotely bordering it. The taint of the wild beast was in Assyrian blood.

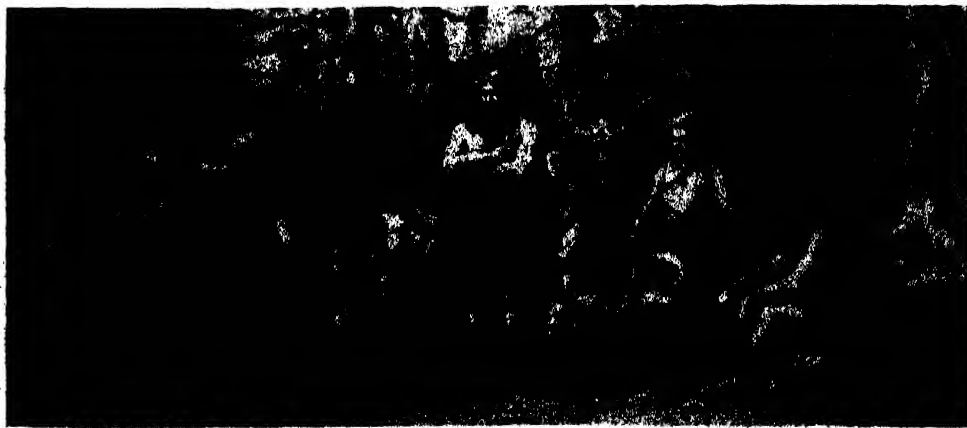

Courtesy American Museum of Natural History
MURAL OF NEOLITHIC MAN IN THE CAMPIGNIAN STAGE OF DEVELOPMENT
 NOTE CONICAL HUT, COOKING POT AND DOMESTICATED DOGS. PAINTING BY CHARLES R. KNIGHT.

Byron knew it when he sang that "The Assyrian came down like the wolf on the fold." Wherever he went he left annihilation or smoking desolation behind. Upon the gates of what had been prosperous cities were nailed the hides of prisoners of importance, skinned alive and flung to the dogs, while the horrified populace stared with incredulous eyes at the bloody work the snarling curs finished. About the gateways, to add terror, tall stakes driven into the earth supported the writhen corpses of kings and generals, impaled shrieking as an object lesson. Total war was resuscitated, made more ghastly. The modern German is merely an imitator of his classic predecessor. Frightfulness was the code the Hun took over from the Assyrian.

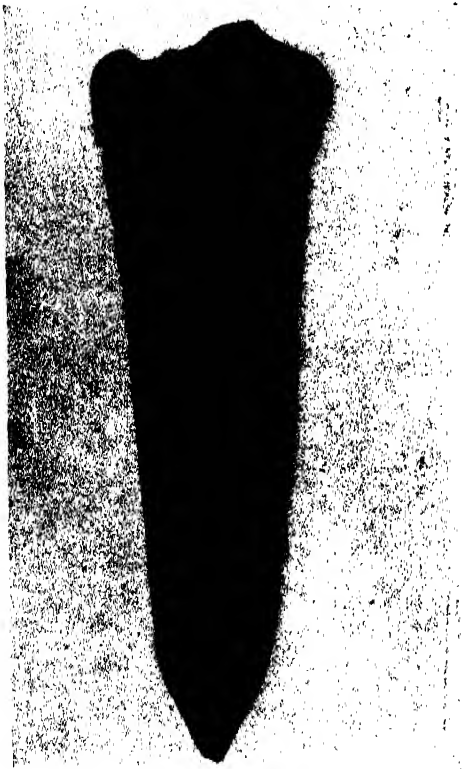

IRON DAGGER BLADE
WITH ENGRAVED DESIGNS. FROM THE LASITHI
PLAIN, GREECE. ABOUT 1800-1600 B.C.

The analogy between Assyrian and German may be carried still farther. While the Assyrian system of calculated savagery was reducing country after country and rapidly extending the Assyrian boundaries, the empire was paying a price so terrible that the greater the successes achieved, the deadlier were the germs of doom loosed upon the country. Conquest meant fighting, and even the redoubtable Assyrian army had to sustain a good deal of blood-letting. Frantic enemies fought for their lives and killed so many Assyrians that eventually the army consisted to a large degree of foreign levies and slaves. Centuries before it had been necessary to conscript the peasantry from its fields for only short periods. The losses had not been insupportable. But steady campaigning and the growth of the army to meet the needs of the occasion, hold the new borders and go on to further conquests, finally all but wiped out the peasants. Great and small farms lay fallow because there was no one to cultivate them. The food supply dwindled; famine threatened; not all the supplies from the outside made good the deficiency. Rich profiteers bought up the desolate farmlands and created showy country estates. But these produced nothing of value. Forced labor was not sufficient to supply the army, and the rest of the population fared ill indeed. Hunger, worry and fear stalked the land.

Then the blight extended from the home territory into the conquered lands. The Assyrian monarchs, though they introduced the cotton tree and made a feeble effort to create a new industry, failed completely to see that their national policy was as destructive as their system of warfare. Revolts sprang up everywhere. The subject countries—one thinks inevitably of Austria and Czechoslovakia—were full of sedition and bitterness, their levies in the army could not be trusted in hard fighting, and on every hand those enemies not yet stifled

threatened the rapidly weakening empire. Assyria at last had *Lebensraum*—room to live—so much room that its armies could not support themselves or defend their boundaries. In 612 B.C. the once invincible Assyrian army went down, after the Persians' two-year siege of Nineveh, into such a total defeat that the city was laid flat, the people annihilated, their language wiped out of human memory. Nineveh was nothing more than a vague tradition, and a series of astonishing clay-tablet records which shamelessly boast of the Führers of the period and the severity of their military methods. Total war had found its reward in its own extinction.

Two things are evident thus far. First, war as a national enterprise conducted under orderly methods is clearly the extension of economic and political necessities, or what were considered necessities. That was what distinguished war from marauding. Second, we see war still as a matter of frontal attack and the effects produced by shock. The occasional strategy of a genius like Thutmose III makes the contrast the more glaring. Since Assyrian times war had not developed at all in frightfulness and relatively little in methods. History has repeated itself again and again until we find the growth of numbers so enormously swollen by 1914–18 that weight paralyzed mobility, and war settled down to trench murder.

Between these two periods, however, strategy and tactics revealed themselves startlingly from time to time in unanticipated ways. The Assyrians had shown the world that cavalry was more mobile, swifter and more flexible than chariotry. It was the classic Greeks who, next after the Egyptians, resorted to strategy of the highest character when they built and successfully used the wooden horse. Homer sang immortally the triumph of both ruse and tactical device.

The Greeks, nevertheless, did not al-

ways distinguish themselves strategically. If we may credit the accounts we have of Greek battles and the hero tales of the Golden Age and earlier, we have to admit that war to the Greeks was a sort of super-badboy affair except where it concerned the repulsion of an invader. There the heroism and brilliance we have witnessed to-day in Albania had their vivid inception. Here and there, of course, some individual leader was thinker enough to introduce a new idea into war, turning the old roaring shock into something entirely different.

After the fall of Nineveh and the coming upon the scene of the Persians, there began a shrewd national policy which led later to the collision with Greece. Centuries before, the Egyptian canal at Suez had silted up and been forgotten. But Darius the Great in 521 B.C. looked far ahead with statesmanlike keenness and foresaw the time when Persia would need ships and sea fighters desperately to protect the conquests of which he dreamed in a very practical manner. So he explored the Indus River, the coast from its mouth to Suez, discovered and reconstructed the old canal, built a war fleet and sent it by this short cut far up into the Mediterranean Sea. After that he organized a powerful Phoenician auxiliary fleet, and Persia became the first great sea power of Asia. Before Darius died the Persian western frontier was the River Danube.

It was inevitable, therefore, that Persia should attempt to spread toward the south under Darius's son, Xerxes, and the head-on crash with little Greece became certain. Gathering the mightiest armada ever seen, Xerxes moved ponderously to the attack, the quarrelsome Greek city-states united for mutual safety under the leadership of Athens, and the first and mightiest shock came at Salamis in 480 B.C. To meet the combined Phoenician and Persian fleets Greece was able to gather only an in-



Courtesy of the Metropolitan Museum of Art
DETAIL OF SHEATH FOR SCYTHIAN SWORD, FIFTH TO FOURTH CENTURY B.C.
SHOWING A GREEK FIGHTING A PERSIAN.



SLAB FROM A WALL ALABASTER FROM SENNACHERIB'S PALACE, 705-680 B.C.
SHOWING KING SENNACHERIB'S CAVALRY IN THE MOUNTAINS.

ferior force, and Themistocles, the Athenian commander-in-chief, was afraid his allies would run away if the battle began to go against them. His strategy, therefore, was based primarily upon the fear of his own weakness, but it was none the less brilliant.

Instead of meeting the Persians in the open sea, Themistocles took his heterogeneous fleet into the bay on the island of Salamis, close to the mainland. This bay has two entrances, a small mouth to the west, a large one to the south. The moment Xerxes' admiral saw what the Athenian had done, he was convinced that the Greeks had made one of those fundamental blunders which can not be

was generally the left wing. Epaminondas scouted his enemy, saw that Cleombrotus, the Spartan king, had his best men twelve files deep in his right wing, and accordingly made his own left the heaviest shock body ever known to that time—fifty files deep, in phalanx, with the famous Sacred Band in front. Then, in furtherance of his idea, and to render the shock more paralyzing, he arranged his entire force *en échelon*, and moved obliquely to the assault, first instructing his center and right to delay attack until he had broken the Spartan front. Spartan courage has never been impugned, but the heaviest shock the Spartans had ever known was multiplied by the sur-



BRONZE SWORD MADE FOR KING OF ASSYRIA, XIV CENTURY B.C.

retrieved. Ordering his Phoenician allies to close the western entrance and cut off any Greek retreat, the overconfident Persian moved with his main body to attack through the large mouth. The Greeks were bottled up securely. They had to fight because they could not run away. Themistocles' strategy was justified by the disastrous defeat of the Persians.

A century later, in 371 B.C., another brilliant example of strategy illuminated the dreary chronicle of Greek civil warfare. At Leuctra, Thebes and Sparta met in desperate combat. Epaminondas, the Theban commander, like his Athenian predecessor, knew his troops were low in morale. Armies fought in an extended line, the best troops and bravest individuals, as well as the commander himself, holding the right. The weak spot

of the Thebans' new methods. King Cleombrotus fell at the first exchange. About him died most of his staff. The weight of the Theban phalanx crashed through and tore the Spartan line to tatters. Men had begun to learn.

Again strategy and tactics forged ahead when Alexander of Macedon reversed the usual idea of mass fighting and of the elements that made up armies. First he did away with the slightly trained citizen-soldier as the main striking power of all armies, replacing him with disciplined professional soldiers. Alexander also perceived that if a good soldier was effective, a good soldier mounted upon a good horse would be many times as effective in striking power; and since mass assault was still the keynote of battle, he kept his infantry to the rear, put his ablest men on

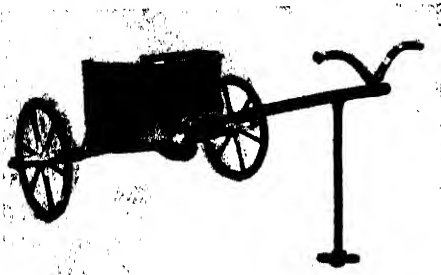

CHARIOT OF YUYA AND TJUYII,
XVIII EGYPTIAN DYNASTY.

horseback, and won every one of his great battles by thundering charges that no phalanx of the time could resist. He invented the new tactical unit of heavy cavalry, and put it to successful strategic use.

After the Greek examples of occasional spurts of progress, war slipped back again into its familiar rut of clumsy murder. The Romans reverted completely to type in adopting the legion as their standard of armed force. True, the legion, armed with short, heavy sword and short javelin, and professionalized to the last degree, conquered the world. But it was a bloody, smashing, brutal

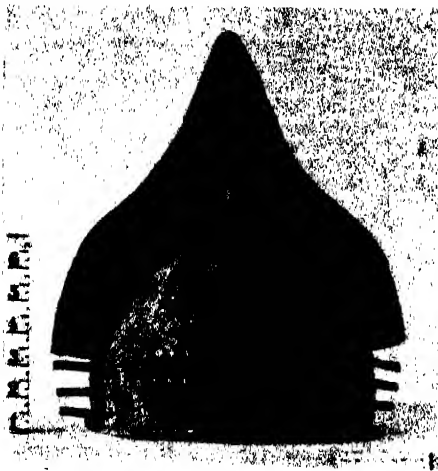

BRONZE HELMET
EARLY ITALIC, NOT LATER THAN XI CENTURY B.C.

affair for the most part. Very few of the Roman consuls and other leaders were soldiers. The Roman armies often suffered from being led by politicians; even at times from having three political leaders (consuls) simultaneously, each one exercising command a day at a time.

Politics were the ruling factor in Roman life when the greatest strategist the world had known appeared in Italy in 217 B.C. Not yet thirty years old, Hannibal of Carthage performed the incredible feat of marching his entire army, elephants and all, across the Alps in the dead of winter. Rome did little to stop him until he reached the relatively easy plateau of northern Italy. Fabius, the Roman general who awaited him in the plains, was a soldier and a good tactician. Before Hannibal's advance he dropped back steadily until he had reached the shores of Lake Thrasy-mene. Then, through political changes at Rome, he was recalled. Without his wise leadership the Romans had to trust to the senior consul, Flaminius, who blundered into a trap set by one of the keenest strategists of all time.

During the night Hannibal so placed his troops that a large part was hidden in the narrow gulches between Thrasy-mene and the Cortona mountains, his main body being camped on a rise in full view of the Romans. Failing to reconnoiter his road, Flaminius marched confidently into the gulch at dawn, not seeing the troops above and to either side of him, and charged down upon the Carthaginians massed in front. Silently the ambushade closed in behind him. What followed was sheer massacre: at least 15,000 Roman legionaries killed, thousands more wounded, and ten to twelve thousand stragglers driven in panic rout all over Etruria.

That first lesson should have been enough, yet it was only the beginning. As Hannibal marched southward, his army in higher spirits than ever, Rome

desperately scraped together an army of seventy thousand, many of them raw militia and citizens, forgot the viciousness of political appointments, and dispatched this horde under three quarrelsome consuls to meet the enemy. While the consuls bickered, Hannibal marched circles around them. When they should have been planning, they were squabbling; and Hannibal captured all their supplies and equipage. Finally, before the town of Cannae, they suddenly faced the main Carthaginian force and found themselves forced to fight. Hannibal had aligned his troops so that the wind blew from them into the faces of the Romans, who would have to fight in choking clouds of dust, or retreat to secure fresh supplies. Consul Varro, whose turn it was to command, did not consult his co-commanders, but signaled to join action.

Unfortunately for Rome, Varro was nothing more than a big business man. To pit himself against the Carthaginian fox was matching a pullet against a coyote. Varro's 55,000 legionaries were almost twice as strong as Hannibal's 32,000, but the Carthaginians were seasoned veterans. Varro had 6,000 cavalry against Hannibal's 10,000. But the chief difference between the armies lay in their commanders. Varro knew what would happen to his political future if he failed, so he followed the time-tried Roman copybook method, stolidly lining up his army in the conventional manner, with his heavy infantry in the center, the cavalry screening his wings.

It seemed to his inexperienced eye that Hannibal had done the same thing with his smaller force. Full of confidence, he made the fatal signal, not noticing that Hannibal had weakened his already thin center by taking out 12,000 soldiers and placing them in the rear in two solid columns. Out cantered the Roman cavalry to open the fight, only to break and retreat hastily as the better Cartha-

ginian horse charged to meet them. Paying no attention to this skirmishing, the stolid legions marched steadily ahead and met the Carthaginian infantry.

Instantly the African cavalry dropped its pursuit of the Romans, wheeled, formed into a solid group in the rear and attacked furiously. Now the discipline of the legions came into play. There was no panic. Rome struck back as steadily as though she were not fighting two



Courtesy National Archeological Museum, Athens
THE BUST OF LEONIDAS,
 HEROIC KING OF SPARTA, WHO FELL WITH HIS
 GALLANT THREE HUNDRED AT MARATHON. STANDS
 TO-DAY IN ATHENS MUSEUM.

actions at once, front and rear. Then the strategy that had passed unnoticed came into play with a fatal crash. The sides of Hannibal's trap were open. He slammed them shut by throwing his reserve infantry across, closing the Romans in on four sides.

All that bitter day the slaughter raged. Roman courage and determination struggled vainly against Carthaginian hatred and skill. When night fell

and the exhausted Carthaginians had nothing more to do, 40,000 Roman infantry and 2,700 cavalry lay dead upon the field, and the rest had fled in utter rout. Hannibal sent home with his message of victory a bushel basket of the gold rings of their rank worn by Roman knights who had perished.

The story could be carried on almost indefinitely until the Middle Ages, when the wars carried on by the mercenary soldiers in the pay of ambitious princes simulated the utmost fury, and developed a crude strategy peculiar to the local conditions. However, the *condottieri* were careful not to kill or mutilate too much. War was a matter of the employer who paid best, and in whose service the loot and kidnapping and rape were the most satisfactory. Moreover, with the passage of time and fresh inventiveness, war had passed into another stage of development, the age of protective armor. But tactical inventions for both offense and defense have kept close together all through the ages, and no sooner had the knight learned to sheathe himself in steel than the longbow and the crossbow developed a power that enabled the archer and the crossbowman to drive a "clothyard shaft" or a quarrel through the finest armor at fifty yards or more.

Another step in time reveals the first master strategist's attempt to coordinate sea power and land power. Napoleon had no peer as a leader of armies. So when he, like the present Germans, mobilized a huge army at the Channel ports and announced that he would invade England, the European world shivered. Carefully he brought together a great allied Franco-Spanish fleet, and told his admirals: "Give me command of the sea for three days, and England is mine." Trafalgar was the answer, and the dictator's project failed because his strategy and tactics were not the equal of the British.

With the introduction of gunpowder at the close of the Middle Ages, a third modifier entered the military field. The horse had given mobility and speed, armor bodily protection of a sort, and now powder enormously increased offensive power; to such a degree that neither protection nor speed availed against it. Thereafter the changes that occurred between Napoleon's day and our own were chiefly concerned with size and fire. Then overnight the airship came into being, totally changed the relations of the different arms, added an entirely new factor which had to be taken into the gravest consideration, and made all the old ideas of speed and striking force seem childish play. The first World War gave us the beginnings of air warfare: primitive, crude, almost as fatal to its exponents as to its opponents, but promising a development whose end is not by any means yet in sight. Hand in hand with air warfare came the armored tank, that lumbering, fire-breathing dragon whose initial foray so completely crushed the German troops against which it was used. Both strategy and tactics were profoundly modified by these new weapons. They were further modified by the adoption of poison gas.

World War manoeuvring, however, revealed very little strategical advance over that of previous wars. The tactical differences caused by the use of the new weapons on land and the submarine at sea were not especially significant. The vital thing was that possession of more powerful weapons, and a strategy that carefully prepared the ground long in advance of actual military operations, seemed to fill the aggressors with the Assyrian spirit of ruthlessness, gave them such a sense of fitness and superiority that they over-expanded, and finally trapped them by so increasing the weight of their men and equipment as to nullify mobility and create so onerous a burden upon the home population that the strain

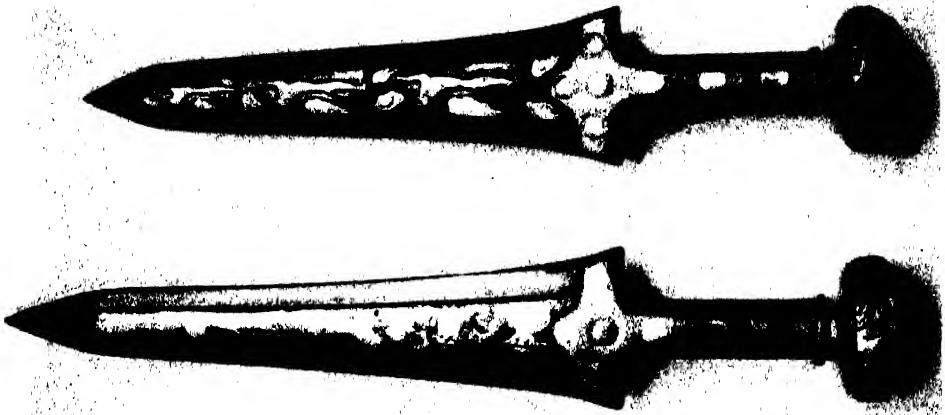

BRONZE DAGGERS WITH METAL INLAY FROM MYCENAE, 1600-1100 B.C.

weakened them, enabling the allied forces to hammer out a stalemate.

No one is more keenly aware than the writer of the shortcomings of such an account as this. It does not pretend to, and could not possibly, evaluate even the major points of the evolution of scientific warfare of the present. All it hopes to do is to show a few of the features, illustrating them by historic examples, and referring the interested reader to such

authorities as Jomini, Clausewitz, Fuller and others; and perhaps to touch very briefly upon the present war and show the most notable recent strategic advance.

When Germany entered upon this present campaign her evil geniuses, working in closest harmony with the Great General Staff and the financial and economic authorities, made possible quick triumphs in selected areas largely by the



Photo by the Author.

LOOKING ACROSS THE WHITE RUIN AND SAPPHIRE AEGEAN
FROM THE TELESTERION AT ELEUSIS TO THE LOW POINT WHERE HAUGHTY XERXES SAT ON HIS GILDED
THRONE TO WATCH THE ANNIHILATION OF HIS FLEET IN THE GREAT BATTLE OF SALAMIS.

use of an incredible long-range weapon: the psychology of fear and defeat. Coupled with that ran a system of espionage and sabotage compared with which the efforts of World War days were infantile. The story should be familiar to every adult mind, since it unraveled its tangled skeins of cruelty and destruction in Austria, Czecho-Slovakia, Norway, Belgium, Holland and devastated France. The obscene brutalities of 1914-18 have been surpassed in the German effort to destroy not only the physical courage and will-to-resist of her enemies, but their very souls as well.

This effort will fail, so far as Britain, China and the United States are concerned because the psychology upon which the strategy is based is false. We know completely the vileness of such an

effort, the subtle insinuations of subversive propaganda and fifth column activities; we hear and are unintimidated by the threats and pretense rumbling out of the Far East; we recognize and discount those "foes of our own household" who by their inchoate treason aid and comfort the enemy. And we are basing a sound strategy, a wise tactical implementation and training upon our knowledge, convinced that we wish no part of war, but recognizing that if fight we must, our salvation will rest in our comprehension of the now complicated strategy which both precedes and accompanies operations, and our ability to excel any possible opponent in the tactical use to which we put our vast and hitherto hardly tried spiritual and material resources.

SCIENCE AND SOCIETY

WHILE scientific knowledge is providing unparalleled instrumentalities for achieving an orderly and humanly significant social life, science can not minister effectively nor safely to man and his society until it is oriented to our contemporary social life and coordinated into the complex functioning of our culture. To-day ignorance of human behavior and social organization and the prevailing unawareness of the functioning of our culture are blocking the full utilization of scientific knowledge. Thus we have the ironic and tragic spectacle of science contributing effectively to man's physical comfort or to his destruction, but seemingly helpless to advance his social and cultural aspirations.

The relation of science to society involves more than questions of the organization and immediate application of scientific results through technology and professional practice; it raises the more important issues of the place, function and especially the responsibilities, of the scientist in the present-day social situation

and cultural confusion. There is a serious lag between scientific knowledge and its application to human needs, but there is also a widening gap between the scientist and the layman, to whom science and technology often appear as esoteric pursuits.

Moreover, the very rapid progress of scientific knowledge has rendered obsolete much of our traditional culture and ancient beliefs and in so doing has fostered individual confusion, distortion and insecurity. Personalities so disturbed can not function adequately as individuals nor participate as members of a society which is seeking resolution of its difficulties by voluntary cooperation. The increasing social disorder, affecting those countless millions in all lands who have been cut loose from their inherited social, economic and ethical moorings, has rendered them subject to devastating exploitation by distorted, but plausible, fanatics. To-day society itself has become the patient.—*Josiah Macy, Jr., Foundation Report for 1937-1940.*

SAILING CRAFT OF RECIFE, BRAZIL

By Dr. E. O. HULBURT

NAVAL RESEARCH LABORATORY, WASHINGTON, D. C.

On the voyage to Brazil in September, 1940, the eclipse expedition of the National Geographic Society and the National Bureau of Standards spent several pleasant days at Recife, the capital of the State of Pernambuco. This is a city of about 400,000 inhabitants and is the most eastward port of Brazil. It is of old Portuguese architecture and being built around several tidal estuaries is often referred to as the Venice of South America. Statistics of Recife showed that, in 1939, of 1,503 commercial craft which used the port, the motive power of 555 was sail. It needed only a single glance at the harbor to bring a sparkle to the eye of any yachtsman. The water was thronged with two fascinating types of sailing craft, the *barcaças* or coastwise schooners and the *jungadas* or sailing rafts of balsa wood.

The climate conspires to make the region a sailor's paradise, for the southeast trade wind blows steadily a perfect 10

knots night and day unceasingly. It is an on-shore breeze and one can sail in either direction along the coast with the wind rarely forward of the beam. The sea is always smooth, occasionally flecked with a few whitecaps, and a warm surf tumbles gently on the sandy beaches. It is said that storms never come. In the rainy season from April to August there are plenty of scattered showers, but through it all the sea breeze blows sweetly, the mainsheet pulls steadily and the boat slips along on a gentle tropic sea with the bowsprit swinging to the Magellanic Clouds. No wonder there was a never-ending procession of little white dots down the coast line as far as the eye could see. They were the *barcaças*, the trading schooners of Pernambuco, bringing coconuts, lumber, sugar, coffee, pineapples and melons to the big city.

The *barcaças* were 50 to 70 feet in length, 10 to 14 feet beam and about 5 feet draft when normally loaded. Like



TWO-MASTED BARÇAÇA.



THREE-MASTED BARÇA.

all freight-carrying craft they were staunchly built, the planking being 2 to 4 inches thick. They were moderately bluff bowed with hard bilges and long easy lines. They had no center-board



JANGADA UNDER WAY.

and practically no keel, and would stand upright when allowed to ground out over the eight-foot tide. The rudder was out-board and worked by a tiller; there was no bowsprit. Whether the barça had two or three masts appeared to depend on the taste of the owner or designer rather than on the size of the boat. All the sails were gaff-headed, being laced to the gaff, boom and mast with spiral lacing. There was a minimum of metal fittings. The front mast was stepped in the peak of the bow like the mast of a catboat. The sail of this mast, called the "mizene," overlapped the next mast aft by 6 to 8 feet. There was a lift toggle from the end of the mizene boom to the eye of the next mast. In coming about one or two men at the toggle hoisted the boom to a high angle until it passed by the mast and then lowered it again. Evidently the gain in sailing effect from the overlapping mizene more than compensated for the awkwardness of the maneuver. The sails were baggy and well cut. There were no reef points and no standing rigging or stays of any kind on the masts. This was eloquent testimony of



BARÇA ENTERING THE HARBOR.

the geniality of the weather. The masts were of a tough and heavy wood which by dint of much questioning and thumbing of the Portuguese dictionary I discovered to be "mast wood." Each boat carried a balsa wood raft or jangada as a tender, sometimes rigged for sailing and sometimes just plain raft.

Names of *barcaças* were Zulaida, Sonia, Lindya, Ametisto, Allianco, Bom-conseho and many saints. The *barcaças* were innocent of engines; they went places by sail. At almost all hours of the day one could see several working their way by short tacks up the mile-long narrow outer harbor, drop their mainsails, shoot through the draw and continue under *mizene* alone to anchorages or berths in the inner harbor.

The *jangadas* were sailing rafts of balsa wood logs used for fishing and pleasure. They were 14 to 20 feet long, 3 to 5 feet in width, and made of 5 to 8 logs joined together by long wooden pins. Each log was roughly narrowed at the

ends and so chosen and put together that the *jangada* narrowed at each end with some upward curve or sheer at bow and stern. A center board was thrust down a slot between the center logs. Steering was with a long oar. The mast was very curved and the sail three-cornered with a sprit. The upper mast step was a strong piece supported athwartship on stout legs about two feet high. The lower mast step was one of several holes in the logs, and by selecting a particular hole the mast could be set at a port or starboard slant to suit the sailing conditions. When running before the wind a temporary backstay to the top of the mast was often used. The sail was lowered by disengaging the sprit, gathering the sail around the mast and unshipping the mast. The *jangada* pictures were kindly given to me by Mr. Arthur A. Hoag, of Brown University, who was as much interested as I in the sailing activities of Recife.

The home port of the *jangadas* ap-

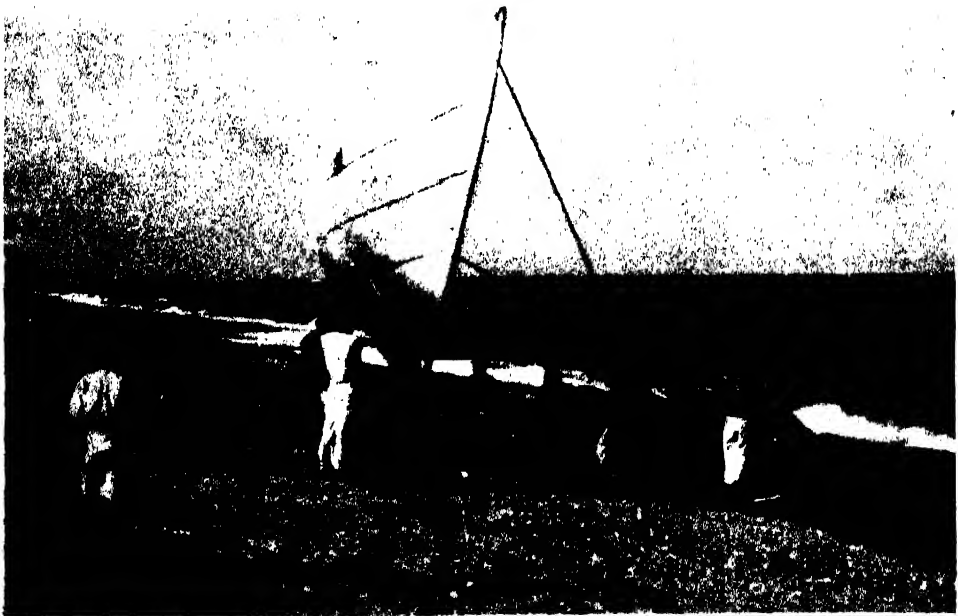

PUSHING AND SAILING A JANGADA UP THE BEACH.

peared to be the nearest beach, although at times they did not scorn the harbor entrance. But their usual influx and efflux was by way of the surf. The larger sizes were distinctly heavy and required several men to push them on rollers above the high tide mark. They were not painted, and once on the beach they were immediately propped up or tipped on the side for drying. The jangadas were apparently planned to progress mostly by sail, for there was no provision for rowing and they were heavy to paddle; the

only oar they carried was the steering oar. Under sail they were fairly agile and would work to windward; in fact they sailed as well as might be expected. The usual crew was one or two barefoot people, one perched near the mast step and the other on the stern seat with the steering oar. It was said that they often go fifty miles off-shore. On the occasion of a visit from President Vargas we watched a parade of over fifty jangadas sailing a sort of "follow-the-leader" in single file. It was a pretty sight.

STUDENT LIFE IN THE UNIVERSITY OF PUERTO RICO

By Dr. JAMES G. NEEDHAM

EMERITUS PROFESSOR OF ENTOMOLOGY AND LIMNOLOGY, CORNELL UNIVERSITY

AFTER retirement from half a century of teaching of American students, I was recalled to service by an invitation to

become a visiting professor for a term in the University of Puerto Rico. I was curious to know what Puerto Rican youths are doing and thinking, and I went gladly. I lectured to a large class and went afield with a small one. I attended public lectures, concerts, athletic meets and social affairs in great variety, and I talked with many students privately. I saw Puerto Rican youths at work and at play, in lecture rooms and in laboratories, on the campus and in the mountains, in private conferences and in assemblies; and in all, I had great pleasure in associating with them.

I found them quite like students elsewhere; perhaps a little more volatile than ours at the North and a little more prone to argumentation; but, gay, care-free, ready to dance to the first strains of suitable music; but withal, thoughtful and very conscious of being in training for life. The work done there by my classes would stand comparison with that done by similar classes at home. The average of intelligence and of industry was quite as high.



THE ADMINISTRATION BUILDING WITH THE ROOSEVELT BELL TOWER. THERE ARE CHIMES WITHIN AND AN AVIATION BEACON ON THE PEAK OF THE TOWER.

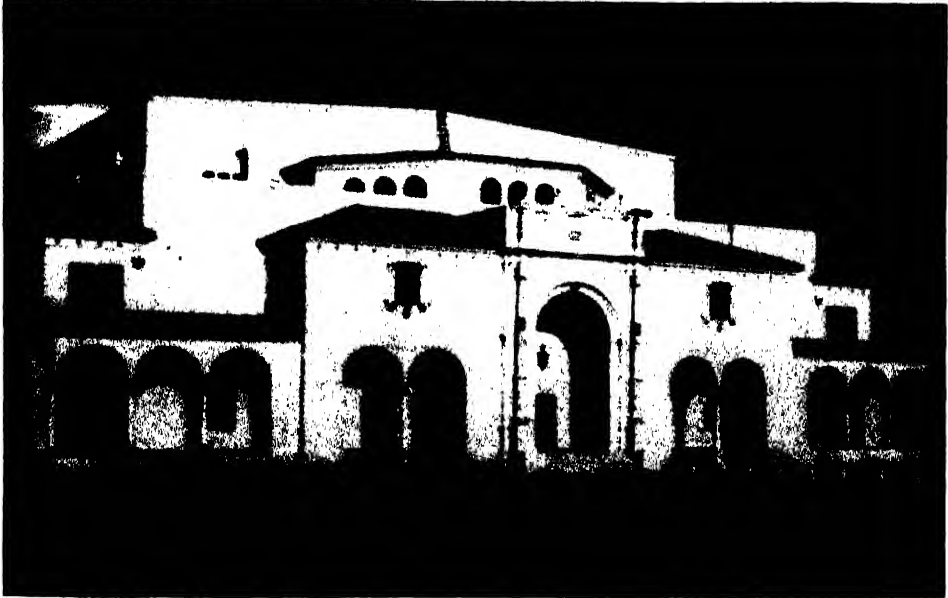

THE AUDITORIUM OF THE UNIVERSITY OF PUERTO RICO
FUNDS FOR IT WERE PROVIDED BY THE PUERTO RICAN RECONSTRUCTION ADMINISTRATION.

The slight differences are mainly traditional in origin. Puerto Rico is essentially Spanish, and young Puerto Rico is proud of its Spanish traditions. It never forgets that the discovery of the New World began in its own neighborhood of islands, and was made possible by the patronage of a Spanish queen.

The university is bilingual. Professors are free to conduct their work in either English or Spanish, as they may prefer. Lectures in scientific subjects are all given in English. The students all know English, but they do not use English except when necessary, and then haltingly, and with none of the fluency that characterizes their use of their native tongue.

There is much discussion of governmental matters among Puerto Rican students outside the classrooms. They study our Constitution, and ask why its principles are not applied in the Island. They are puzzled as to why our government, that their fathers welcomed a gen-

eration ago, still rules the Island with dictatorial hand; why it calls them Americans and yet still withholds full citizenship from them; why it does not allow them to choose their own rulers and why it does not make them responsible for their own affairs.

Many of the best students would like to continue their studies in our continental universities. A few of them are able to do so. A very few of our northern students do graduate work in Puerto Rico. There should be more students going both ways; for the Puerto Ricans would expand their knowledge of our great country, and our own students would learn something of the conditions of life in the tropics. Ours would have all the advantages of sanitary living conditions in a beautiful environment, with colleagues who know the Island well and are eager to aid them in their own researches upon tropical life.

Without waiting for the establishment of the proposed great Inter-American



THE ATHLETIC ASSOCIATION MASCOT

University that was planned by the President's committee last year, some of



A BASKETBALL GAME
STUDENTS OF THE UNIVERSITY OF PUERTO RICO IN
AN INTRAMURAL GAME.

its most desirable objectives might be had by exchange of students with the university already there. The more that our youths who differ in upbringing are permitted to seek the truth together, the better will be the relations between them as citizens of a common country.

The University of Puerto Rico is only forty years old. It was begun at Fajardo in October, 1900, as a normal school for the training of teachers for the Island. It was removed to Rio Piedras, a suburb of the Capitol and principal port city of the Island, San Juan, in 1903, and made a university in name and in purpose; and with continued and substantial support from the legislature of the Island, it has now attained to the stature of a real university. During the past decade I have visited it three times at five-year intervals, and I have been delighted to see the progress it has made.

In the matter of housing the Puerto Rican Reconstruction Administration has been a godsend to the university. Beautiful new buildings have been erected where most needed; dignified, serviceable and well designed for their uses. The presence of such buildings has made a marked improvement in the attitude of the students toward their university. They take pride in its appearance and in its maintenance in good order.

Recent improvements have followed a plan of future development, and have included some effective landscaping of the front of the campus. There is a fine view westward from the front of the main buildings, and I have often lingered there at time of sunset to enjoy it. A broad lawn slopes downward to the three front entrances. The direct path to the middle gate is bordered by the plume-crowned columns of a double line of royal palms. The semicircular drive that borders the lawn and runs out to the two carriage entrances, encircles a bordering line of fig trees: broad bushy

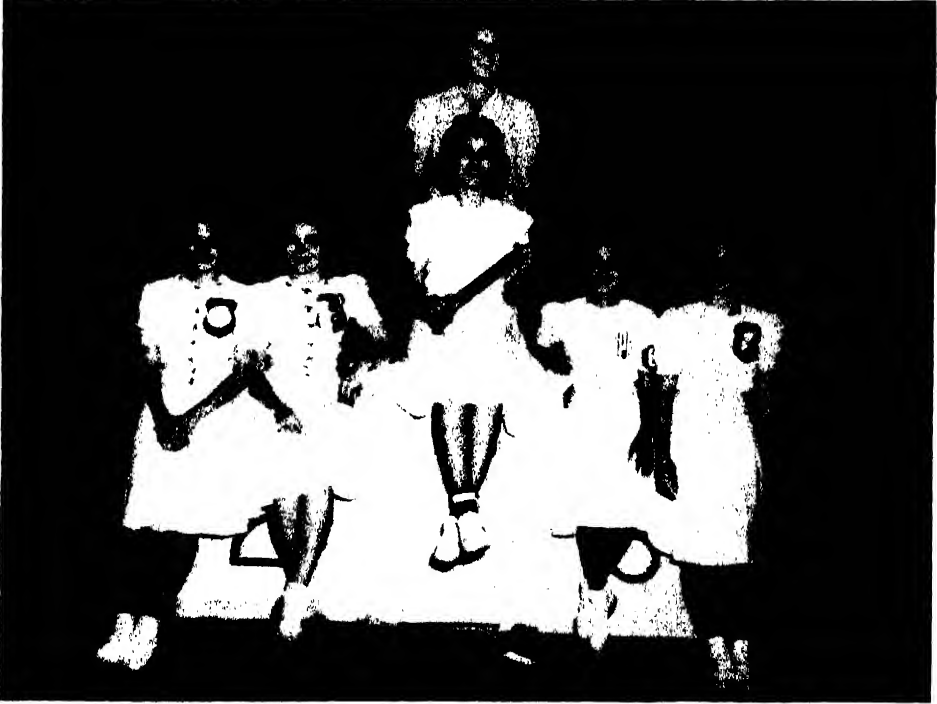

ELECTED GIRL REPRESENTATIVES OF THE STUDENT BODY CENTER, WITH TROPHY, IS THE UNIVERSITY QUEEN, SENORITA EDNA MENDEZ (WHO IS NOW A GRADUATE STUDENT AT CORNELL UNIVERSITY); THE OTHERS, "MADRINAS," REPRESENT SPORTS (LEFT TO RIGHT) BASKETBALL, TENNIS, FENCING AND TRACK. THE LADY BEHIND THE QUEEN IS AN INSTRUCTOR IN PHYSICAL EDUCATION.

trees, with masses of heavy evergreen foliage, multiple boles and dangling aerial roots. Beyond the gates and the town an undulating mass of foothills stretches away inland to the high mountains in the far distance, and outward they slowly fall away to the shoreline of the blue Atlantic. The students may well be proud of their native homeland, for it is one of the most beautiful islands in the world.

The university is doing its best to keep in touch with educational trends by granting leaves for study in the States to members of its teaching staff, and by maintaining exchanges of professors

with some of our best universities. Our men who go down there return to speak of their experience as a great privilege. They have had a chance to study life in the tropics where there is a great variety of environmental conditions near at hand, and where the people are very hospitable. The winter climate in Puerto Rico is delightful.

Here at this university is the best place in the New World for the improvement of cultural relations. It is the place where our community of interests in seeking knowledge is unquestioned. It is the place of greatest advantage for the growth of mutual understanding.

SUBSISTENCE MANUFACTURING¹

By Dr. RAYMOND CRIST

DEPARTMENT OF GEOGRAPHY, UNIVERSITY OF ILLINOIS

Thou shalt not muzzle the ox that treadeth out
the corn.

The labourer is worthy of his reward.

—I Timothy 5: 18.

ACCORDING to many text-books man goes through various phases in his upward march from the hunting and collecting stage of economic development, through shifting to sedentary agriculture, and on to the embryonic stage of manufacturing—this word used in its original sense, *viz.*, hand-made. This sequence is said to be the natural one, each step supposed to represent an economic and social advance over the one preceding it. Occasionally one or more steps in this evolutionary process have been skipped; furthermore, they do not, in the order named, always mean progress; indeed, under certain conditions a change from agriculture to manufacturing may, in the long run, signify a retrograde movement for the people concerned.

In the semi-arid region around Barquisimeto, Venezuela, a relatively low-lying area swept over by the drying trades much of the year, the early explorers—here both Spaniards and Germans—found an Indian population that was not at all highly developed. One great boon to these primitives was the introduction of the goat, an animal admirably adjusted to the xerophytic vegetation of that area. From then on there was much more stability in the food supply, and with the rise of Barquisimeto as a regional capital, because of its key position where the routes from mountains, plains and sea converged, the people

¹ The work on this article was made possible by grants from the John Simon Guggenheim Memorial Foundation and from the Graduate Research Board of the University of Illinois.

became relatively prosperous. The economy of the rural people began to change from that of hunting to that of grazing with some agriculture.

With the expansion of trade following the development of routes, some industrial development was possible, and there was conveniently at hand an indigenous plant, the cocuiza (*Fourcroya Humboldtiana*), a perennial with smooth leaves five or six feet long, containing strong fibers known as Fique, valuable for the making of hammocks, sandals, ropes, twine and sacks. It is also used for making a popular potent rum called cocuy, similar to Mexican mezeal. This useful and drought-resistant plant can be grown with ease in Venezuela in extensive areas, at present almost completely unproductive. It does not quickly use up the soil elements, and thrives in dry, stony places where some lime is present. After the first year it does not require much attention. The woody part of the trunk gradually hardens with age and the fiber-bearing leaves are ready to cut when the plant is six or seven years old. At least 25 leaves should be left on the stock at all times during the producing period, which ends when the plant has attained 18 or 20 years.

The leaves are tied up in bundles and carried or hauled to the machine which extracts the fiber. It is then hung out to dry. Many phases in the elaboration of useful articles out of this desert plant, which were formerly done by hand, are now done by machines. In Barquisimeto there is a sisal sack factory with a capacity of 1,000 sacks a day, which has a machine for each of the twenty operations necessary in the making of the

finished product; yet people in the country who make sacks in their homes on hand looms still compete successfully with the products of the mass production factory.

Two families who are competing with the machine were visited on August 4, at El Rodeo, on the road to Qúibor. The Perez family is typical. Up to five years ago this family lived almost exclusively from its flock of goats, which were kept at night in a corral near the house. This source of steady income was suddenly snatched away by the death of all the goats from a plague, and the family was confronted with the task of making a living by other means. The goat corral was immediately planted in cocuiza. This is not more than half an acre, but it is something. But since it takes at least five years before the plant produces leaves with fiber of the proper tensile strength, something had to be done in the meantime for daily bread. Then a hand loom was built. About this time Mr. Perez was killed in one of the local revo-

lutions which have victimized the poor people of more than one Latin American republic. His widow, now only 29 years old, who was married at the age of 12, and his four children were left completely destitute. But the feeling of family solidarity is strong, and life's realities had to be faced. The older woman, her daughter and four grandchildren set to work making sacks with fiber borrowed from the local storekeeper.

Every step in the manufacture of sacks, except removing the fiber from the leaves, is done by the family. The cocuiza fiber is kept in the house so as not to become too dry. The workers sit on the bare earth floor inside the house while making string. They kindly moved outside awhile so that pictures could be taken. The little girl hands a few strands of the fiber to the grandmother, who twists them into a string by rubbing them on her thigh, which from constant use at this work is just one huge leathery callous. The girl keeps feeding the fiber onto her grandmother's tough thigh,



MACHINE-EXTRACTED COCUIZA FIBER DRYING AT EL RODEO.



L. J. Williams

A STAND OF COCUIZA

THE FORMER GOAT CORRAL OF THE PEREZ FAMILY
WHICH IS NOW PLANTED IN COCUIZA.

from which comes a thick heavy string which she doubles over in her hand preparatory to staking out in the yard for shrinking. After that it is wound on a spindle a foot long and is ready for use on the loom.



MAKING COARSE STRING FOR WOOF

The finer string that is strung in the loom is made by a different process. The oldest boy, a fine young lad, takes in his left hand a little hand-made frame in which there is fastened a tiny fly wheel on a rod. Then with his right hand he grasps a wooden handle some eight inches long to which is attached a rawhide loop. By working the handle deftly up and down the thong grips the rod and the wheel keeps turning round and round in the same direction. The fiber attached to the farther end of the axis is twisted into a fine string which lengthens as more strands are fed into it. As it gets longer the boy moves away from his mother until there are 30 or 40 feet of string. This is wrapped onto a ball and the operation is repeated.

Thus the entire family is kept busy, often from five in the morning till eleven at night, either at the loom, making string of one grade or another, or running errands. The finished products are carried, usually on the heads of the women, to the local storekeeper, through whom they are sold. He makes a profit in supplying the fiber and in selling the sacks, and unfortunately all that the family consumes in any way must come from the same store. The result is that they are always in debt to the storekeeper, just as the Mexican peon was to the "tienda de rayo." If the family has enough black beans to keep body and soul together, they rejoice. There is little use to ask how much the family makes in money. It is never enough to meet their very meager expenses. Money is in reality rarely seen. For the producers this is barter economy at its worst.

A neighboring family was visited, and there was the same story of poverty, misery and squalor. Fortunately, the man of the house was alive and active. He had two looms, for different grades of sacks. Most of his time was spent bent over a loom. In front of the house was

a pile of wood from which he was about to make charcoal. The problem of obtaining enough fuel for cooking is everywhere acute. It hardly seemed possible that his little house, which appeared to be a part of the semi-arid natural landscape with which it blended so perfectly, could be the scene of such unremitting, unremunerative drudgery.

These families are just one jump ahead of starvation. When sickness comes, utter destitution is their lot. Aid from the storekeeper means more indebtedness. The Federal Government did help them out last December with some medicine, but there is a crying need for education in the rudiments of hygiene. The drinking water is taken from an artificial pond, or jaguey, ideally located behind the store, to become what really amounts to a cesspool. As long as this is used without boiling, sickness is inevitable.

Once the patient or patients are able to be on their feet, they must jump into the work again. Their life is little more than a treadmill—an existence, not a living. They are living on the land, yet are completely uprooted from it—not drawing any of their food from it directly. Although bound to the land by only a very slender cocuiza thread, they are unable to cut loose and move off. They are condemned to suffer most of the privations of the savage, without his sense of personal freedom; not only is their horizon narrower, they have no opportunity to develop even his rude resourcefulness. Perhaps it is just as well that they are geographically and socially immobile—they thus remain unaware of blessings that they could never hope to enjoy.

There was not a stick of furniture in the house—not even a box to be used as a chair. The family slept in dirty hammocks suspended from cross-pieces. There was not even a tiny flower pot, an object often seen in the most lowly hut. Life here is too real and earnest; there



STAKING STRING OUT TO DRY
THE BIG CACTUS PLANT IS ONLY FIFTEEN OR
TWENTY FEET FROM THE HOUSE.

is no time for cultivating a taste for the beautiful. Yet, in all fairness, it must be said that these people with a horizon bounded at farthest by the cactus plants a few feet from their home received us with grace and dignity. They were at ease and made us feel at ease. They



L. J. Williams
MRS. PEREZ AT HER LOOM

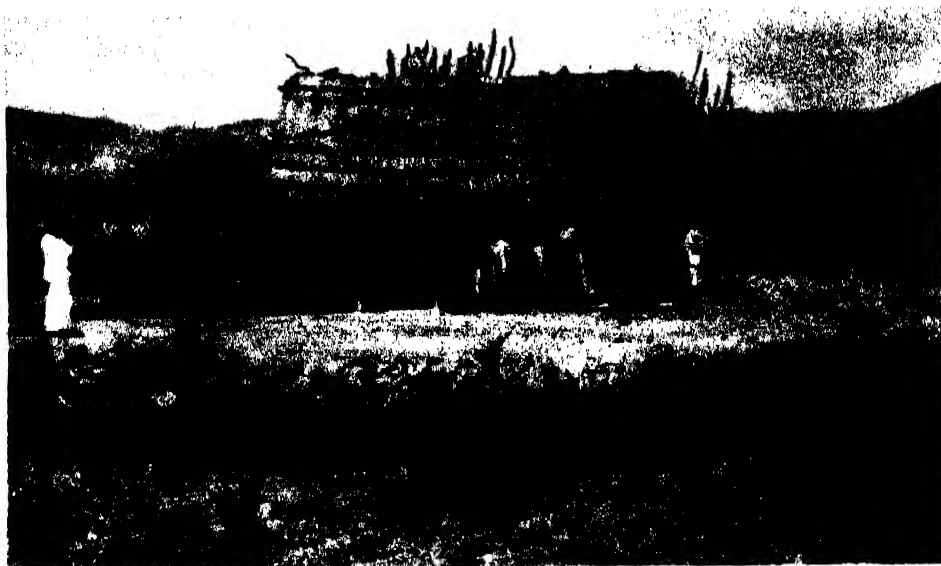

MR. MENDEZ' HOME, HIS WIFE AND FOUR CHILDREN

NOTE THE SECOND LOOM UNDER THE LEAN-TO SHELTER AT THE LEFT. THE PILE OF WOOD IN THE FOREGROUND IS TO BE MADE INTO CHARCOAL. THE MAN TO THE LEFT IS THE LOCAL STOREKEEPER.

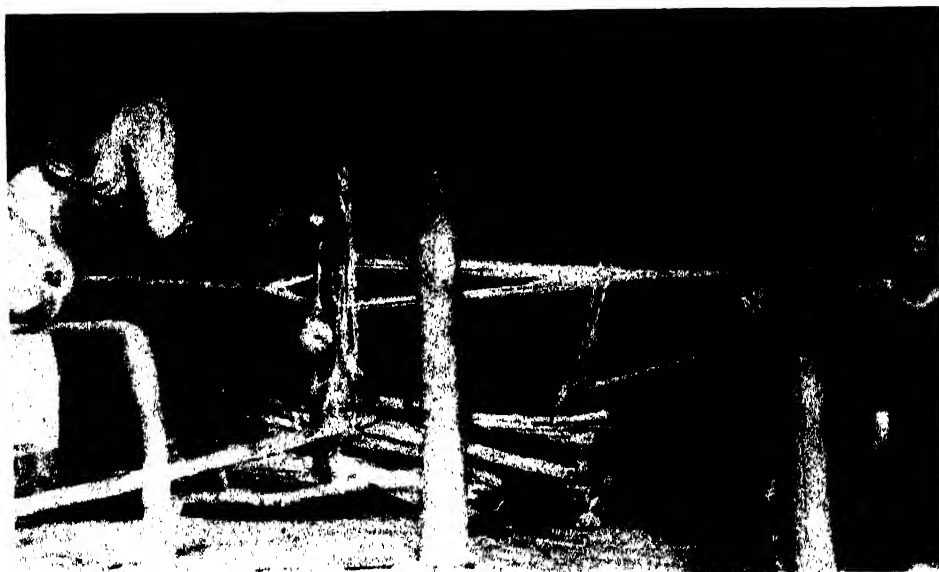

MR. MENDEZ HARD AT WORK ON HIS LOOM
ONE OF HIS POORLY CLAD CHILDREN STANDS AT THE RIGHT.

kindly went into details in answering our questions and were neither shy nor forward—a distinct contrast to the pseudo-sophisticated storekeeper and his hangers-on, who lived on the road and were in daily contact with many people. These people, cheerful, courageous and industrious in the face of appalling conditions, will never need to read Emily Post.

The big question for these marginal families is not whether they will continue all their lives being in debt to the storekeeper, but whether technological progress will not wipe out even their present means of subsistence. Already the machine has taken over the work of extracting the fiber from the leaves. There is the big sack factory in Barquisimeto to compete with. These families are past the self-sufficient stage in economy. They can no longer directly satisfy their wants; they must do so indirectly through the concurrence of many others in an enormous chain of producers and consumers. If one small link breaks, the whole mechanism stops short. They will continue to be workers if "business continues as usual," but they will be on the scrap heap with even a slight technological change. It is no credit to civilization if people in it look with regret upon the savage state. Yet merely paying these people a bonus if or when they become technologically unemployed would only mean temporarily anchoring submarginal operatives on submarginal land.

The word integration has been overworked, but it is still useful. There are thousands of people in the world like these two families in the interior of Venezuela who must be integrated not

only into their regional economy, but also made to fill a niche in our world-wide mechanized society. The Huns and Vandals would have been quite unable to shatter the Roman Empire if the competition of enslaved captives had not created within the Empire a great body of unemployed "freemen," who, tired of bread and circuses, felt that any change would be for the better. If the families discussed in this paper, and their peers all over the world, are gradually "freed"



MAKING FINER STRING FOR WARP

by technology without at the same time being able to achieve a sense of "belonging" to our present society, they may confidently be expected to do for it what the Huns and Vandals did for the Roman Empire.

Why hesitate! Ye are full-bearded men,
With God-implanted will, and courage if
Ye dare but show it. Never yet was will
But found some way or means to work it out,
Nor e'er did Fortune frown on him who dared.

—E. R. TAYLOR.

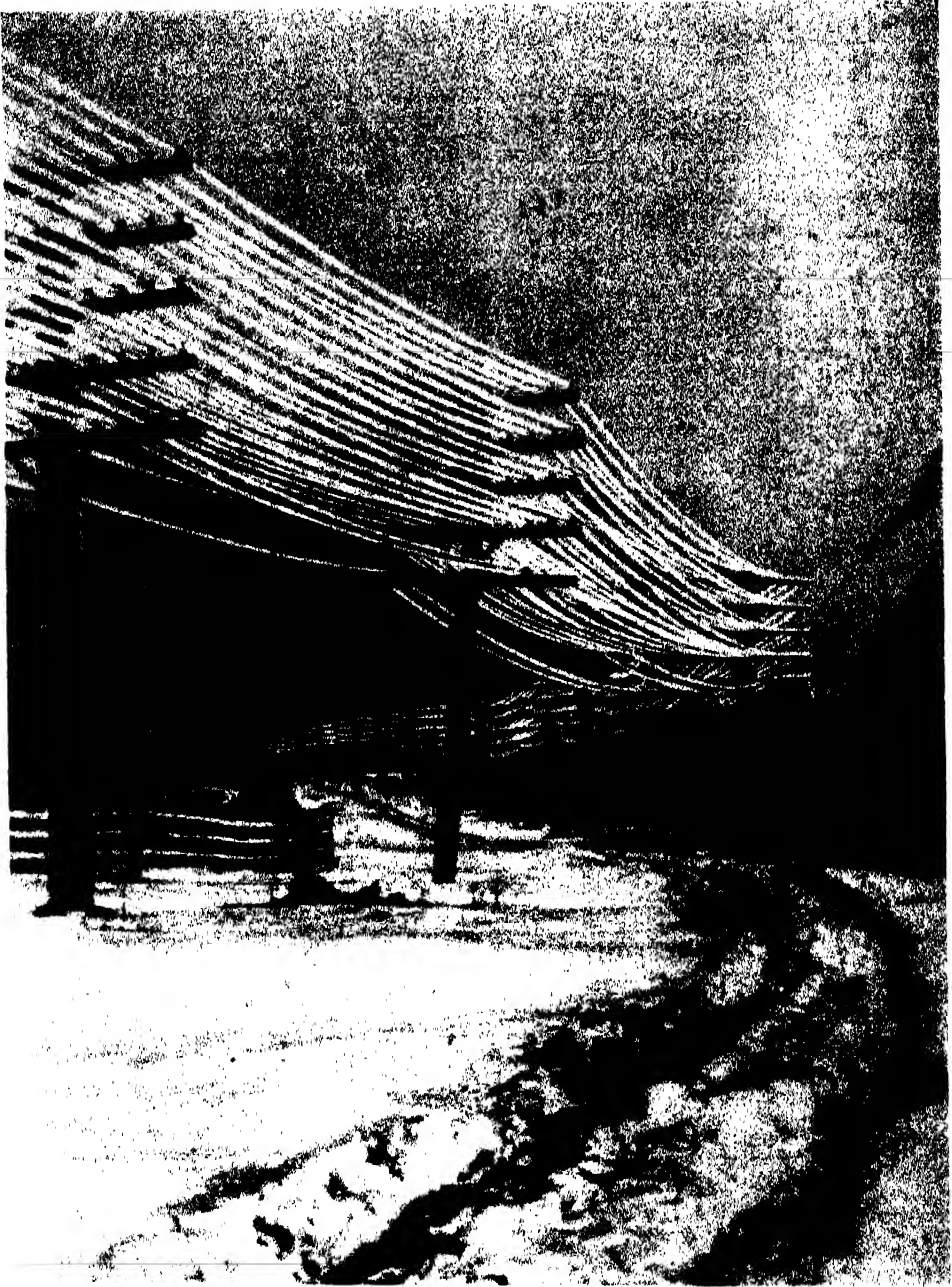

TELEPHONE LINES HEAVILY FESTOONED WITH SLEET AND SNOW
THESE STURDY SENTINELS OF COMMUNICATION HAVE WITHSTOOD THE FURY OF THE STORM AND
EACH LINE IS STILL CARRYING ITS QUOTA OF MESSAGES.

YOUR VOICE AND THE TELEPHONE

By Dr. FRANKLIN L. HUNT

BELL TELEPHONE LABORATORIES

IF some one at New York could shout loud enough to be heard at San Francisco and some one there should shout back immediately on hearing the message and loud enough to be heard at New York, the New Yorker would have to wait over eight hours for a reply because it would take that time for sound waves to traverse our continent twice. By substituting electric for acoustic waves, however, and wires for the air this fantastic supposition becomes reality and the reply to words spoken in an ordinary tone of voice comes back so nearly instantaneously that there is no noticeable delay. We have become so accustomed to transmit speech thus over great distances by telephone, that we seldom stop to consider that only within the short span of a single lifetime in the long history of human endeavor has it been possible to project one's voice more than a few hundred feet. Sixty-six years ago the first words were sent over telephone wires, twenty-six years ago our continent was first spanned by telephone and only within fifteen years has commercial transoceanic telephony become practical. Since then progress has been so rapid that it is now possible to sit in our own homes and call nine out of ten of the approximately 40 million telephones in the world of which more than 21 million are in the United States.

This vast communication system has been accommodated to the unique characteristics of the human organs of speech and hearing, and many years of effort have been spent by scientists and engineers to learn how best to transmit the feeble energy of the human voice over telephone lines.

THE ORGANS OF SPEECH

The human speech organs are a remarkably flexible and versatile arrangement for producing tones of a wide range of pitch and quality and yet as a mechanical structure they are surprisingly simple. Air from the lungs, which acts as a bellows, passes through the wind pipe to the vocal cords—two muscular bands stretched across the upper end of the windpipe to form a slit. The passage of air past the edges of the vocal cords makes them vibrate, thus producing sounds which pass up to the mouth and nasal cavities where they are modified by the mouth, tongue and teeth and given the distinguishing characteristics of speech. The vowel sounds are the low-pitched components of speech and they carry most of the energy. Intelligibility, on the contrary, is largely due to the high-pitched consonants added by the tongue, teeth and lips. A satisfactory telephone system must therefore transmit high enough pitches to include these consonant sounds.

THE ORGANS OF HEARING

The mechanism of hearing is more complex than that of speech. The sound heard impinges on a diaphragm in the outer ear beyond which is a group of three small bones. They convey the vibrations from the diaphragm to the inner ear, where the real organ of hearing is located. It consists of a spiral cavity filled with liquid and divided longitudinally into two sections by a flexible membrane. Along this membrane are distributed thousands of nerve fibers—about 30,000 in all. This flexible membrane vibrates under the sound impulses

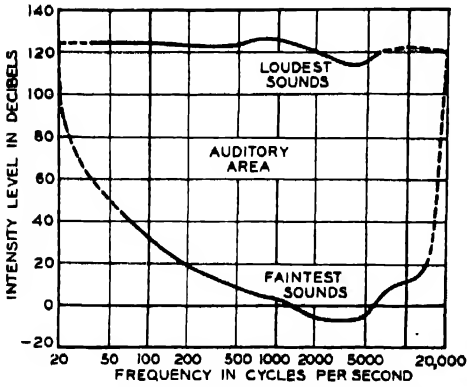

FIG. 1. AUDITORY SENSATION AREA WHICH SHOWS THE RANGE OF PITCH AND INTENSITY THAT THE HUMAN EAR CAN HEAR.

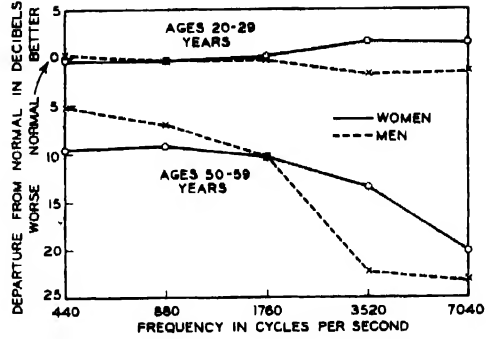

FIG. 2. HEARING LOSS COMPUTED FOR DIFFERENT AGE GROUPS. NOTE DECREASE IN ABILITY TO HEAR AT HIGH FREQUENCIES IN CASE OF OLDER GROUP. DATA OBTAINED AT THE NEW YORK AND SAN FRANCISCO FAIRS, 1939.

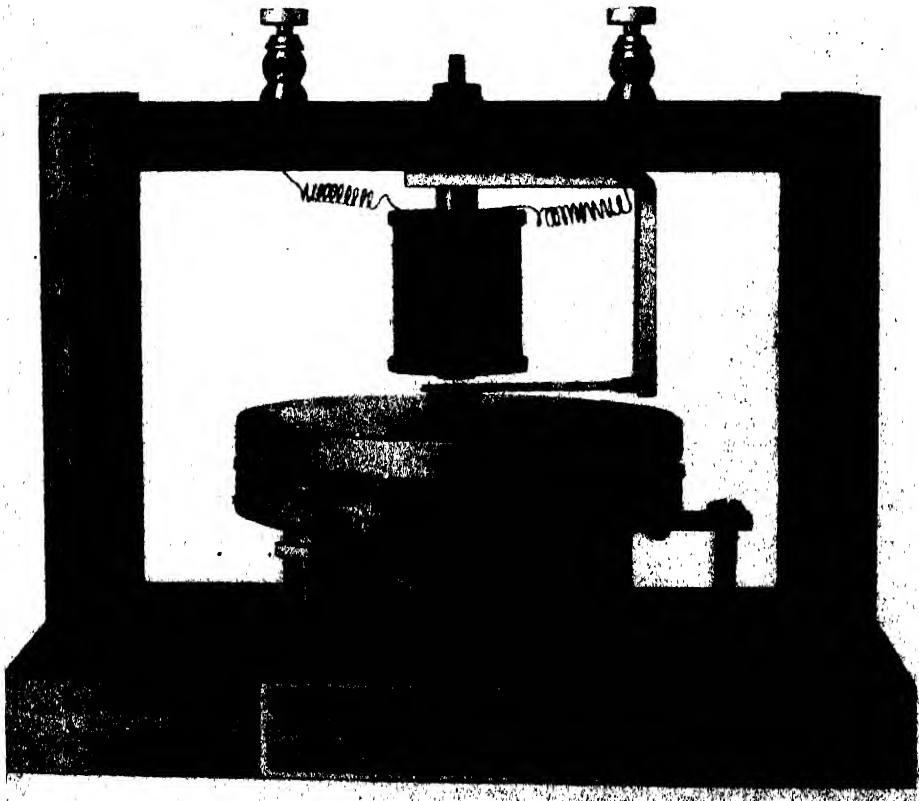

FIG. 3. FACSIMILE OF BELL'S ORIGINAL TELEPHONE THROUGH WHICH SPEECH SOUNDS WERE FIRST TRANSMITTED ELECTRICALLY IN 1875.

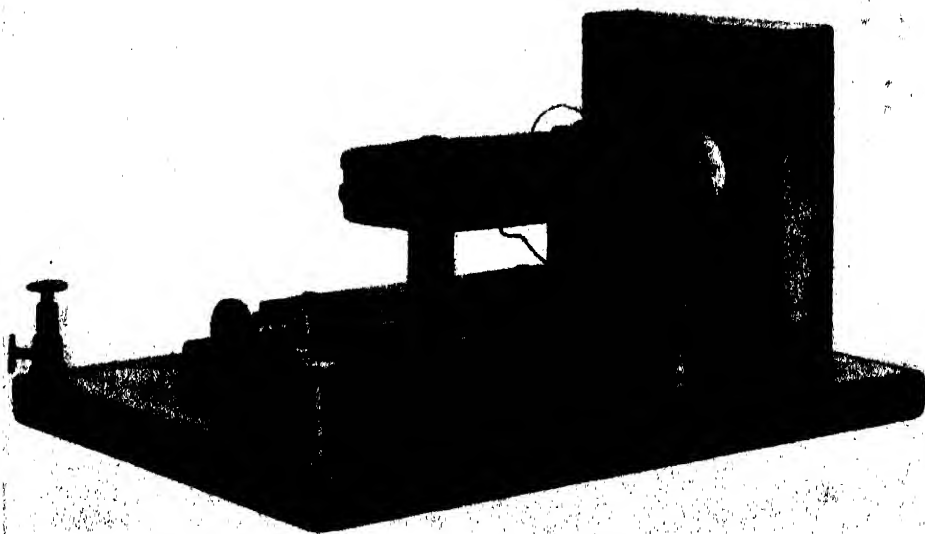

FIG. 4. THE FIRST COMMERCIAL TELEPHONE

PERMANENT MAGNETS PROVIDED THE MAGNETIC FIELD. NO BATTERY WAS REQUIRED BUT THE VOICE CURRENTS DEVELOPED WERE FEEBLE AND THE DISTANCE OVER WHICH CONVERSATION COULD BE CARRIED WAS LIMITED TO A FEW MILES.

and some of the fibers, depending on the pitch, respond and send signals to the brain. These fibers thus act selectively and make it possible to perceive sounds of a wide range of pitch.

AUDITORY AREA

Curves which show the loudest and faintest sounds of all pitches which the ear can perceive enclose an area which is called the auditory area because it includes all the sounds audible to the human ear. This area is shown in Fig. 1, where the vertical direction represents sound intensity, and the horizontal the pitch or frequency of vibration. The lowest pitch which the ear can hear, such as the low rumbling tone of a large organ pipe, is about 20 vibrations per second and the highest, for example, the squeaks of machinery or of small animals, is about 20,000 vibrations per second. The lower curve shows the faintest sounds which can be heard, such as whispering or the rustling of leaves, and the upper

the loudest tones which the ear can tolerate without pain. These curves come together at the lowest and highest audible tones. This indicates that the range of intensity that the ear can hear is much less for low and high pitch tones than for those around 1,000 vibrations per second; that is, two octaves above middle C on the piano.

The average fundamental pitch of a man's voice is about 125 vibrations per second and that of a woman's voice about an octave higher. There are also over-tones or harmonics in the human voice which extend up to about 10,000 vibrations per second, but those above 8,000 contribute little to the intelligibility of speech. It is these over-tones which give the voice its individual character, however, and they vary both in pitch and intensity with each person.

HEARING TESTS AT THE WORLD'S FAIRS

At the World's Fairs in New York and San Francisco during 1939 and

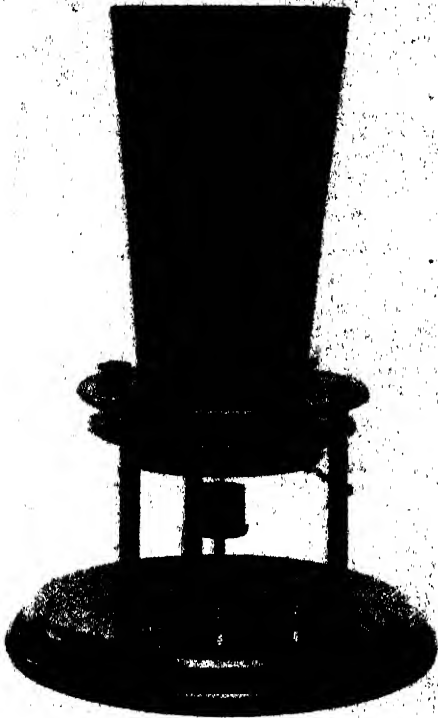

FIG. 5. THE LIQUID TRANSMITTER THROUGH WHICH THE FIRST INTELLIGIBLE SENTENCE WAS TRANSMITTED BY BELL ON MARCH 10, 1876: "MR. WATSON, COME HERE, I WANT YOU."

1940 over a million visitors had their hearing tested at the exhibits of the Bell Telephone System. This is by far the largest hearing test ever conducted and provided a mass of data on the hearing of the average American citizen which has never been previously equaled.

Some of the results, as analyzed by the Bell Laboratories' acoustical staff, are summarized in Fig. 2. The hearing loss for the age groups from 20 to 29 and 50 to 59 years are shown. The vertical direction indicates the hearing loss, normal hearing being marked 0; and the pitch is plotted horizontally in vibrations per second. In the lower age group the difference between men and women's hearing is small but slightly to the advantage of men at the lower pitches and to that of women at the higher ones. In the age group from 50 to 59 years, however, the difference is much more pronounced. Men hear low-pitched tones somewhat better than women at these ages and women hear high-pitched tones decidedly better than men, although both show an average loss of about 10 db from the younger group. This survey indicates that one out of twenty-five persons has difficulty in hearing in auditoriums, one in 125 has trouble with direct conversation, and one in 400 has difficulty over the telephone.

BELL'S FIRST TELEPHONE

No method of extending appreciably the distance that the human voice could be heard was devised until the advent of electro-magnetism, when scientists began to struggle with the problem of projecting the voice electrically over wires. Among them was Alexander Graham Bell, a professor of vocal physiology and a student of electricity. In 1875 he succeeded, for the first time, in transmitting

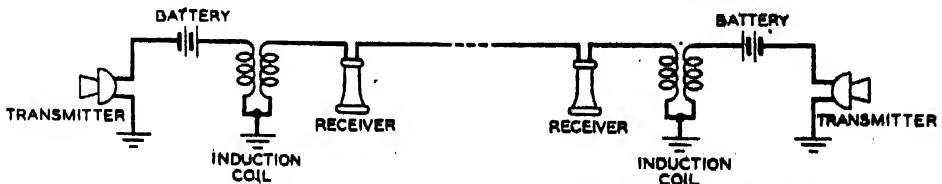

FIG. 6. EARLY TELEPHONE CIRCUIT (WITH MICROPHONE AND BATTERY) A SINGLE WIRE WAS USED; THE RETURN WAS THROUGH THE GROUND. THE INDUCTION COIL KEPT THE BATTERY CURRENT OFF THE LINE, THUS PERMITTING LARGER CHANGES IN THE RESISTANCE OF THE BATTERY CIRCUIT AND STRONGER VOICE CURRENTS. WITH THIS TYPE OF CIRCUIT AND A RETURN WIRE, TELEPHONE CONVERSATION WAS CARRIED ON BETWEEN NEW YORK AND CHICAGO IN 1892.

voice sounds with the apparatus shown in Fig. 3. To a thin leather diaphragm he attached a strip of iron held near the pole of an electro-magnet, which was excited by a battery. Induced currents of varying intensity were developed in the wires of the electro-magnet as the diaphragm vibrated and these fluctuating voice currents were carried by wires to an identical device at the other end of the line which reproduced the sound.

VOICE CURRENT TELEPHONE

Bell soon found, however, that no battery was needed if permanent magnets were used instead of electro-magnets and the first commercial telephone, shown in Fig. 4, was made with a permanent "U" shaped steel magnet which had coils of wire on its poles. The vibration of the iron diaphragm near the magnet induced currents in the coils and these currents were carried to an identical apparatus at the receiving end. This telephone was able to carry messages only relatively short distances because it depended entirely on the energy of the human voice to generate the telephone currents and this energy is extremely small, so small in fact that a person would have to talk continuously for 100,000 hours to generate enough voice energy to light a 25-watt lamp for an hour.

MICROPHONE AND BATTERY

Early in his experiments on telephony Bell found that a metal rod attached to a diaphragm and dipping into acidulated water would transmit voice currents. When the diaphragm vibrated the rod rose and fell in the liquid and changed the resistance of a battery circuit which included the rod and liquid. This was discovered when Bell spoke the first intelligible telephone message on March 10, 1876, to his assistant: "Mr. Watson, come here, I want you." A reproduction of the transmitter used is illustrated in Fig. 5. It was presently discovered,

however, that similar changes in resistance could be developed by the variations in pressure which a vibrating diaphragm could exert on a carbon button. This proved to be a more practical transmitter than the liquid type and is still used in modified form in commercial telephones. The carbon microphone and



FIG. 7. INDUCTANCE COILS

COILS LIKE THESE WERE INSERTED AT CALCULATED INTERVALS ALONG TELEPHONE LINES TO EXTEND THE DISTANCE OVER WHICH MESSAGES COULD BE SENT TO DENVER, COLORADO, FROM NEW YORK, IN 1911. THE ILLUSTRATION SHOWS FOUR STAGES IN THE DEVELOPMENT OF THESE "LOADING" COILS. ALL HAVE THE SAME INDUCTANCE VALUE.

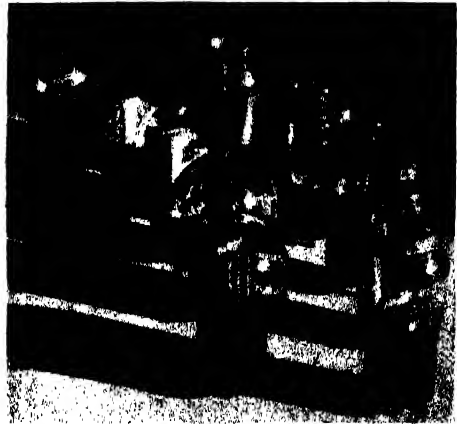

FIG. 8. VACUUM TUBES

USED IN THE "REPEATER" AMPLIFIERS TO AMPLIFY THE ATTENUATED VOICE CURRENTS AT PERIODIC INTERVALS ON LONG TELEPHONE LINES. THESE REPEATER TUBES MADE TRANSCONTINENTAL TELEPHONES PRACTICAL IN 1915. THE TUBES AT THE RIGHT ARE A RECENT DEVELOPMENT; THOSE AT THE LEFT ARE THE ONES LARGELY USED AT PRESENT. BOTH HAVE A LIFE OF MANY THOUSANDS OF HOURS.

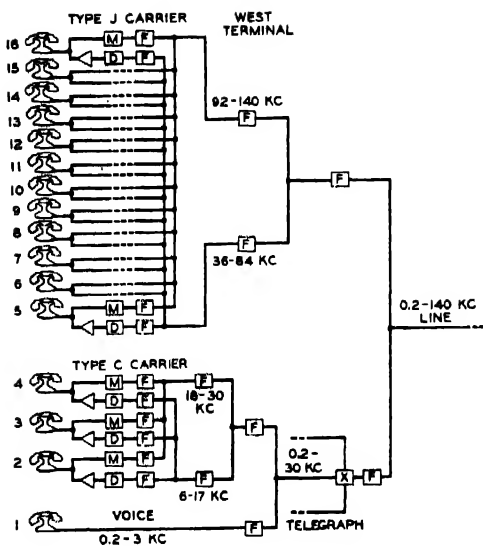

FIG. 9. CARRIER TELEPHONE SYSTEM WHICH TRANSMITS SIXTEEN TELEPHONE AND TWO TELEGRAPH MESSAGES OVER A SINGLE WIRE. EACH TELEPHONE MESSAGE IS "CARRIED" BY A SEPARATE HIGH-FREQUENCY CURRENT.

battery greatly extended the distances over which telephone messages could be sent and with circuits of this type, Fig. 6, using carbon transmitters and batteries, it finally became possible in 1892 to carry on a telephone conversation between New York and Chicago, but beyond that distance the messages became too weak to be heard satisfactorily.

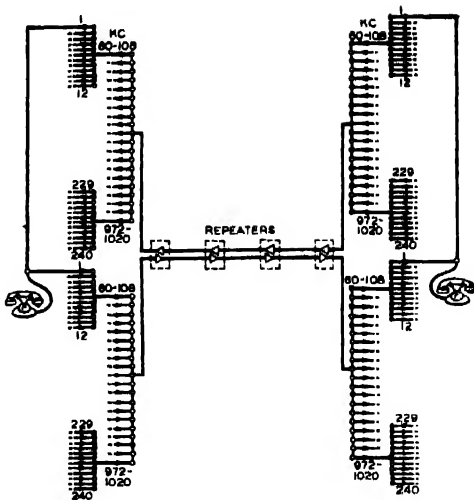

FIG. 11. COAXIAL SYSTEM SCHEMATIC DIAGRAM OF NEW YORK-PHILADELPHIA EXPERIMENTAL COAXIAL TELEPHONE SYSTEM. IT CAN CARRY 240 TELEPHONES ON A SINGLE PAIR OF COAXIAL CABLES.

LOADING COILS

Soon scientists came to the rescue by discovering that inductance coils made of iron rings with coils of wire on them, when placed at calculated intervals along the line, would decrease the attenuation of the voice currents by counteracting the electric capacity of the lines. These coils, illustrated in Fig. 7, are known as loading coils and with them communica-

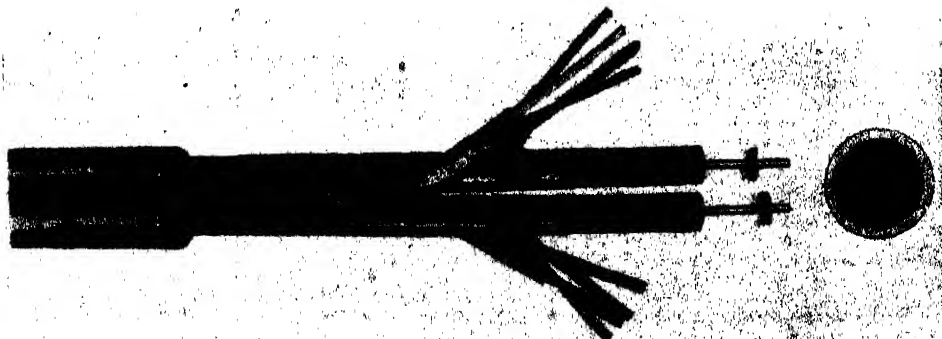

FIG. 10. COAXIAL CABLE WHICH WILL CARRY HUNDREDS OF MESSAGES ON A SINGLE WIRE, AND ITS SURROUNDING COPPER TUBE, THIS TYPE OF CABLE WILL ALSO CARRY TELEVISION SIGNALS.

tion was extended from New York to Denver, Colorado, in 1911. But here again attenuation won temporarily, and satisfactory telephony, over distances greater than 2,000 lines, was impractical at that time.

VACUUM TUBE REPEATER

Then the vacuum tube, which had recently been discovered and with which we are familiar in radio sets, showed the way to the next advance. By using it to amplify the attenuated voice currents in "repeater" amplifiers at intervals, from 150 to 200 miles along the line, much as faint radio signals are amplified for the loud speaker, it was possible to bridge the gap between Denver and the west coast and on January 15, 1915, Alexander Graham Bell at New York spoke again over the telephone to his former assistant, Thomas A. Watson, at San Francisco. A group of these tubes is shown in Fig. 8. Those at the left are largely used at the present time. The ones at the right are a recent development with increased life. Either type lasts many thousands of hours on 24-hour service.

The next step was to project the voice over the ocean by radio. In 1915 words from the radio station at Arlington, Virginia, were heard at the Eiffel Tower in Paris, but it was not until 1927 that two-way commercial telephone conversation was established across the Atlantic Ocean. Now it is possible to sit at one's telephone and literally call the far corners of the earth.

CARRIER TELEPHONY

The vacuum tube amplifier not only made it possible to carry telephone messages around the world, but it also opened the way for a more efficient use of existing telephone lines by providing means for sending more than one message over a single pair of wires. This was possible because the vacuum tube can

produce very constant frequencies of many thousands of vibrations per second which are much too high to be heard by the ear. By a method known as modulation these high frequencies can be made to act as carriers of ordinary telephone voice currents and by using a series of carriers of different frequencies several

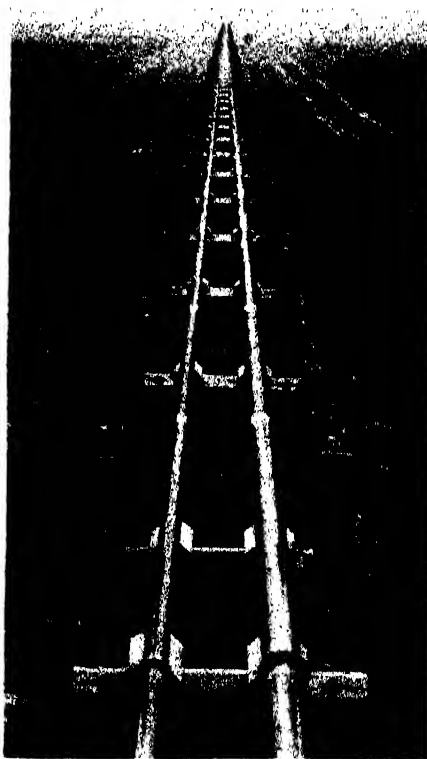

FIG. 12. EXPERIMENTAL CABLES ULTRA-HIGH FREQUENCY EXPERIMENTS. BEYOND THE RANGE NOW USED IN TELEPHONY AND RADIO IS A REGION OF EXTREMELY HIGH FREQUENCIES NOW BEING INVESTIGATED WITH A VIEW TO FUTURE USEFULNESS IN COMMUNICATION SYSTEMS.

messages can be sent at the same time over the same wire, much as many radio broadcasting programs are carried simultaneously by the ether. At the receiving end these messages can be unscrambled and each one applied to its own telephone set by a procedure like that of tuning in a station with a radio receiving set. This



FIG. 14. AN AISLE OF A CENTRAL OFFICE IN A DIAL SWITCHING AREA
SHOWING COMPLEXITY OF MODERN TELEPHONY.

method is shown schematically in Fig. 9, which pictures the arrangement now used on open wire telephone lines.

With this system one wire carries in addition to the ordinary telephone message at voice frequencies of from 200 to 3,000 vibrations per second two carrier telephone groups which cover the range from 6,000 to 140,000 vibrations per second. There is no fundamental difference in behavior between the two carrier groups. Type C was developed first and carries three messages. Later it was found that the J type circuits with twelve additional messages could be added by using higher frequencies. Sixteen telephone conversations and two telegraph messages can be carried thus over a single pair of wires. Each telephone has its own modulator M to combine the outgoing message with its high frequency carrier current and a demodulator D to separate the incoming message from its carrier. The message for each telephone is segregated from the rest by electrical filters F. Many transcontinental circuits are now operated on this principle. There is a practical limit, however, to the number of messages that an ordinary telephone line can be made to carry because the crosstalk into other pairs of wires strung on the same pole line becomes too great as higher and higher frequencies are used to carry more messages.

COAXIAL CABLE

At this stage transmission engineers again came to the rescue by devising the coaxial cable shown in Fig. 10. Instead of having two wires like an ordinary telephone circuit, this one has a central wire surrounded by a metal tube. The central wire is supported on insulating discs. Conductors of this type will carry frequencies of several million vibrations per second without crosstalking into each other and thus a whole new range of

carrier currents became available for carrying telephone messages.

An experimental coaxial cable recently installed between New York and Philadelphia will carry 240 telephone messages simultaneously and uses frequencies up to over a million cycles per second. This is accomplished by using 240 carrier currents which occupy a range in frequency from 60,000 to 1,020,000 vibrations per second. The arrangement is shown schematically in Fig. 11. A separate coaxial conductor is used for sending and receiving and repeater amplifiers especially designed to carry high frequencies are located at intervals along the lines to restore the attenuated currents. In more recent experiments it has been possible to increase the frequencies to 2,000,000 vibrations per second and send 480 messages over this cable. The first commercial installation of coaxial cable is now operating between Stevens Point, Wisconsin, and Minneapolis, Minnesota, a distance of about 200 miles. This cable is capable of

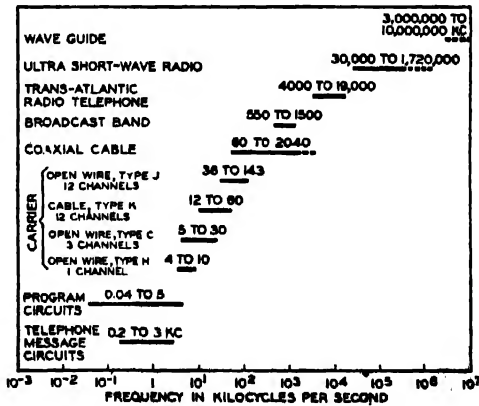

FIG. 13. GAMUT OF FREQUENCIES NOW USED OR BEING INVESTIGATED FOR COMMUNICATION SYSTEMS EXTENDS FROM TWO HUNDRED TO THREE BILLION VIBRATIONS PER SECOND. THIS RANGE INCLUDES THE VOICE FREQUENCY OF LOCAL TELEPHONE CIRCUITS, HIGH FREQUENCY CARRIER CURRENTS USED IN LONG DISTANT TELEPHONY, AND THE STILL MORE RAPID VIBRATIONS OF RADIO COMMUNICATION.

carrying 480 messages. Coaxial cables can also carry television signals.

ULTRA-HIGH FREQUENCIES

Beyond the frequency range now used on coaxial cables there is a region of still higher frequencies, extending from three to ten billion cycles per second, which is now being investigated. Brass tubes, illustrated in Fig. 12, are used to transmit these enormously high frequencies. As yet this region is entirely experimental, but the trend toward the use of higher frequencies in telephone communication has recently been so marked that these new explorations may soon find application in practical telephony. The gamut of frequencies now used or being

investigated for communication systems is shown in Fig. 13.

In this brief outline only a few of the high-lights in the history of telephony have been noted, but these may serve to emphasize some of the great advances which have been made in telephone apparatus and methods since the first feeble messages were sent by Alexander Graham Bell over a two-mile span between Boston and Cambridgeport, Massachusetts, sixty years ago; and there is every reason to assume that further improvements will be made, for research and development engineers are continuously striving to perfect and extend our facilities for projecting the human voice instantaneously over great distances.

GENERAL EDUCATION AND SOCIAL PROBLEMS

SINCE its beginning in 1933 there has been considerable development in the conception of the purposes and scope of the Board's program in general education. At that time it was thought of as largely internal to formal education. That is, the Board's work was to be limited almost entirely to aid to study and experimentation with the academic curricula of the secondary school and the junior division of the college. Vocational education was definitely ruled out. True, the Board expected the American Youth Commission to consider the broad problem of the care and education of youth and to make general recommendations; but it was supposed that most of the projects aided by the Board would fall within the sphere of curriculum experimentation, and the development of new instructional materials and methods suited to the changing social scene and the changing secondary school population. It was tacitly assumed that the economic depression of 1929-1933 would soon be over, and thus there was no need for concern with the problems of youth employment.

But as the American Youth Commission and other organizations pursued their studies, it became evident that their task was more complex than had at first been imagined. Instead of

restricting themselves to formal education, these groups found it necessary to consider the entire problem of the care and education of youth. Education was still the focus of attention, but the focus was widened to take in the social scene that gave rise to the need for a reorganized general education. It became clear that the task of these organizations was to help make America's provision for the care and education of youth keep step with the major social changes in which the country was engaged. Not the ideas of educational theorists about the nature of general education, but the hard facts of population trends, youth employment and government fiscal policy became the landmarks for charting the course. When it became clear that getting and keeping a job was the major problem of youth, the General Education Board indicated an interest in the field of vocational education by supporting projects dealing with the occupational adjustment of youth. When it seemed probable that the government would have to provide work or scholarships for large numbers of young people for ten years or more, the Board supported studies and experiments in connection with the government youth services.—*Annual Report of the General Education Board, 1940.*

THE AGING PROCESS AND TISSUE RESISTANCE¹

By Dr. WM. deB. MacNIDER

KENAN RESEARCH PROFESSOR OF PHARMACOLOGY, MEDICAL SCHOOL OF THE
UNIVERSITY OF NORTH CAROLINA

IN connection with this discussion the observation is made to the effect that many biological scientists and physicians have been and are interested in embryonic life, the life of infancy and childhood and that changing and adjusting life of puberty, and yet relatively few individuals have shown the same degree of interest in the changing life of the middle-aged as it advances into senility, and finally to a senile and perhaps physiological death. It is appropriate as a contradiction to make this statement at Ann Arbor, as one feels the great, living influence of Warthin,² who through his monograph on "Old Age" not only made scientific and philosophical contributions of lasting worth, but stimulated interest to be expressed by research in this domain of biology as it touches all living creatures. Such an interest culminating in an understanding of the physical and chemical changes associated with the aging process is of more importance and offers greater difficulties than an understanding of similar changes in infancy and in childhood. In these age periods the life urge is for the normal and towards survival, while with later age periods the tendency is the reverse. The processes responsible for physiological life are on the wane. The time has come for chemical changes leading to degeneration and retrogression to supervene and slow down cell life until it closes.

¹ The second of a series of three articles on "Tissue Susceptibility and Resistance" contributed by the author.

² Alfred Scott Warthin, "Old Age." Paul B. Hober, Inc., 1929.

An interest in the aging process is at least two-fold. Of fundamental biochemical importance is an understanding of what constitutes aging. What are the chemical differences developing with aging which tend to differentiate it from youth? If we know the significant facts in this domain of life we would also know something of a chemical nature which characterizes physiological life. Infancy and youth, the aged and the senile, represent chemical equations in a progressive adventure from life into death. From an applied point of view such understanding is of great importance. This order of knowledge would not necessarily prolong the senile state as such; perhaps this is not advisable, but it would very likely indicate how degenerative changes in tissues assumed to be normal for the aging individual could be modified or deferred, allowing the individual to live longer in this period of his life span in a more effective and happier fashion. It does not with fine sentiment assume "The best is yet to be, the last of life for which the first was made." It does something about it and in the doing may give life and joy to the fine lines of Browning.

As is so frequently the case in experimental work, one's interest becomes deflected away from the major emphasis of a planned experiment by some observation which at first would appear of incidental importance.³ Many years ago experiments were undertaken in my laboratory in an attempt to explain various changes in urine formation when the kid-

³ Wm. deB. MacNider, *Jour. Pharm. and Exp. Therap.*, 4: 491, 1913.

neys were injured by a variety of chemical substances such as cantharidin, potassium dichromate, uranium nitrate and bichloride of mercury.^{4, 5, 6} The physiological aspects of these experiments had to be done under the influence of a general anesthetic. The two generally employed substances for this purpose at this time were chloroform or ether. Very early in these experiments the observation was made that in so far as kidney function was concerned, chloroform exerted a much more inhibitory influence than ether. Not infrequently the use of chloroform as an anesthetic for from four to ten minutes would permanently arrest urine formation, while a similar influence from ether, when administered over a much longer period to dogs with an acute uranium nephritis, would only result in a reduction in urine formation. A further analysis of the toxic action of these general anesthetics for the kidney, established definitely that the degree of action was associated with the age of the animal.⁷ A large percentage of the adult dogs, and with few exceptions those animals over eight years of age, became anuric when chloroform was used. In puppies, animals of seven months and younger, this influence was less marked or failed to occur. The age factor expressed itself when ether was employed by only certain of the older and senile animals showing an inhibition in urine formation. As a result of these observations it became necessary to analyze the data obtained in the animals of different age groups from the use of uranium as a renal poison before the employment of an anesthetic. This analysis indicated not only an increase in the susceptibility of the kidney in a structural sense to the action of

uranium as these animals advanced in their life spans, but indicated changes of a quantitative metabolic order in the animals which were associated with the same factor. The puppies and young dogs showed only slight evidence of the toxic action of this chemical when given in the amount of two milligrams per kilogram, while the same dosage of the substance in adult and in senile animals, regardless of the weight of the animal, gave evidence of an intensification of not only the local renal influence, but of the generalized metabolic disturbance. The earliest of these changes consisted in the animals developing a glycosuria with the appearance of ketone bodies in the urine. Within six to ten hours there occurred a reduction in the reserve alkali of the blood. This is not a retention phenomenon due to a renal injury. It develops usually before the appearance of albumin in the urine and at a time when the elimination of phenolsulphonaphthalein by the kidney is of a normal percentage. There is no retention of urea or non-protein nitrogen.

The explanation of the local toxic action of uranium for the kidney of animals of different age periods, as well as that of the more generalized tissue influence, is hypothetical. The influence of age is the determining factor for the degree of local injury and quantitatively for the influence of the chemical on metabolism. We may be permitted to assume that these changes are due to uranium inhibiting processes of oxidation. The degree of inhibition as evidenced quantitatively by the changes in the blood and urine become more marked as the animals advance in years and reach their height in certain of the animals as senility develops. The same order of disturbance may be obtained in young adult dogs and in puppies. Such changes are delayed in their appearance, are less marked and not infrequently in this group of young animals there occurs

⁴ *Idem, Jour. Med. Research*, 21: 79, 1912.

⁵ *Idem, Jour. Med. Research*, 23: 403, 1913.

⁶ *Idem, Proc. Soc. Exp. Biol. and Med.*, 11: 159, 1914.

⁷ *Idem, Jour. Pharm. and Exp. Therap.*, 17: 289, 1921.

no change in one of the fundamental equilibria of the organism, the acid-base balance of the blood. Just the reverse status is found to occur, especially in the senile animals, and also in normal animals under the strain of pregnancy.⁸ Such normal animals, even in advanced senility, have the ability to maintain this balance, but when placed under a strain to maintain it, either by the use of uranium or a general anesthetic, its instability is shown by the rate and the degree to which the reserve alkali is depleted.

From the kidney and the liver of these animals of different age groups biopsy material was obtained to investigate the type of change developing in these organs as influenced by the age factor. Such tissue from the kidneys of puppies shows but slight histological evidence of injury. There is no evidence of glomerular injury. The amount of stainable lipid material in the ascending limb of Henle's loop in which location of the tubule such material is normally present, is increased in amount appearing as fused, coarse granules. The proximal convoluted segment of the tubule, on account of the selective action of uranium in this location gives more evidence of injury. Small amounts of lipid material can be demonstrated in these cells. It does not occur here normally. The epithelium shows cloudy swelling, the cytoplasm is granular and rarely vacuolated. The nuclei of such cells usually stain in a normal manner. In the adult, aged and certain of the senile dogs these histological changes are intensified. The two most conspicuous changes are the increase in the amount of stainable lipid material in the epithelium and the ability of such cells to take up and bind water with the development of a marked degree of vacuolation. The question again arises for the localized cellular changes in the kidney as expressed quantitatively through the age

factor if they may not be due to uranium inhibiting changes of oxidation within such cells, the effect of the inhibition having a greater physical expression in the cells of aged animals than in young animals and puppies. These experiments have been recounted in order to indicate that aging as such, whatever this may compositely mean, may so influence an organism as a whole, and specifically one or more organs of such an animal as to greatly modify quantitatively the action of a chemical of known composition. There is no reason not to consider that the utilization of food materials may be subjected to similar influences dependent basically on the age of an animal and that the same type of reasoning should not be applied to the value of the various vitamins in such age periods. It may well be that certain of the tissue degenerations of the middle-aged are due to a combination in a state of imbalance of these two factors.

The histological studies which have been discussed were employed in an attempt to explain the increasing toxic effect of both chloroform and ether for the kidneys of dogs rendered acutely nephritic by uranium as such animals advanced in their life span. These studies indicate that other than the usual changes of degeneration which injurious chemical substances induce in the kidney, the characteristic change which is quantitatively associated with the aging process is the amount of stainable lipid material in terms of an increase which makes its appearance in the epithelium following a uranium intoxication. The presence of this substance in a fashion sensitizes the epithelial tissue of the kidney for the toxic effect of these general anesthetics. Its presence is likely the chemical factor which enables the kidney of the animals as they advance in age to bind such an amount of the anesthetic body that it expresses itself structurally by both an increase in the amount of stainable lipid and by

⁸ *Idem, Jour. Exp. Med.*, 43: 53, 1926.

the development of an acute necrosis of the cells of the convoluted tubules. There is no evidence of structural alteration in the glomeruli other than an increase in lipid material. In the light of these observations the question arose as to whether or not the toxicity of these two general anesthetics for the kidney might not be influenced by employing agents prior to the anesthesia which would lessen the amount of stainable lipid material in the kidney and in this manner decrease the amount of the anesthetic body which would be taken up, transitorily bound by such tissue and enabled to manifest its toxic effect by renal epithelial degeneration. For this purpose two different substances have been employed; a solution of sodium carbonate equimolecular with 2 per cent. sodium chloride, or a 20 per cent. solution of glucose, the usability of which was facilitated by employing insulin subcutaneously. For purposes of control, animals of the same age periods as those receiving either the sodium carbonate solution or the glucose were given a 0.9 per cent. solution of sodium chloride. Six hours after the use of such solutions biopsy material was obtained from the kidneys of the animals in order to ascertain by microchemical methods the amount and distribution of stainable lipid material in this tissue from animals of different age periods that had been rendered acutely nephritic by uranium. In the control group of animals the use of sodium chloride solution had no effect in modifying the amount of stainable lipid material developing in the kidney of the animals of the different age groups from the use of uranium. It failed to give the kidney any protection against the subsequent use of the general anesthetics. The use of glucose with insulin was variable in its effect. In the young adult animals it not only manifested its diuretic action, but in such animals its

use led to an apparent decrease in the amount of stainable lipid, especially that which develops in the convoluted tubules. Such animals were afforded a degree of protection against the use of ether as an anesthetic but no definite protection against chloroform. The most definite evidence of renal epithelial protection was obtained when a solution of sodium carbonate was used before the period of anesthesia. Such a solution when given to puppies and young adult animals so changes the chemical constitution of stainable lipid material in such cells that it fails to give the characteristic staining reaction with Scharlach R. This is true to a less extent for animals over eight years in age so that when dogs in these different age groups are anesthetized by ether all are found to remain diuretic and responsive to diuretic substances. When chloroform is employed there is less evidence of protection for the older animals. They do not become anuric, as is invariably the case when they are anesthetized with chloroform without the protection from the carbonate. In general the use of this substance in adult animals, and in a certain proportion of the old and senile animals, translates them in so far as their renal toxic response to the anesthetic is concerned to the status of much younger animals.

In an earlier part of this discussion the statement was made that certain of the senile animals failed to show an accumulation of lipid material in renal tissue, especially in the epithelium following the use of uranium nitrate. Such cells in animals of this age period were refractory to this chemical influence. Associated with this difference in the pathological chemical constitution of such cells, this tissue failed to show evidence of rapid injury characterized by necrosis from the use of the general anesthetics. This observation would strengthen the inference which has been

made that the presence of such material is the chemical factor which determines the affinity of the anesthetic for renal tissue, in turn determines its concentration, and through this concentration enables the anesthetic body to induce changes of degeneration. The morphology of the epithelium in the proximal segment of the convoluted tubule of these senile animals which show an absence of stainable lipoid material, following the use of uranium, and which resists the toxic action of the anesthetic substances, is not of a normal order. The cells lining such tubules are atypical, flattened structures, or the lining is of a syncytial nature resembling in structural configuration the type of cell described in the first lecture as developing in the liver or the kidney⁹ from the use of uranium and which imparted to such epithelium an acquired resistance against not only uranium, but to other chemical substances of a very different order. For the senile animals under discussion the acquisition of this atypical type of cell was not brought about by any experimental procedure in which a chemical body was employed to injure cells and lead to a process of repair. Whether or not this change in cell type arose as a repair process, the result of intercurrent renal disease of an unknown nature, or whether in a certain percentage of aging animals this change develops as a structural part of the aging process is not known.

For a number of years routine histological studies have been made by obtaining biopsy material or material at autopsy from both the liver and the kidney of dogs over five years of age that have come through the laboratory for either experimental or routine teaching purposes. Such tissues from one hundred and eleven animals falling in this advancing age category have been available for study. Of this number the

⁹ *Idem, Jour. Exp. Med.*, 49: 411, 1929.

livers of eighteen of the animals have shown the type of changed epithelium which has been described for the kidney of these and of other animals. Fourteen of these aged animals which have shown this naturally acquired shift in the epithelial structure of the liver have been starved for twenty-four hours and then given chloroform by inhalation for three hours without the development of a central necrosis of the liver lobules. At a later period, when the same animals were starved for forty-eight hours and given chloroform on two successive days, evidence of injury as a partial necrosis developed in this location of the lobules. Such results are in striking contrast to those recounted in the previous lecture in which, after a period of starvation, this anesthetic was administered to dogs with a normal epithelial structure, but resembles the results obtained when chloroform was given to animals which had been intoxicated by uranium and had repaired the liver injury by the formation of an atypical and resistant type of epithelial tissue.¹⁰

SUMMARY

1. The observations which have been presented in this discussion indicate that the quantitative response of an animal organism to the influence of a chemical substance may in large measure be determined by the age of the organism, and furthermore, that this factor of age may show itself in a structural manner by either facilitating or in part preventing changes of a degenerative nature from developing in such tissues.

2. An attempt, or perhaps better, a suggestion has been offered without adequate and substantiating proof to explain these generalized and localized differences in the action of one substance, uranium nitrate. The explanation concerns itself with the quantita-

¹⁰ *Idem, Jour. Pharm. and Exp. Therap.*, 56: 383, 1936.

tive ability of this substance to inhibit processes of cellular oxidation. This action would vary in animals of different age periods. As the animals advance in their life span this evidence of an inhibition of tissue oxidations increases, as is shown by the degree of glycosuria, the extent to which ketone bodies are formed, and appear in the blood and urine, and finally by the ease and degree to which a reduction in the reserve alkali of the blood may be obtained.

This concept of an inhibition of intracellular processes of oxidation by uranium nitrate would assume that as the animal ages these intracellular life processes diminish so that in an aged or senile animal the same degree of oxidative inhibition induced by uranium nitrate would have a more marked chemical expression than it would have in a younger animal in which these processes for life take place in a more abundant manner and in a more completed manner.

The significant localized cellular changes of a histological order which occur during such a process of oxidative inhibition are shown by the accumulation of stainable lipid material in the epithelial tissue of the liver and kidney and by an increased binding power of such tissue for water. Associated with the degree to which stainable lipid material accumulates in such cells there exists a definite relationship with the ability of two other chemical substances, ether and chloroform, to exert their local toxic effect for these organs. There is no reason not to suppose that these anesthetic bodies may exert not a toxic action, as expressed by degeneration, but an anesthetic influence on these structures when they become sensitized for this action by lipid accumulation. In puppies or in young adult animals in which the use of uranium leads to the least accumulation of this substance, the anesthetics have their minimum toxic

effect, while, as the animals advance in age, with an increase in such intracellular material, the same anesthetics not only acquire the ability to arrest function as anesthesia, but demonstrate an exaggeration in their ability to induce structural changes of a degenerative order.

These studies have furthermore shown that the use of an alkali which indicates its intracellular influence at least in one gross manner, by changing the staining reaction of lipid material, has associated with such a modification of this material the ability to afford protection to both renal and hepatic tissue against the toxic action of ether and chloroform. Finally, associated with the aging process there may develop in certain senile animals a change in the morphology of hepatic epithelium from that of a polygonal type of cell to one of a flattened order which fails to show the presence of stainable lipid material. Such cells are resistant, not only to uranium, but to ether and chloroform.

3. These investigations have demonstrated that not only may cell morphology change as animals age, but that with or without such changes the chemical nature of the cell may vary. Chemical reactions within an organism may be modified by processes natural for the animal as well as by the introduction of chemical substances not of a natural order for such tissues. These observations tend to lead one away from a consideration of form as such, and to stimulate an understanding of the chemical nature of form as influenced by aging. In the future this type of investigation may furnish for the aging and the senile individual a competent group of applied biological scientists as physicians who will attempt through their understanding to in part prevent or delay tissue degenerations now considered normal for the aged, and enable individuals in these advancing age groups to live more effective, more related and happier lives.

PHYSICAL THERAPY

By Dr. RICHARD KOVÁCS

NEW YORK, N. Y.

THE story of the gradual evolution of the therapeutic employment of physical forces of nature makes fascinating reading. In many instances the genius of one keen observer—not necessarily a physician—recognized the beneficial effects of such procedures as water treatment, electricity in some form, sunlight or a certain manipulation or exercise. In enthusiastic hands, at first the healing virtues of such a new method are magnified, while failures are disregarded and the method often “runs wild.” The medical profession, being conservative as a whole, wants proof of success obtained under its scrutinizing observation; for this reason only such measures become adopted that have stood extensive trial in critical hands.

A spectacular development in the treatment of disease and injury by physical methods has come about only during the past twenty-five years in the United States. Up to the time of the first World War the few medical men actively practicing physical therapy were looked upon by the majority of their colleagues with suspicion, mingled with pity. Scattered groups of enthusiasts practiced electrotherapy in one corner, hydrotherapy in another, and manipulation and massage in still another corner. There were no physical therapy departments in hospitals where the different physical methods could be correlated. Clinical and laboratory research could not be done, and the scrutinizing eye of the medical profession could not keep an institutional check on the results with these new methods of the healing art.

A change for the better came when, as a result of the World War, thousands of disabled men had to be put back into a

state of comfort and functional activity. It became recognized, chiefly through information imported from abroad, that well-equipped and conducted physical therapy departments are indispensable for this purpose, as adjuncts to orthodox medicine and surgery. Concurrently, development of many new and highly effective methods of physical treatment, such as diathermy, and artificial ultraviolet radiation took place. Within a few years there became available a large body of technicians trained in physical therapy and a good number of medical men capable of practicing it. But above all, the majority of medical men became convinced that the practice of physical therapy must become part of the standard practice of medicine.

Dean Torald Sollmann, professor of pharmacology of the School of Medicine of Western Reserve University, stated recently:

... although drug therapy and drugless therapy may seem direct antipodes to the superficial thinker, they involve the same principles, evoke the same phenomena, accomplish the same results. They differ only in the means which they employ, of which sometimes the one, sometimes the other is better adapted to secure the desired end. Indeed, the differences between physical therapy and pharmaco-chemical therapy are no greater than those between radiant and direct heat, or between local and general anesthetics.

Drug therapy employs medicinal remedies which are administered through the stomach or intestines or by inhalation or by injection under the skin or in a vein; these remedies exert a therapeutic effect by stimulating or depressing certain functions of the body. Physical therapy generally employs remedial agents which primarily affect the skin

and the underlying soft tissues and in turn act on local or general circulation, on the nervous system or on other body organs or systems; at other times physical therapy consists in employing the body's own vital forces as in the form of regulated exercise. The obvious advantages of physical measures are that they usually can be directly applied to the affected part and often give immediate relief in acute conditions. In chronic conditions patient and systematic application is essential, but there is no danger of habit forming as in the case of the use of certain drugs.

THERMOTHERAPY

Heat is the most frequently used and most versatile among physical treatment forces. Since the beginning of man's history hot springs were the meccas of sufferers from rheumatic and other disabling conditions. Modern technical progress has placed at the disposal of physicians and the laity a bewildering number of thermal measures. Conductive heat is supplied by hot-water bottles, electric and other heating pads, hot compresses, hot-water and hot-paraffin baths, but the penetrating effect is very limited; with surface heating which can be safely tolerated, the deep-lying tissues dissipate heat at a faster rate than it can be conducted to them. Radiant heat is applied by heat lamps, consisting of incandescent lamps placed in a reflector and non-luminous heating elements, warmed up to just a dull red heat; the high temperature radiation from heat lamps penetrates deeply through skin layers and even into the subcutaneous fat and muscles, while the low temperature glow heat is all absorbed in the superficial layer of the skin. Convulsive heating consists of a passage of a large amount of a high frequency electrical current deeply through the tissues, as will be discussed later on under diathermy.

The various forms of therapeutic

heating are employed either to part of the body or to the body as a whole. The immediate effect of any form of heating is a rise of temperature in the body tissues; in relation to the degree and extent of heating there follows as a reaction by the heat-regulating mechanism of the body an increase of circulation and with this an increased local metabolism. This is most useful in assisting nature in the resorption of products of injury and inflammatory reaction. It also aids the forces of defense against infection by increasing the activity of the white blood corpuscles and increasing local immunity of tissues. The most important heat-sensitive organism, the gonococcus, can be directly killed in the tissues of the body by a temperature of 106.7° F. which is within physiological tolerance of the tissues, provided that this temperature is maintained at the thermal death time varying from six to twenty hours according to the particular strain of gonococcus. Mild heating on the other hand is also one of the oldest means to relieve irritation of sensory nerves—pain, and of motor nerves—spasms and cramps. The most likely explanation of the pain-relieving effect is an inhibition through the temperature nerves of the skin.

Therapeutic heating locally applied is one of the most frequently used measures in treatment of traumatic, inflammatory and rheumatic affections. It is evident that in any case the type and extent of heating must be skilfully selected and directed. When there is heat there may be burns; there is no entirely safe form of therapeutic heating. Artificial fever has been found effective in a variety of conditions resistant to routine medical treatment, among them advanced forms of organic nervous diseases, such as general paralysis of the insane and locomotor ataxia, gonorrhoeal arthritis and gonorrhoeal inflammations of the female and male organs, chorea minor and certain forms of bronchial asthma.

LIGHT THERAPY

Sunlight represents a blending of infrared, luminous and ultraviolet radiation. In the average sunlight there is about 60 per cent. infrared or heat radiation and 40 per cent. visible and ultraviolet radiation; all these from a physical standpoint represent electromagnetic radiations of different wave-lengths. The ultraviolet part of sunlight has received considerable attention in recent years, but it must not be forgotten that if the heat rays of the sun were screened off the earth, it would be surrounded by an ice crust in short order; and if it should cease to send the green portion of the visible spectrum, which is responsible for the formation of chlorophyll—all-important for vegetable life—all life on earth would become extinct.

Ultraviolet radiation by itself exerts chemical effects on the skin, resulting in the activation of vitamin D, which in turn influences calcium and phosphorus metabolism and acts as a preventive of rickets and other calcium deficiency conditions; it also makes general metabolism more efficient, causing the organism to operate with increased economy; there seems to exist also a stimulating effect on the endocrine glands. The effects of sunlight and its artificial substitutes in the form of mercury vapor and carbon arc lamps for improving appetite and sleep, increasing assimilation and metabolism are extensively utilized in therapeutics.

The bactericidal effects of ultraviolet radiation on germ life have been recently employed for "air sterilization" in keeping the bacterial contents of operating rooms and children's wards at a minimum. In the tissues of the human body bactericidal effects are limited to the uppermost layers of the skin because ultraviolet penetrates only to a depth of two millimeters. However, in treatment of sluggish and infected wounds and some skin infections, such as ery-

sipelas, ultraviolet rays, especially when combined with heat radiation, are quite effective.

The curative effects of heliotherapy on tuberculosis of the bones, joints and lymph glands and other forms of "surgical" tuberculosis are without a generally accepted explanation. The rest, climate, general hygiene in heliotherapy establishments undoubtedly also play an important role, as proven by the fact that simple lamp treatment can not duplicate the results. Self-prescribed and self-administered ultraviolet lamp treatments as fostered by commercial interests carry with them dangers of over-exposure and of careless handling.

ELECTROTHERAPY

Electricity for treatment is employed in the form of electromedical currents such as the galvanic, faradic, sinusoidal and high frequency, which are practically all derived from the commercial lighting current by changing it by a variety of devices. According to their strength, volume and frequency these currents affect body tissues on the surface or interior of the body. All effects of electricity can be satisfactorily explained on the basis of physics, chemistry and physiology.

The oldest form of therapeutic current is the galvanic, which corresponds with the commercial "direct" current. When applied to the body this current exerts mild stimulation through chemical action: an acid effect by the positive pole and an alkaline by the negative pole. Medical ionization by the galvanic current is based on the elementary law of electro-physics, that bodies with unlike electric charge attract each other while those with like charges repel each other; consequently, medicinal substances can be introduced in "ionic" state into the skin or mucous membranes from a pole of opposite electric charge. Such treatment is being employed in treating

chronic inflammation in the ear, nose, genital tract with copper and zinc ionization and in treating some forms of arthritis and rheumatic conditions, and sluggish ulcers with vasodilating drugs which beneficially affects local blood circulation. Treatment of superfluous hair by destroying its roots by a needle charged with a galvanic current is popularly known as electrolysis.

If the galvanic current is employed instead of a steady flow in the form of a sudden interruption, the impact of electric ions causes stimulation of nerves and muscles. There exists a physiological time-intensity relation of electrical stimuli: in order to produce a contraction by ionic changes a current must have a certain minimal strength as well as a certain minimal duration. In electrotherapy the term of low frequency, or contractile currents, embraces all currents used for stimulation of muscles. When the existing muscle power can not be employed for voluntary exercise, or when the muscles are fully paralyzed, the problem is to maintain a minimum of muscle function until normal nerve impulse returns. Electrical muscle stimulation in skilled hands is valuable in after-treatment of injuries resulting in simple muscle weakness as well as in the long dreary months of recovery after a nerve injury or in infantile paralysis.

In the new method of electric shock therapy a low frequency current is applied through the brain; the mild shock to the nerve centers acts favorably in such mental disorders as schizophrenia. This development, replacing the more risky shock treatment by drugs with one controllable physical means, is similar to the introduction of electric fever in treatment of progressive paralysis and other disorders, replacing the more dangerous fever produced by malarial inoculation.

The most widespread use of electricity in treatment nowadays occurs in the form of high frequency currents. With

electric currents consisting of electrical oscillations of several millions per second, produced by spark gap or radio tube apparatus, because of the extremely short duration of each single impulse there occurs no ionic movement. Consequently, high frequency currents do not excite muscle and nerve tissue; their oscillating energy is simply transformed into heat energy along the path of the current which can be employed at a much higher volume because of the absence of any shock. Medical diathermy denotes the use of a high frequency current for through and through heating of human tissues, while surgical diathermy or electrosurgery denotes the drying or destruction of diseased tissue or new growths on the surface or interior of the body by a suitable operative technic.

Two forms of medical diathermy have been developed; oscillations of about one million frequency are employed with metal electrodes directly applied to the skin and are known as long-wave diathermy; while oscillations of a frequency of ten millions or more can be employed with the electrodes an inch or more apart from the skin and are known as short-wave diathermy. There is no particular difference between the clinical effects of long- and short-wave diathermy, notwithstanding some enthusiastic assertions of the protagonists of the newer method of short-wave diathermy. Both act primarily as tissue-warming agents and are principally useful in deep-seated chronic inflammatory conditions of joints, bones and inner organs, when used in conjunction with other indicated medical routine. Short-wave diathermy can be more easily employed in acute sinus inflammation and pus infections of the skin because of avoidance of skin contact by the electrodes. On the other hand, in such conditions mild doses of radiant heating appear equally useful and much simpler. The dosage of diathermy and consequently the rise of temperature in

the deep tissues is largely guided by the operator's clinical experience and the patient's comfortable skin sensation; so-called dosimeters for short-wave diathermy have been constructed, but have found as yet no general clinical acceptance.

Electrosurgery by high frequency electricity has opened up a new vista in the surgery of such highly vascular organs as the brain, spleen; the instantaneous coagulation of the contents of numerous small blood vessels and capillaries under an electrically charged instrument enables operations with a minimum of bleeding and under perfect control. With these new developments medical electricity, once a much abused stepchild in therapeutics, has become now an agent of everyday use in physicians' offices and hospitals.

HYDROTHERAPY

Water in its employment as a physical therapeutic measure depends on its property as a medium for conveying of certain physical forces. Water has a great capacity for absorbing heat; and it can readily be applied with varying and regulated pressure. Hence the two main divisions of treatment of water are hydrothermal applications, in which the temperature effects of the water play the leading role, and hydrokinetic applications in which the mechanical effects of immersion, of the pressure and flow of water exert, in addition, certain specific effects. There occur also a limited amount of hydrochemical effects by the introduction of certain skin-stimulating substances.

Water applied to the body at a temperature different from that of the average skin surface—92° F.—either will conduct heat to the body or absorb heat from it. The difference in temperature acts as a "stimulus" or irritation of the nerve endings of the skin. The more intense the stimulus, the larger surface

of the skin it affects and the longer it lasts, the more intense will be the reaction caused by it. Tepid water, at a temperature of 92° to 94° F., causes no external stimulation of the skin nerves and therefore exerts a marked relaxing, nerve-resting effect upon the entire body. One can lie in such a bath for hours in perfect repose. Hence its time-honored application in the calming treatment of disturbed patients in mental hospitals, avoiding narcotic drugs or mechanical restraint.

A short cold application causes constriction of the blood vessels of the skin and of the muscular tissues underneath it, also a deep inhalation—the familiar gasping and other effects on the circulation—slowing of the pulse, increase of the tone of the heart muscle. This cold "reaction" is used in many general cold-water applications—ablutions, baths, showers—to stimulate the vital forces of the body. A cold compress applied to a small part of the body and frequently renewed serves for immediate relief in recent injuries as well as in early stages of inflammation, by combating swelling and pain by constriction of the blood vessels of the skin. Cold wet packs applied to the entire body are very effective in quieting restless, sleepless people, for after the initial cold reaction there occurs a dilation of the blood vessels of the skin and a relaxing effect of the warm vapor on the sensory nerve endings. The same effect explains the beneficial effect of so-called stimulating compresses which are cold compresses left on without change; they are locally helpful in acute congestive conditions of the throat, chest and abdomen. There exists a large variety of other forms of cold and hot applications, ablutions, sheet baths, partial baths, hip and sitz baths and contrast baths, all employed on the basis of definite physiological principles.

The paraffin bath is a newer form of

heat application consisting of immersing the hands or feet in melted paraffin, at an average temperature of 115° F. It offers a high degree of even surface heating and makes the skin soft and pliable, ready for subsequent massage or exercise. Such a combination treatment is especially effective in swelling and stiffness following injuries and infections. Carbon dioxide baths contain natural or artificial carbon dioxide gas administered in a bathtub with the water at a temperature of about 92° F. Such a bath causes a dilation of peripheral vessels of the skin and increases the output of the heart and the blood pressure; in skilled hands it is useful in chronic heart disease. These are just a few of the many other special forms of baths.

The hot whirlpool bath is nowadays the most extensively used hydromechanical measure. In it water at a temperature of about 110° F. is kept whirling by a motor or under its own pressure and thus exerts gentle friction to the skin in addition to the sustained heat; this is especially useful in relieving pain and stiffness after recent fractures and in circulatory disturbances of the extremities. Under-water exercise tanks and therapeutic pools make use of the old Archimedic principle that a body immersed in water is buoyed up by a force equal to the weight of the water it displaces; the elimination of the gravity effect enables muscles too weak to perform outside of water to be actively exercised; in addition, the heat of the water relaxes spastic muscles and improves circulation. This pool treatment opened up a new means for exercising weak muscles in infantile paralysis, also after injuries and in stiffness following arthritis. In outdoor pools the fresh air and sunshine add beneficial tonic effect on the entire body.

Colonic irrigations are used for mechanical cleansing purposes and have been brought to popular interest largely

by commercial propaganda. Some of these "colon filling" establishments cater to a misled group of colon "addicts." In competent hands there is, however, some real merit to colonic irrigation in certain obstructive and toxic conditions of the lower bowel; it is now so employed, under adequate medical supervision, in many institutions of standing.

Spas and health resorts make use of water for drinking, bathing and for some of the treatment procedures just described. The present world crisis with the continued inability of patients to go abroad offers a favorable opportunity to promote many of the fine resorts in the United States. The American Medical Association has recently appointed a Committee on Health Resorts. Among the many obstacles, however, in the way of a more general utilization of American resorts are the lack of spa-mindedness by American physicians, the lack of interest of most state and municipal authorities and subsequent dearth of suitable surroundings and development, the lack of competent medical direction in many places, in others the high cost of spa treatment. Many chronic conditions and convalescence could be treated advantageously in our spas to a much larger extent than heretofore.

MECHANOTHERAPY

Massage is one of the most simple and most useful forms of physical treatment, requiring only a pair of skilled hands directed by a trained brain. In massage the physical energy of the operator's hands is transmitted to the patient and there are a number of massage movements serving a variety of purposes. Gentle stroking is an almost instinctive motion to exert a sedative reflex effect for soothing of pain, while deep stroking in the direction of the venous and lymph circulations relieves engorged veins after injuries and promotes resorption of chronic inflammatory swellings. Com-

pression, kneading, hacking and tapping are effective in the most frequent object of local massage, of toning up muscles and freeing adherent parts; they exert a varying extent of mechanical stimulation of the skin, muscles and nerves. In stiffness and swelling, following injuries and rheumatic conditions, intelligent massage preceded by suitable heating is most beneficial. In convalescence and in many chronic disease conditions general massage helps to maintain the general well-being, muscle tone, appetite and sleep. There is much false propaganda about the value of massage in obesity. No amount of violent massage can break up or reduce it "in spots." Likewise "rubbing" by a husky bath attendant has very little relation to scientific massage, and the effectiveness of massage treatment depends by no means on the amount of physical effort expended.

Exercise or gymnastics imply the employment of one's own vital forces in contrast to massage and manipulation which utilize the energy of another person. Exercises administered for curative purposes are of two kinds: general exercises to improve the function of the entire body and its organs, or local exercises to improve the function of one part—such as a joint or a tendon. Occupational therapy is closely associated with physical therapy; it is based on the principle that, whenever possible, putting the patient to work at some interesting occupation is much more beneficial than if left to himself to do routine exercises.

Physical treatment methods are applicable in all departments of medicine and are finding employment nowadays by general practitioners and specialists alike. Physical therapy technicians, lay operators and cultists of all shades are also eager to exploit the newly awakened interest of the public. However, in order to derive the best results from any form of apparatus or from bathing or exercising, more is needed than the mere knowledge of how to turn on a switch or go through certain movements. Any physical measure to be applied must be based, first, on a correct diagnosis, implying a definite conception of the existing pathological and functional departures of the body from its normal state in health; secondly, there should be no doubt as to what physiological responses to expect from physical treatment and thirdly there must be a full knowledge of just how that treatment is to be rendered, and finally seasoned experience is needed how to choose among the variety of treatments and to judge the body's reactions thereto. Physical treatment must be as carefully prescribed and administered as any medicinal treatment, for any physical measure that is powerful enough to do good is just as likely to do harm if incorrectly applied. There can be no doubt nowadays that in competent hands in acute diseases physical treatment serves as a valuable aid to recovery, while in chronic disease it acts as the most important reliever of pain and often offers the only chance of restoration and a return to useful life.

OPTIMUM AGES FOR EMINENT LEADERSHIP

By Dr. HARVEY C. LEHMAN

PROFESSOR OF PSYCHOLOGY, OHIO UNIVERSITY

WHAT are the optimum ages for attaining outstanding leadership? What are the chronological ages at which leaders are most likely to reach the high points in their careers? Fruitful investigation of this topic entails the collection of data for specific types of leadership. Moreover, the findings will need to be expressed numerically. With these two facts in mind the writer has sought to ascertain: (1) The chronological ages at which men have most often attained recognized or nominal leadership in several fairly specific kinds of endeavor, and (2) the chronological ages during which such leadership has been most frequently exercised or retained. Although it would probably be futile to attempt to evaluate the services of the leaders within each of the age groups, it is nevertheless possible to determine the relative frequency with which members of the various age groups have acquired and exercised various types of nominal leadership.

In some instances the leader probably determines in large measure what his followers shall think and how they shall act. In other instances the "leader" may resemble the small boy who marches in front of a brass band, and who maintains his position of "leadership" merely by anticipating correctly the direction that the band will next take whether or not he continues to "lead." For example, it seems obvious that some political leaders follow, rather than mold, public opinion. It is probably true also that in some instances the nominal leader is not the real leader but merely the tool or the "front" of one or more schemers or pressure groups. Since the present

writer knows of no satisfactory method for measuring the extent to which a leader has exercised genuine, in contrast to merely nominal, leadership no attempt has been made in this study to distinguish between these two kinds of leadership except in the case of military and naval leaders.

In practically all cases of nominal leadership the leader is chosen in recognition of his *previous achievement*; hence even without such data as will be presented in this article it would be a logical deduction that the ages of leadership will tend to occur later than the ages of individual achievement. In former studies (1) the writer has attempted to ascertain the chronological ages at which outstanding contributions are made. In some cases the obtained ages doubtless lag slightly behind the ages of actual achievement (*e.g.*, the publication of medical discoveries must occur after the discoveries are made). In the present study there is almost certain to be a much greater lag between the time of exhibiting the ability to lead and the attainment of eminent leadership, since eminent leadership is likely to result from a general group recognition of the ability to lead.

There are of course other factors than the lag of recognition behind achievement that prevent youthful leadership. But the slowness with which ability is recognized should forestall the hasty conclusion that the ability to lead necessarily develops when or after eminent leadership has been attained. For example, in the case of some of the presidents of the United States, their outstanding achievement in handling men

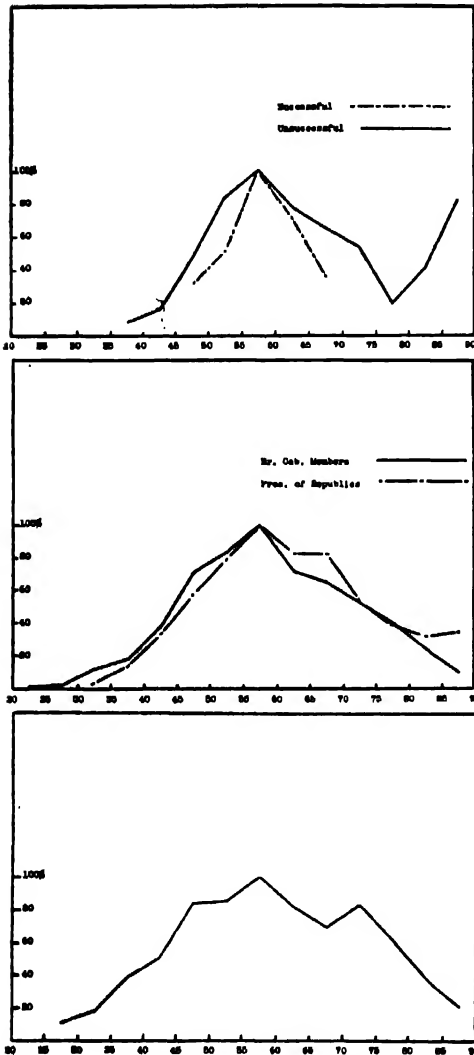

FIG. 1. AGES OF PRESIDENTS AND MINISTERS

Top: PRESIDENTIAL NOMINEES. (A) AGES AT WHICH 38 SUCCESSFUL PRESIDENTIAL CAMPAIGNS WERE MADE BY 27 DIFFERENT INDIVIDUALS, AND (B) AGES AT WHICH 108 UNSUCCESSFUL PRESIDENTIAL CAMPAIGNS WERE MADE BY 73 DIFFERENT INDIVIDUALS. *Middle:* (A) AGES AT WHICH 1,363 YEARS OF SERVICE WERE RENDERED BY 218 DECEASED MEMBERS OF BRITISH CABINETS, AND (B) THE AGES AT WHICH POLITICAL LEADERS SERVED AS PRESIDENTS OF THE VARIOUS REPUBLICS OF THE WORLD, OTHER THAN THE U.S.A., FROM APPROXIMATELY 1890 TO 1938, INCLUSIVE. *Bottom:* CHRONOLOGICAL AGES AT WHICH THE "CHIEF

and situations may have occurred *before* they held the presidency and may have been the crucial factor that enabled them to attain the presidency. A record of actual ability to lead would be very interesting, but difficult to obtain. In the pages that follow, nominal leadership of the following kinds will be discussed in order, namely:

- | | |
|------------------------------|-----------------|
| 1. Political or governmental | 5. Judicial |
| 2. Diplomatic | 6. Professional |
| 3. Military | 7. Religious |
| 4. Naval | 8. Educational |
| | 9. Business |

POLITICAL LEADERS

At what chronological ages are individuals most likely to reach the top of the political ladder? Fig. 1 (top) reveals the relative frequency with which men have been nominated for the presidency of the United States of America by the more important political parties. This figure is based on: (1) 38 successful presidential candidacies of 27 different nominees, and (2) 108 unsuccessful candidacies of 73 different nominees. In Fig. 1 (top) the broken line presents data for all successful candidacies down to and including the second term of Franklin D. Roosevelt, no distinction being made in this graph between first elections and second elections. The solid line of Fig. 1 (top) presents analogous information regarding the unsuccessful candidacies.

The reader should bear in mind that Fig. 1 (top) refers not to individuals but to the individuals' presidential candidacies. Obviously, the same man may have been a successful candidate in one or more elections but unsuccessful in others.

Although Franklin D. Roosevelt is usually listed as the 32nd president of the U. S., the broken line of Fig. 1 (top)

MINISTERS" OF ENGLAND SERVED FROM 920 TO 1720, AND THE AGES AT WHICH BRITISH PRIME MINISTERS HAVE SERVED SINCE 1721.

presents data for only 27 different individuals because Grover Cleveland was both the 22nd and the 24th president of the U. S., and four other individuals were not elected to the presidency but assumed it as vice-presidents on the deaths of their immediate predecessors. In Fig. 1 (top) the vice-presidents who became presidents only by reason of the deaths of their predecessors have been omitted because it was found that vice-presidents have been elected most frequently at ages 50 to 54 inclusive, whereas, presidents have been elected most often at an older age interval, namely, at ages 55 to 59 inclusive.

When age differences in leadership are being studied, adequate allowance should be made for the fact that individuals do not always live to a ripe old age. Some die early; others in middle life. Therefore, since the representatives of the younger age groups are always likely to be more numerous than are the contemporary representatives of the older age groups, the younger age groups might conceivably exercise more frequent leadership merely because of their greater numerical strength. This difficulty has been overcome in the present study by computing the average amount of leadership that has been contributed by each age group.¹

¹ When two or more age-curves are set forth in a single graph, the curves should be so drawn as to be comparable. In Fig. 1 (top) and the other graphs that accompany this article, the age-curves have all been rendered comparable by the following procedure. The peak of each statistical distribution was arbitrarily assigned a value of 100 per cent. and the other numerals within the same statistical distribution were assigned proportionate percentage values. For example, in Fig. 1 (top), for the successful candidacies, those shown by the broken line, the peak of the distribution occurred at ages 55 to 59, inclusive. At this latter age interval the average number of successful candidacies *per living individual* was .120. In Fig. 1 (top), at age interval 55 to 59, inclusive, the figure .120 is plotted, therefore, as 100 per cent. At age interval 60 to 64, on the other hand, the average

Fig. 1 (top) indicates that U. S. presidential nominations are most likely to be won by men whose ages are from 55 to 59 inclusive. This holds both for the successful and for the unsuccessful presidential candidates. It is worth noting, however, that the age range of the successful nominees is less than half as wide as is the age range of the unsuccessful nominees. For the successful nominees the age range is from 46 to 67, inclusive, a range of only 21 years. For the unsuccessful nominees, on the other hand, the age range is from 36 to 85, a range of 49 years.

Although some candidates have been nominated for the presidency while they were still in their thirties, and one vice-president succeeded to the presidency when he was not yet 43, no one has been elected to the presidency prior to age 46. And none has been elected subsequent to age 67. Theodore Roosevelt's first inauguration (at age 42) was due to the assassination of President McKinley. Theodore Roosevelt was elected president on November 8, 1904. He was born on October 27, 1858. He was, therefore, 46 years and 12 days old when he was elected president. U. S. Grant, the next most youthful president, was 46 years, 6 months and 7 days of age when first elected president. Although William Henry Harrison was not inaugurated until he was 68, his election occurred when he was 67 years old. The first Roosevelt and the first Harrison are thus the youngest and the oldest candidates, respectively, that have been elected presidents of the U. S. Since, for a

number of successful candidacies per living individual was only .085. The decimal .085 is equivalent to only 71 per cent. of the maximum (71 per cent. of .120) and in Fig. 1 (top) the numeral .085 is plotted, therefore, as 71 per cent. The foregoing method of plotting the data should be borne in mind when studying the graphs, since this method takes account of the unequal numbers of individuals that were alive at the successive age intervals.

period of 150 years, the American voters have never elected a president of less than age 46, it seems apparent that the constitutional requirement that the president must be not less than age 35 has heretofore worked no particular hardship on potential candidates. Indeed, this constitutional requirement seems to have reflected rather than to have established custom and tradition.

Of the unsuccessful presidential candidates, William Jennings Bryan was nominated when he was only 36, and George B. McClellan was nominated at 38. Peter Cooper, on the other hand, was nominated when he was 85. It seems likely that Cooper had little hope of being elected and that he consented to be a candidate merely in order that he might bring before the public his views on the currency. The fact that the extremely young and the extremely old nominees have never once succeeded in their presidential candidacies may be due in part to the fact that very young and very old individuals are not likely to be nominated by the major political parties in which competition for the nomination is keenest. It is possible also that, even if they were to be nominated by the stronger political parties, the very young and the very old candidates would be handicapped in making their political campaigns.

In contrast to Fig. 1 (top), which reveals the ages at which American political leaders have attained presidential nominations, the solid line in Fig. 1 (middle) sets forth the chronological ages at which 218 deceased members of the cabinets of England served a total of 1,363 years. When two ministerial posts were held simultaneously, the years of such service were counted once only in the construction of Fig. 1 (middle). And when the same individual held various cabinet posts at different times, that individual's life-age was, of course, counted once only.

The broken line in Fig. 1 (middle)

presents the ages at which 133 different individuals served as presidents of various republics of the world (other than the U. S. A.) for a total of 706 years.² Some of these 133 presidents and ex-presidents are still living. For others of them death dates could not be found. In the broken line of Fig. 1 (middle) allowance for the probable death rate of the presidents was made by assuming that their death rate would be the same as was the death rate for the deceased members of the British cabinets. This assumption, while not entirely valid, perhaps, is nevertheless more nearly valid than the assumption that the death rate for the contemporary presidents would be the same as the death rate for the population as a whole because the general population includes infants, children, invalids, and so forth.

Fig. 3 (top) presents: (1) The chronological ages at which the first 32 presidents of the U. S. A. served a total of 151 years, or fractions of years, as presidents,³ and (2) the ages at which the last 29 hereditary rulers of France held their sovereignties. It reveals that, in proportion to the number alive at each successive age interval, hereditary rulers are most likely to serve as sovereigns from age 42½ until their deaths, whereas, as was stated previously, the presidents of the U. S. A. are most likely to serve as presidents during the relatively narrow age range of 55 to 59, inclusive.

The ages of the "chief ministers" of England from 920 to 1720, and of the British prime ministers since 1721 (2)

² The 133 presidents served from approximately 1890 to 1938, inclusive.

³ In this article service for a fraction of a year has been counted the same as service for an entire year, since it is assumed that the fractional parts of years tend to distribute themselves over the entire age range in the same manner as do the whole years. For a reason that has been previously mentioned, the 32 presidents of the U. S. A. include only 31 different individuals.

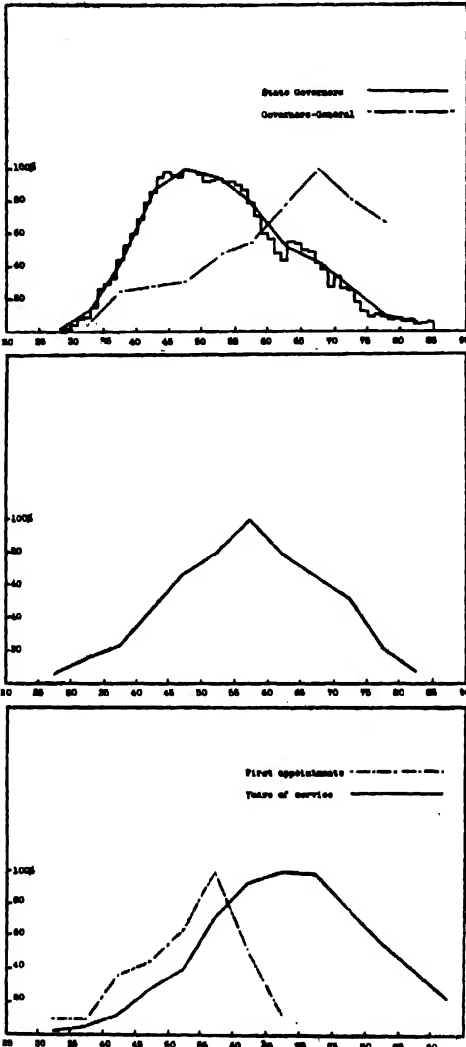

FIG. 2. GOVERNORS, AMBASSADORS, JUSTICES

Top: (A) AGES AT WHICH 932 DECEASED GOVERNORS OF STATES OF THE U. S. A. SERVED A TOTAL OF 3,885 YEARS, AND (B) AGES AT WHICH 32 GOVERNORS OF THE AMERICAN COLONIES HELD THEIR GOVERNORSHIPS. Middle: AMERICAN AMBASSADORS. AGES AT WHICH 176 DECEASED INDIVIDUALS REPRESENTED THE U. S. GOVERNMENT AS AMBASSADORS TO AUSTRIA-HUNGARY, ENGLAND, FRANCE, GERMANY, ITALY, JAPAN, RUSSIA AND SPAIN. Bottom: JUSTICES OF U. S. SUPREME COURT. (A) THE AGES OF 70 DECEASED JUSTICES AT THE TIME EACH WAS FIRST APPOINTED, AND (B) THE AGES AT WHICH THESE 70 MEN SERVED.

(3) were studied.* When these two sets of data were combined, Fig. 1 (bottom) was obtained. The reader will perhaps have noticed that, with the sole exception of the age-curve for hereditary rulers, all the age-curves presented thus far attain their peaks at ages 55 to 59, inclusive. It seems evident that, when political leadership depends upon something other than the accident of birth into a royal family, the most eminent leaders are most likely to reach the high points in their careers at ages 55 to 59, inclusive. However, for less outstanding political leaders, the above generalization may not hold true.

For example, Fig. 2 (top) presents: (1) The ages at which 932 governors of states of the U. S. A. served a total of 3,885 years, and (2) the ages at which 32 governors of the American colonies served a total of approximately (4, pp. 75 ff.) 286 years. It is evident from Fig. 2 (top) that the 32 governors of the American colonies were mostly elderly men. In many instances these colonial governors probably received their appointments as rewards for past services to the crown of England. In other instances they may have been given their

* In the following quotation Bigham explains the meaning of the term "chief ministers": "Ministers there always were, though it was only now and again that one of them became supreme. But if the prince was weak, or if he was often abroad, it was sometimes safer to commit the care of the realm to one individual rather than to several—a viceroy was better than a committee—and when the holder of such a charge was a man of mark, when he enjoyed in a special degree and for a considerable period the Sovereign's favor, then he overtopped his colleagues and became a Chief Minister. Insensibly the custom of having such an officer grew, and by the time that the nation was a conscious whole the idea of one particular statesman bearing the principal burden of government and wielding the principal power was already understood." (2) p. 1f. Eventually the "chief ministers" were replaced by the modern prime ministers. Sir R. Walpole is commonly regarded as the first of the prime ministers of England. Walpole became prime minister in 1721.

governorships for personal or for political reasons.

The solid line and the polygon of Fig. 2 (top) set forth data for 932 governors of the states of the U. S. since the American Revolution. Some of the 932 state governors were territorial governors appointed to office by the presidents of the U. S. Some were elected as lieutenant-governors and obtained their governorships as the immediate result of the death or the resignation of their predecessors in office. But most of the 932 governors were elected to office by their constituents. Since no difference in the shapes of the age-curves was found when data for the state governorships that were obtained in these three different ways were treated separately, the data for the 932 governors have been combined in constructing the solid line and the polygon of Fig. 2 (top). This solid line and the polygon reveal that, since the American Revolution, the state governors of the U. S. have served as governors most frequently when they were from ages 43 to 49, inclusive. The earlier ages of state governors than presidents of the U. S. is probably due in part to the fact that a governorship is often a stepping-stone to the presidency, many of the presidents having been state governors prior to their election as president.

Additional data regarding governors of the British dominions were obtained by study of the Governors-General of Canada since 1861, and for the Governors-General of British dominions other than Canada for the years 1890 to 1938, inclusive. The two age-curves which were constructed by use of these latter data each yielded a peak at ages 60 to 64, inclusive. One may conclude that American state governors are more often "on the make" politically than are the Governors-General of the British dominions.

AMERICAN AMBASSADORS

Fig. 2 (middle) presents data for a sum total of 780 years of American diplomacy, namely, the chronological ages of 176 deceased ambassadors who have represented the U. S. government in Austria-Hungary, Great Britain, France, Germany, Italy, Japan, Russia and Spain, (4 pp. 67 ff.) from the time of the founding of the U. S. government until approximately the year 1900. It will be seen from Fig. 2 (middle) that the age interval of most frequent diplomatic service to major foreign powers is that from 55 to 59, inclusive. When diplomatic service to minor powers was studied similarly the resultant age-curve exhibited a much less definite peak. Very responsible diplomatic service is thus likely to be performed at a narrower age range than is diplomatic service of lesser importance. Some cynics may assert at this point that many of our foreign ambassadors have been incompetent amateurs who owed their diplomatic posts to the large campaign contributions which they made to the successful political parties rather than to their merit as ambassadors. As stated previously, the present article makes no attempt to evaluate the services of the leaders for whom data are presented herein.

MILITARY AND NAVAL LEADERS

Fig. 3 (middle) reveals: (1) The ages at which 198 of the world's famous military leaders led their armies into 520 land battles, and (2) the ages at which 51 naval commanders led their fleets into 98 naval encounters. The age-curves of Fig. 3 (middle) are based upon the life records of such immortals as Alexander the Great, Frederick the Great, Julius Caesar, Napoleon, Admiral Nelson and scores of less renowned leaders. The names of the military and the naval leaders, the battles in which they served as commanders, and the dates on which

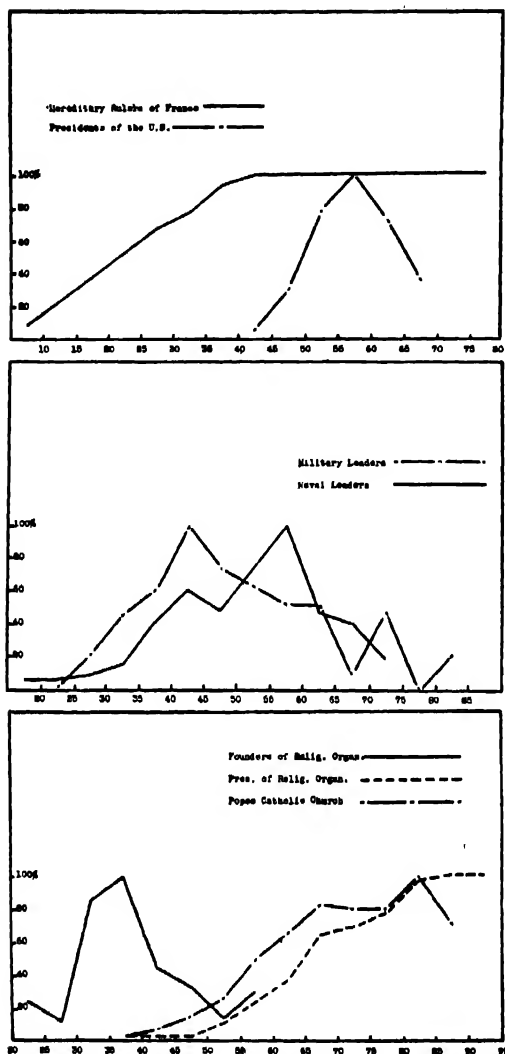

FIG. 3. STATE, WAR, RELIGIOUS LEADERS

Top: (A) AGES AT WHICH THE LAST 29 HEREDITARY RULERS OF FRANCE SERVED AS RULERS, AND (B) AGES AT WHICH PRESIDENTS OF THE U.S. SERVED AS PRESIDENTS FROM 1789 TO 1938, INCLUSIVE. Middle: WAR LEADERS. (A) AGES AT WHICH 198 DECEASED MILITARY LEADERS LED THEIR ARMIES INTO 520 LAND BATTLES, AND (B) AGES AT WHICH 51 DECEASED NAVAL COMMANDERS LED THEIR FLEETS INTO 98 NAVAL ENCOUNTERS. Bottom: RELIGIOUS LEADERS. (A) AGES AT WHICH 51 DECEASED INDIVIDUALS SERVED AS POPES OF THE ROMAN CATHOLIC CHURCH, (B) AGES AT WHICH 101 OTHER DECEASED INDIVIDU-

they led their forces into battle, were obtained from Harbottle's "Dictionary of Battles" (5). In Fig. 3 (middle) data for military and naval commanders were included only when the leaders bore such purely military titles as general, field-marshal, admiral, colonel, and the like. Data for leaders who possessed royal titles such as king, prince, and so forth, were excluded because it was found that when data for royal leaders were used in the construction of age-curves, the curves tended to be broad and flat with no very definite peaks. It seems probable that, as compared with the non-royal leaders, the royal leaders were more often mere figure-heads who exercised little or no genuine leadership. It therefore seemed justifiable to omit data for the royal military and naval leaders.

Fig. 3 (middle) suggests that the non-royal military leaders were most frequently of ages 40 to 44, inclusive, whereas, the non-royal naval commanders were most frequently of ages 55 to 59, inclusive. Is this difference in the peaks of the age-curves due to the different demands that are made upon the two kinds of commanders? Or is it perhaps due to custom, tradition and other factors of doubtful relevance? To the present writer it seems likely that subordinate army officers are more frequently given opportunity to command separate military units, and thus to reveal their real ability as leaders, than are subordinate naval officials. If this hypothesis is valid, it would explain why seniority is more easily brushed aside in the army than in the navy. Another possible explanation is the fact that the number of different individuals who acquire technical naval training is probably not as great as is the number

ALS SERVED AS PRESIDENTS OF VARIOUS RELIGIOUS ORGANIZATIONS, AND (C) AGES AT WHICH 54 FOUNDERS OF RELIGIONS, AND OF RELIGIOUS SECTS AND SOCIETIES LAUNCHED THEIR MOVEMENTS.

who receive technical military training. Finally, it is to be remembered that most of the naval leaders are of relatively recent date; many of the generals lived in earlier times, and physical vigor was probably more essential to military leadership in earlier times.

JUDICIAL LEADERS: MEMBERS OF THE U. S. SUPREME COURT

Fig. 2 (bottom) sets forth: (1) The ages of 70 deceased justices of the U. S. Supreme Court at the time each of these individuals received his first appointment thereto, and (2) the ages at which these 70 justices served as members of the Supreme Court. Collectively, the 70 justices served a total of approximately 1,444 years (4, pp. 73 ff.). Fig. 2 (bottom) reveals that some justices were appointed to the Supreme Court while they were still in their thirties. These latter appointments were made during the early days of the republic when young men comprised a much larger proportion of the total population than they do to-day. Fig. 2 (bottom) reveals further that, although some individuals received their first appointments to the Supreme Court when they were in their sixties, the largest number were first appointed when they were from 55 to 59, inclusive.

The solid line of Fig. 2 (bottom) shows that, although a few of them have served prior to age 35 and certain others have served when they were beyond 90, justices of the U. S. Supreme Court have served most frequently at ages 65 to 69, inclusive. Eighty-eight per cent. of the U. S. Supreme Court service has been rendered by men who were beyond 50 years of age, and 41 per cent. of such service has been rendered by men who were above 65. This finding is perhaps due in part to the well-known fact that the age of retirement for justices of the Supreme Court is contingent upon the personal desires of the incumbents. When retirement from a position of power and prestige is left to the pleasure

of the incumbent, retirement is likely to be much delayed, and sometimes it does not occur at all.

Data were obtained similarly for 55 deceased federal district and circuit court judges who served collectively for a total of 1,205 years. The average length of service for these judges was almost 22 years, and they served most frequently at ages 60 to 64, inclusive. The fact that the federal district and circuit judges have served at somewhat younger chronological age levels than have the justices of the Supreme Court may be due in part to the fact that the federal district and circuit courts serve as "feeders" to the U. S. Supreme Court.

MEMBERS OF THE PRESIDENT'S CABINET

When age-curves were drawn portraying: (1) The ages of *attaining* membership in the cabinet of the president of the U. S. A., and (2) the ages of *serving* in the president's cabinet, the latter two curves were found to be of almost identical shape, the maximum points of both of these age-curves occurring at ages 50 to 54. (See Fig. 4, top.) The reason for the similarity in the shapes of these latter two age-curves is perhaps partly the fact that members of the president's cabinet usually resign their positions whenever a new president is elected. In the U. S. it is true also that cabinet members sometimes resign their posts in order to engage in private endeavor, or to work, as lobbyists and the like, for various business groups. The fact that, in the U. S., membership in the president's cabinet is so often regarded as a stepping-stone to "something better" may account in part both for the fact that the two age-curves in Fig. 4 (top) are so nearly identical in shape and also for the fact that the members of the president's cabinet tend to be somewhat younger than do members of British cabinets.

**PROFESSIONAL LEADERSHIP: PRESIDENTS
OF NATIONAL PROFESSIONAL ORGANIZATIONS**

A curve was constructed which set forth the chronological ages at which 915 Americans were honored by being elected as presidents of over 50 national scientific and learned societies (4, pp. 133-138). The peak of this curve occurred at ages 50 to 54, inclusive. It was found, however, that professional recognition and leadership are won much more quickly in some lines of endeavor than in others. Past presidents of both the American Medical Association and the American Bar Association were found to have held their presidencies most often at ages 60 to 64, inclusive. (See Fig. 4, middle.) But for both the American Chemical Society and the American Psychological Association past presidents have served most frequently from ages 45 to 49.

RELIGIOUS LEADERSHIP

Fig. 3 (bottom) sets forth: (1) The ages at which 51 deceased men served a total of 495 years as popes of the Roman Catholic Church, (2) the ages at which 101 other individuals served a total of 770 years as presidents of 13 different religious organizations (4, pp. 133 ff.), and (3) the ages at which 54 deceased founders of religions, and of religious sects and societies, first launched their movements (4, p. 152; 7, 6). It should be understood, of course, that many of these founders continued to preach and to carry on their work as long as they lived. And, in many instances, the influence of these founders continued to increase even after their deaths.

Fig. 3 (bottom) suggests that, whereas, new religious movements are most likely to be launched by individuals who are still in their thirties, after they have once been established, religious organizations are likely to receive most of their nominal leadership from rather elderly men.

Thus, more than 97 per cent. of the papal years of service were rendered by men who were past 50, and more than 65 per cent. of the papal years of service were rendered by men who were of ages 65 or above. Of the presidents of the non-Catholic religious organizations, 93 per cent. of their administrative years were contributed by persons of more than age 50, and 56 per cent. of this service was rendered by persons over 65.

Similar data were assembled for 148 deceased Protestant bishops who served as bishops for a total of 3,007 years, the average length of service as a bishop being 20.32 years. The peak of the age-curve that was constructed by use of these data occurred at ages 70 to 74. The ages of members of the College of Cardinals of the Roman Catholic Church for the 11-year period, from 1928 to 1938, inclusive, were likewise studied. The apogee of the resultant age-curve occurred at ages 65 to 69. Collectively, the foregoing figures seem to validate an assertion that was made some years since by G. Stanley Hall, namely:

Thus it came that, while men in their prime conceived the great religions, the old made them prevail. Thus, too, instituted and dogmatic religion owes its existence chiefly to men past the meridian of life. The old did not invent belief in supernatural powers or persons but needed and used it to sustain their position when physical inferiority would have otherwise compelled them to step aside and so they made themselves mediators between gods and men. They directed and presided over rites and ceremonies and took possession of the keys of the next world, enforced orthodoxies for the sake of order, and established and equipped the young to aid them in this work. They were behind the scenes and held the secrets, realizing the utility to society and also to themselves of much for which they had lost the primitive ardor of belief. Thus the revivalist and the reformer have always found the old arraigned against them. (8, p. 420.)

EDUCATIONAL LEADERS

Fig. 4 (bottom) the dash line presents the chronological ages at which 364 American college and university presi-

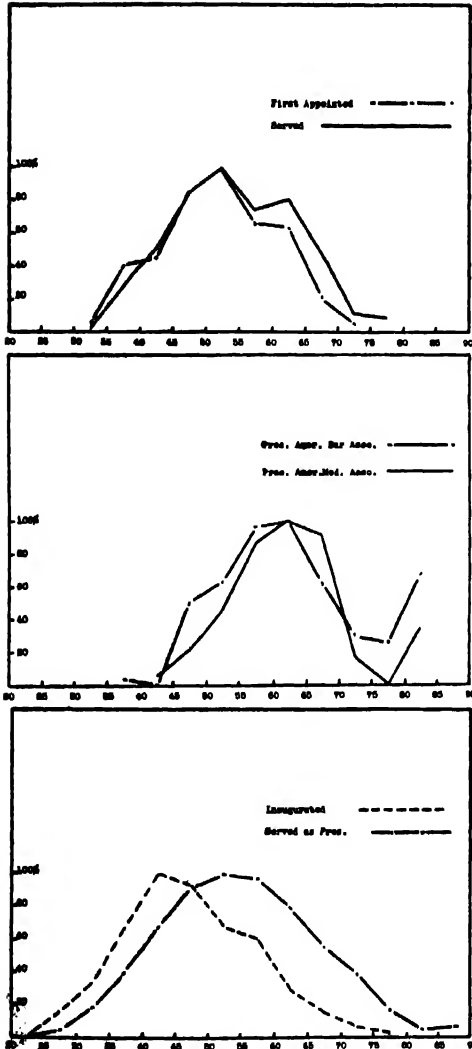

FIG. 4. POLITICS, LAW, MEDICINE, EDUCATION

Top: (A) AGES AT WHICH 248 DECEASED INDIVIDUALS ATTAINED MEMBERSHIP IN THE CABINET OF THE PRESIDENT OF THE U.S., AND (B) AGES AT WHICH THESE 248 INDIVIDUALS SERVED A TOTAL OF 1,017 YEARS. Middle: PROFESSIONAL LEADERS. (A) AGES OF 57 PAST PRESIDENTS OF THE AMERICAN BAR ASSOCIATION, AND (B) AGES OF 91 PAST PRESIDENTS OF THE AMERICAN MEDICAL ASSOCIATION. Bottom: EDUCATIONAL LEADERS. (A) AGES AT WHICH 364 AMERICAN COLLEGE AND UNIVERSITY PRESIDENTS WERE INAUGURATED AS PRESIDENTS, AND (B) AGES AT WHICH THESE 364 INDIVIDUALS SERVED AS COLLEGE AND UNIVERSITY PRESIDENTS.

dents were inaugurated as presidents (4, pp. 117 *ff.*). In this figure data are presented for 450 inaugurations but for only 364 different individuals. This apparent discrepancy is due to the fact that when a given president moved from one college to be the president of another, that individual's inauguration was counted as often as he became a "new" college president.

The five-year interval during which "new" college presidents are most frequently inaugurated seems to be that from ages 40 to 44, inclusive. This is the age interval during which American college and university presidents have been most often inaugurated as presidents from the time of the establishment of the 56 leading educational institutions for which data were available until approximately the year 1900. An attempt was made to partition the data for the presidencies of large, as compared with those for small institutions, and for privately endowed as compared with state universities. No significant age differences were found when the data were thus partitioned and the present writer doubts that they exist.

A college president's inauguration marks only the beginning of his administration. During what years of their lives are college and university presidents most likely to exercise their presidential functions? The broken line of Fig. 4 (bottom) reveals that, in proportion to the number of them that are alive at each successive age interval, American college and university presidents serve as presidents most frequently from ages 50 to 54. The age interval of most frequent service is thus ten years later than is the age interval of most frequent inauguration.

COMMERCIAL AND INDUSTRIAL LEADERS

In Fig. 5 (top) the dash line sets forth the ages of approximately 1,400 individuals whose names were found in the

1938 edition of "Who's Who in Commerce and Industry" (9). The broken line of this figure sets forth a second sampling of approximately the same size as the first sampling. The method that was employed by the editors for selecting the business and the financial leaders whose names are included in "Who's Who in Commerce and Industry" is described in the following explanatory paragraphs which are taken from the preface of the book:

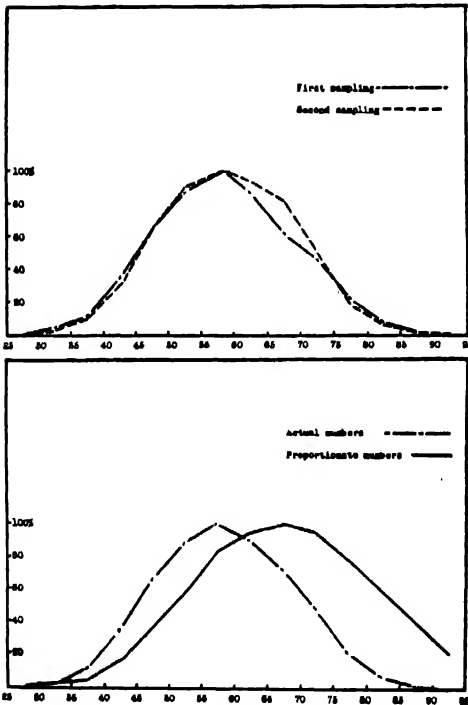

FIG. 5. LEADING MEN IN BUSINESS

Top: AGES OF MEN WHOSE NAMES WERE INCLUDED IN THE 1938 EDITION OF WHO'S WHO IN COMMERCE AND INDUSTRY. (A) FIRST SAMPLE OF APPROXIMATELY 1,400 NAMES. (B) SECOND SAMPLE OF APPROXIMATELY 1,400 NAMES. Bottom: AGES OF 2,800 MEN WHOSE NAMES WERE INCLUDED IN THE 1938 EDITION OF WHO'S WHO IN COMMERCE AND INDUSTRY. (A) NO ALLOWANCE IS HERE MADE FOR POPULATION DIFFERENCES AT SUCCESSIVE AGE LEVELS. (B) ALLOWANCE IS HERE MADE FOR POPULATION DIFFERENCES AT SUCCESSIVE AGE LEVELS.

The volume lists the chairmen of boards, presidents and other important officers of industrial, manufacturing and transportation corporations; executives of utilities, communications and mining companies; heads of insurance companies, financial and investment institutions and banks; merchants of leading department stores and mercantile establishments, and elected officers of national and international trade associations.

Not all persons prominent in commerce and industry are included in this volume. Only the most important executives are listed. Generally, the book contains the heads of corporations whose net worth is over \$1,000,000.00. Aside from other special considerations, that is the basic principle underlying the admission of business leaders. Needless to say, with such stringent requirements for admission, only those deserving of inclusion can find their way into this book.

... There is no charge for the inclusion of biographies in "Who's Who in Commerce and Industry." *Not a single name in the book has been paid for and none can be paid for.* (9, pp. iii-iv.)

Since the two age-curves of Fig. 5 (top) are almost identical in shape, the data for both curves were combined in constructing the broken line of Fig. 5 (bottom). In examining the broken line of Fig. 5 (bottom) the reader should bear in mind that this curve presents merely the absolute numbers of commercial and industrial leaders per chronological age interval, no allowance being made in this curve for the fact that the representatives of the younger age groups are more numerous than are the representatives of the older age groups. The solid line of Fig. 5 (bottom), on the other hand, takes into account the population differences at the various age levels.

The two curves of Fig. 5 (bottom) reveal that although, as regards absolute numbers, the eminent leaders in commerce and industry are most frequently of ages 55 to 59, inclusive, when proper allowance is made for the fact that fewer persons are alive at the older age levels, the resultant age-curve attains its peak at ages 65 to 69, inclusive. In other words, in proportion to its size, age

group 65 to 69 contributes the most commercial and industrial leadership. In studying the curves of Fig. 5 (bottom) the reader should also remember that none of the leaders whose names were listed in "Who's Who in Commerce and Industry" had retired at the time the foregoing volume was published. All were nominally active officials in large business and industrial concerns.

CONCLUDING REMARKS

Because competition and struggle play such a large part in all life, some philosophers have advanced the theory that power is the most universal and the most fundamental of human motives. Some have even gone so far as to insist that every man is basically a *Macht-mensch*, man's most coveted goal being the enhancement of his own personal power. The present study assumes only that within each of the age groups there are numerous individuals who would have attained the kinds of leadership that have been cited herein if they had been able to do so. If this latter assumption is a valid one, it may be inferred that the accompanying age-curves reveal the relative ability of the members of the several age groups to acquire and to retain the types of leadership that have been mentioned herein.

One need not infer that any of these curves reveals the chronological ages at which adult "general intelligence" is at its maximum. There are, of course, many different kinds of leadership and the peak of the age curve varies somewhat with the kind of leadership that is under consideration. For example, the military leaders have been most frequently of ages 40 to 44, whereas, the top-flight political leaders have been most frequently of ages 55 to 59, inclusive. Moreover, it seems obvious that a given type of leadership, for example, political leadership, is often due not to

any one variable, but to an indeterminate number of such factors as self-confidence, forcefulness, persistence, the art of persuasion, the ability to grasp and to express the will of the masses, the ability to compromise, the times during which the leader lives, and so forth. Some writers would maintain that the leader is not a biologically recognizable variety of human being at all, and that much leadership is, in part at least, a sociological phenomenon. For example, is Adolf Hitler's political leadership an inevitable personal characteristic which Hitler could not have escaped, or is Hitler's leadership not due in part to the times, and to the situation that resulted from the enforcement of the provisions of the Treaty of Versailles? Probably no competent thinker would insist that there is any *one* variable that enabled Hitler to attain his leadership, or that Hitler would have attained equal eminence as a leader if he had been born a hundred years prior to the First World War.

Volumes might easily be written in an attempt to set forth the full meaning and the various implications that may be derived from the accompanying age-curves. In the brief space at his disposal, the writer will touch briefly upon only one or two of the very large number of aspects that might well have been considered.

As has been pointed out by G. Stanley Hall (8) and others, during the evolution of *homo sapiens*, those aging individuals who have felt their physical powers beginning to wane, at least the more sagacious of them, have invented or adopted numerous devices by means of which they have safeguarded their persons, their goods and their prestige. When the sub-human organism's physical powers begin to wane, the sub-human creature is likely to lose its rôle of leadership rather quickly. Man (the political animal), however, has evolved

means of social control which enable him to exert his greatest political influence in his late fifties. In a former study (1-f) data were published which suggest that man attains the peak of his physical strength and skill at about age 27 or 28. The present study suggests that man does not attain his full political stature until approximately 30 years after he has passed the peak of his physical prowess. Collectively, these studies thus reveal a situation that is quite different from that which is to be found in any of the lower animal groups.

It is obvious that in human society the various age groups have innumerable mutual interests. It is equally apparent that in some respects the old and the young are in a state of constant competition. Although our data reveal that, in the struggle for leadership, the older age groups have been eminently successful, they show also that the chronological age at which one is most likely to do his most important work varies with the nature of the task. It seems clear that for many activities there ex-

ists a relatively brief age interval during which groups of individuals will be most likely to attain their greatest success. For example, it has been shown in former articles (1) that several kinds of creative thinking are most likely to culminate when the creative thinker is still in his thirties. But the present study suggests that the top of the political ladder is most likely to be reached by men who are in their late fifties.

This study has dealt only with the age factor. Clearly the statistical distribution of these eminent leaders at various periods of their lives with respect to such factors as height, weight, intelligence-test scores, extroversion-introversion scores, educational attainment, and the like, would be equally as, if not more, interesting than is the statistical distribution of their ages. Fairly complete individual case-studies would be even more interesting. Unfortunately, chronological age is about the only kind of adequate information that the present writer has been able to obtain regarding these leaders.

AVERAGE AMOUNT OF VARIOUS KINDS OF LEADERSHIP PER FIVE-YEAR INTERVAL.
THE PEAK OF EACH STATISTICAL DISTRIBUTION IS IN ITALICS

Type of leadership	Age-interval										
	30-34	35-39	40-44	45-49	50-54	55-59	60-64	65-69	70-74	75-79	80-84
Successful U. S. pres. candidacies037	.061	.120	.085	.042
Unsuccessful U. S. pres. candidacies016	.040	.069	.088	.063	.053	.043	.015	.032
Members of the cabinets of England . .	.034	.051	.109	.207	.242	.889	.209	.188	.150	.116	.070
Pres. of republics other than the U. S. A.	.005	.024	.056	.096	.133	.166	.140	.137	.091	.063	.053
Hereditary rulers of France783	.939	1.00	1.00	1.00	1.00	1.00	1.00	1.00	1.00	...
Pres. of the U. S. Ages of serving019	.110	.278	.366	.261	.129
The "chief ministers" and the prime ministers of England073	.151	.197	.325	.325	.389	.318	.268	.324	.240	.147
State governors of the U. S.023	.079	.155	.177	.169	.141	.094	.076	.045	.018	.012
Gov. of the Amer. colonies025	.113	.127	.140	.218	.250	.357	.456	.371	.308	...
U. S. ambassadors. Ages of serving . .	.028	.042	.084	.126	.149	.157	.146	.119	.096	.040	.011
Non-hereditary military commanders . .	.058	.074	.120	.090	.077	.082	.064	.012	.058027
Non-hereditary naval commanders012	.033	.049	.039	.060	.080	.036	.032	.016
Justices U. S. Supreme Court008	.008	.023	.029	.042	.084	.033	.009
Justices U. S. Supreme Court014	.043	.097	.235	.335	.606	.776	.818	.832	.730	.480
Members of Pres. cab.002	.020	.023	.044	.061	.034	.033	.011	.002
Members of Pres. cab. Ages of serving .	.004	.055	.008	.162	.191	.142	.156	.091	.020	.017	...
Pres. Amer. Bar Asso. Ages of serving004	.014	.029	.053	.061	.056	.011022
Pres. Amer. Med. Asso. Ages of serving003025	.031	.048	.051	.036	.019	.023	.036
Founders of religions and sects052	.040	.027	.020	.009	.018
Popes. Ages of serving020	.020	.020	.096	.227	.308	.643	.686	.771	.980
Pres. of other religious organizations008	.030	.059	.112	.208	.276	.365	.343	.341	.486
Pres. Amer. Col. and Univ.018	.037	.064	.051	.037	.083	.016	.008	.003	.002	...
Pres. Amer. Col. and Univ.077	.164	.272	.378	.469	.597	.324	.223	.160	.071	.023
Commercial and industrial leaders* . .	23	59	175	337	455	518	463	367	245	106	36

Additional age ranges : 85-89 : unsuccessful presidential candidacies, .067 ; members of English cabinets, .029 ; presidents of republics, .059 ; ministers of England, .083 ; justices U. S. Supreme Court, .333 (ages 90-94, .185) ; popes, 1.00 (ages 90-94, 1.00) ; presidents of religious org., .300 ; presidents of Amer. Col. & Univ., .027.

* For the commercial and industrial leaders absolute numbers are given, no allowance being made for population differences at the various age levels.

OPTIMUM AGES FOR LEADERSHIP

175

SUMMARY OF FINDINGS WITH REFERENCE TO CHRONOLOGICAL AGE AND TYPE OF LEADERSHIP

Type of leadership	No. of cases	No. of men	Ave. per indiv.	Median C.A.	Mean C.A.	S.D.	Peak years
Successful U. S. pres. candidates	38	27	1.41	56.6	56.98	5.60	55-59
Unsuccessful U. S. pres. candidates	108	73	1.16	57.0	57.36	9.30	55-59
Members of the cabinets of England	1,383	218	6.25	55.23	55.36	10.80	55-59
Pres. of republics other than the U. S. A.	706	133	5.31	56.87	57.37	10.55	55-59
Hereditary rulers of France. Ages of serving	762	29	26.3	36.23	36.23	13.85	42+
Pres. of the U. S. Ages of serving	151	31	4.87	56.2	56.37	5.80	55-59
"Chief ministers" and prime ministers of England	589	63	9.50	53.45	53.54	12.20	55-59
State governors of the U. S. Ages of serving	3,885	932	4.17	49.63	50.47	9.55	43-49
Gov. of the Amer. colonies. Ages of serving	286	32	8.94	61.50	59.20	10.10	65-69
U. S. ambassadors. Ages of serving	780	176	4.43	57.67	54.69	10.80	55-59
Non-hereditary military commanders	520	195	3.63	44.91	46.51	11.38	40-44
Non-hereditary naval commanders	118	83	1.42	50.25	48.90	11.43	55-59
Justices U. S. Supreme Court. Ages when app'ted.	70	70	49.46	53.01	7.85	55-59
Justices U. S. Supreme Court. Ages of serving	1,144	70	10.34	62.62	62.45	10.10	65-75
Members of Pres. cab. Ages when appointed	248	248	50.94	51.21	8.30	50-54
Members of Pres. cab. Ages of serving	1,017	248	4.10	52.68	52.77	8.60	50-54
Pres. Amer. Bar. Asso. Ages of serving	57	57	1.00	60.38	65.22	7.30	60-64
Pres. Amer. Med. Asso. Ages of serving	91	91	1.00	59.27	64.42	8.65	60-64
Founders of religions and sects	54	54	1.00	37.75	39.26	8.35	35-39
Popes. Ages of serving	495	51	9.70	67.33	68.41	9.15	82-92
Pres. of other religious organizations	770	101	7.62	64.81	66.01	10.00	80-84
Pres. Amer. Col. and Univ. Ages when inaug.	450	364	1.24	45.54	46.34	9.00	40-44
Pres. Amer. Col. and Univ. Ages of serving	3,853	364	10.58	52.18	52.50	10.50	50-54
Commercial and industrial leaders	2,800	2,800	57.07	58.60	10.4	65-69

1. (a) Lehman, H. C.: "The Creative Years in Science and Literature," *THE SCIENTIFIC MONTHLY*, 43: 151-162, 1936.
- (b) Heidler, J. B., and Lehman, H. C.: "Chronological Age and Productivity: Various Types of Literature," *The English Journal* (College Edition) 155: 294-304, 1937.
- (c) Lehman, H. C., and Ingerham, D. W.: "Man's Creative Years in Music," *THE SCIENTIFIC MONTHLY*, 48: 431-443, 1939.
- (d) Lehman, H. C.: "The Creative Years: 'Best Books,'" *THE SCIENTIFIC MONTHLY*, 45: 65-75, 1937.
- (e) Lehman, H. C.: "The Creative Years: Medicine, Surgery, and Certain Related Fields," *THE SCIENTIFIC MONTHLY*, 48: 450-462, 1941.
- (f) Lehman, H. C.: "The Most Proficient Years at Sports and Games," *The Research Quarterly* of the American Association for Health and Physical Education, 11: 3-19, 1938.
2. Bigham, C.: "The Chief Ministers of England 920-1720." New York: E. P. Dutton and Company, 1923. Pp. x + 422.
3. *Encyclopedia Britannica*. Fourteenth Edition. Vol. 15. Pp. 551 ff.
4. "The National Cyclopedia of American Biography." Index and Conspectus. New York: James T. White and Company, 1906.
5. Harbottle, E. B.: "Dictionary of Battles from the Earliest Date to the Present Time." New York: E. P. Dutton and Company, 1905. Pp. 298.
6. Hastings, J.: "Encyclopedia of Religion and Ethics." New York: Charles Scribner's Sons. 1923. In 13 volumes.
7. Hume, R. E.: "The World's Living Religions." New York: Charles Scribner's Sons. 1935. Pp. viii + 312.
8. Hall, G. S.: "Senescence: The Last Half of Life." New York: D. Appleton and Company, 1923. Pp. xxvii + 525.
9. "Who's Who in Commerce and Industry. The International Business 'Who's Who.'" New York: Institute for Research in Biography, Inc., 2nd edition, 1938. Pp. viii + 1010.

SCIENCE AND JOHN DONNE

By O. P. TITUS

EVENING COLLEGE, UNIVERSITY OF CINCINNATI

Publication of Ernest Hemingway's "For Whom the Bell Tolls" has brought about another revival of interest in the writings of John Donne. Whether this interest springs from superficial curiosity, a response to the beauty of the quotation from which Hemingway takes his title, or from a deeper felt affinity in thought and feeling with Donne's idea of the interrelation and interdependence of men, which is daily and irresistibly forced upon us by the present horrors of world war, is impossible to say. It would be interesting to know the reactions of the new readers of John Donne, to know how a closer acquaintance with the sixteenth century genius affects them, whether or not this new impetus to interest in Donne will outlast or outgrow, in a popular sense, that other revival which took its rise in the 1912 edition of Donne's poems by Professor Grierson, and which reached such literary proportions that by 1926, as T. S. Eliot says, "the subject was already popular, almost topical."

That many who approach Donne in curiosity will remain to read with amazement and pleasure is obvious. There is a curious kinship in the bewilderment felt by thousands, oppressed by the cataclysmic events of to-day, with the personal bewilderment and soul-torment felt by Donne, living in an age of scientific revolution.

Born in 1573, Donne came into a world shaped by medieval scholasticism, a world apparently forever secure in its physical and spiritual boundaries. It proved, however, a world to be wholly reshaped by the scientific discoveries of Copernicus, Kepler, Tycho Brahe and Galileo. That Donne's peculiar difficul-

ties and torments were due wholly to this fact is not true. "Science is only one of the things which color the glass through which the writer looks at life." Donne's troubles arose, as well, from the circumstances of his religious environment, his temperament and his secret marriage, with its disastrous effects on his prospects of court preferment. But the effect of the doubt cast by science on man's material universe undoubtedly played its part in Donne's distrust of reason and ultimate triumph in faith, and was mirrored in his poetry and prose to such an extent that "the break-up of a whole system of thought is reflected in his pages," so that in them may be seen "the effort of the late Renaissance mind to make adjustment to its world of changing values without sacrificing its regard for the equal claims of emotion and reason."

Donne was the son of a prosperous trader. His mother was the daughter of John Heywood, epigrammatist and writer of interludes, and the granddaughter of Sir Thomas More. He was brought up under strict Catholic guidance and in an atmosphere of intrigue and persecution. Although Donne, after his years of doubt and study, rejected the Catholic faith and later attacked the Jesuits in "Ignatius, his Conclave," he received from his early training an impress which lasted throughout his life.

In an age in which men had an immoderate thirst for learning, Donne's learning was immense. He had a feverish craving for experience and excitement and says of himself that he had "an Hydroptique, immoderate desire of humane learning and languages." It was these characteristics which led

Donne to study languages and law, to master "the grounds and uses of physic," to compare with passionate attention the doctrines of the Catholic church and the Church of England, and to read with open mind the scientific writings of Copernicus, Kepler, Tycho Brahe, Galileo and others, and which are reflected in his poems and prose. In the "Satires" he says that he was to be found at midnight "fighting in the streets with untrussed gallants" and in the poems, "The Storm" and "The Calm," he writes vividly of his experiences when on a naval expedition in the service of the Lord of Essex which was undertaken, he says in "The Calm," from

. . . hope of gaine,
Or to disuse mee from the queasie paine
Of being belov'd, and loving, or the thirst
Of honour. . . .

The profligacy of Donne's youth has been questioned and the suggestion made that his cynical attitude toward women may have been, in part, a pose and a species of bravado. The evidence in the "Satires" and "Songs and Sonnets" scarcely seems to bear this out. In his later life Donne certainly felt and expressed great regret for the adventures of his youth, which must have been, even in those times, somewhat too openly chronicled and detailed for the peace of mind of a man who had become a great dignitary in the Church of England, one whose religious faith had come to equal in intensity his youthful qualities of skepticism and cynicism, and who, despite his attitude toward women, had sacrificed all material prospects for love and had found in his love for his wife, Anne More, a steadfast anchorage in sickness, poverty and disappointment.

The revolution in the state of mind of the Donne who wrote "The Canonization" in comparison with that of the Donne who, with St. Augustine, could cry in yearning, "Too late have I sought Thee oh Beauty old yet ever new," is

equally as great as that brought about in the conception of the universe by the accumulation of facts about nature and the development of an objective and critical approach to material phenomena. It represents a change in the microcosm comparable to those in man's conception of the macrocosm, and displays a mind open to scientific facts, yet, in the words of Mr. Charles Coffin, refusing "to relax hold on the idea that the very nature of things in essence is an interpenetration of mind and matter." Donne is able in the face of the "paradoxical and seemingly contradictory suggestion of the physical and the spiritual, the material and the ideal, the manifestation of both the real and the unreal" to lay hold on the things of the spirit as the ultimate triumph of all knowledge and the goal toward which a seeming chaos might still point.

Donne's knowledge of the scientific discoveries of his times is evident both in his prose and poetry. In "Ignatius, his Conclave," Donne makes good use of his knowledge of astronomy; and in "Bia-thanatos," a discussion of suicide, he cites Kepler in refutation of St. Augustine's argument against innovation and shows his acceptance of the new philosophy by remarking that "the reason which moved Aristotle seems now utterly defeated." It is in his poems, however, that Donne's scientific information serves him with most illuminating effect. In the "Anniversaries," written on the death of Elizabeth Drury, a girl of fifteen, there are passages which are almost unintelligible except in the light of Donne's interest in the new science. He writes:

And new Philosophy calls all in doubt,
The Element of fire is quite put out;
The Sun is lost, and th' earth, and no man's wit
Can well direct him where to looke for it.
And freely men confess that this world's spent,
When in the Planets, and the Firmament
They seeke so many new; they see that this
Is crumbled out againe to his Atomies.
'Tis all lit peeces, all coherence gone;
All just supply, and all Relation:

Again in the same poem he says:

We think the heavens enjoy their Spherical,
Their round proportions embracing all.
But yet their various and perplexed course,
Observed in divers ages, doth enforce
Men to find out so many Eccentrique parts,
Such divers downe-right lines, such overthwarts,
As disproportion that pure forme: It teares
The firmament in eight and forty sheires,
And in these Constellations then arise
New starres, and old doe vanish from our eyes:

It is also in "The Anatomie of the World" that Donne refers to the new mineral drugs of Paracelsus.

In contrast with the melancholy tone of the lines quoted above are these from "Epithalamion" in which Donne refers to the idea that if it were true that the earth moved, whirling about in space, all that inhabited it would be in chaotic motion:

And were the doctrine new
That the earth mov'd, this day would make it
true;
For every part to dance and revell goes.
They tread the ayre, and fal not where they
rose.

Passion and melancholy are the chief characteristics of Donne's "Satires" and "Songs and Sonnets." His devotional poems, both those written before and those written after he took Orders, rank among the greatest contributions to this form of poetry. He was an innovator in style and form who "brought the toughest of intellectual disciplines to the expression of emotion." His influence has been more lasting than that of any other of the so-called metaphysical poets, extending to the present time.

Writing of Donne in an essay called "Donne and Today," George Williamson has this to say of his influence as it affects T. S. Eliot and other contemporary poets:

The great hold of Donne and the Elizabethans upon Eliot and other contemporary poets lies in this: they provide the greatest instance in our literature of poets moulding language to new developments of sensibility. For the metaphysical phase of this extension Donne created an idiom in which emotion is patterned by intellect,

tightened up by reason, and salted by wit. . . . And Eliot's dictum that emotion is made precise and definite by intellect probably owes much to the study of Donne.

He says, too, that

in nothing are Donne and Eliot more alike than in the fact that each has taught his fellow poets to be contemporary. . . . To be contemporary in the right sense means to find the peculiar emotional tension of the time and to mould language to its expression. For Donne and Eliot this meant that each had to create a form adequate to contain the experience of a man who has awakened to the insufficiency of previous syntheses.

And here Mr. Williamson seems to touch upon the quality in Donne which attracts the modern reader—the struggle of a man who "has awakened to the insufficiencies of previous syntheses" to establish not only a means of expression for his resultant state of mind, but a soul-satisfying solution to his problem. If Donne's world were "all in peeces" as a result of the work of the sixteenth and seventeenth century scientists, so is ours from a somewhat different cause. If Donne found, through intuitive perception, the interrelation and interdependence of men, we have had the fact thrust upon us with such brutal realism that its more mystical implications overtake us almost unawares, and, though the issue may not result for us in a triumph of faith, it must make ever more evident to us that primitive cry of men for a "sure refuge," and bring with it an increasing consciousness of the brotherhood of men. So the personality and works of John Donne take on a new meaning for his twentieth century readers "for whom the bell tolls."

No man is an Island, intire of it selfe; every man is a peece of the Continent, a part of the maine; if a Clod bee washed away by the sea, Europe is the lesse, as well as if a Promontorie were, as well as if a Mannor of thy friends or of thine owne were; any mans death diminishes me because I am involved in mankinde; and therefore never send to know for whom the bell tolls; It tolls for thee.—JOHN DONNE, "The Devotions," Section 17.

BOOKS ON SCIENCE FOR LAYMEN

MATHEMATICS MADE HUMAN¹

THIS is a highly successful popular presentation of certain ideas of modern mathematics. It departs from the usual trite popularizations of mathematics, whose purpose, as justly described by the authors, is "either to discuss [mathematics] philosophically, or to make clear the stuff once learned and already forgotten."

Each of the nine chapters either discusses some classical topic from a modern point of view, or deals largely with fairly new topics whose interest for mathematics as a whole has been appreciated only comparatively recently. All the topics selected amply sustain the authors' thesis that the imagination has played an important, sometimes decisive, part in the development of mathematics.

Avoiding the hack reviewer's pet cliché that "it is difficult to see for what class of readers the book is intended," we observe merely that it is not addressed to morons. There is something here for those who have gone no farther than counting in arithmetic; also something for those who have traveled so far that they are rather tired of mathematics, and wonder whether after all they would not have got more out of life by sharing a thoughtless peace of mind with their neighbors and the ever-tranquil cows. To the first class of readers the earlier chapters, leading from the simplest arithmetic to transfinite, transcendental and imaginary numbers, will be a revelation. Both classes will enjoy the chapters on topology, with their "rubber sheet geometry" and the incredible map described on page 297. An unscrupulous reader might take a considerable sum of money off his friends with that map. Nearly

¹ *Mathematics and the Imagination*. Edward Kasner and James Newman. xiv + 330 pp. \$2.75. 1940. Simon and Schuster, Inc.

every one will be interested in the exposition of probability, for only the very best of us (or the most intelligent) never gamble. Such topics as non-Euclidean geometry raise the controversial question of the relation of mathematics to truth. As this contradicts Hardy's creed of the (Platonic) realism of mathematics we quote a part of what the authors report.

"... we have overcome the notion that mathematical truths have an existence independent and apart from our own minds. It is even strange to us that such a notion could ever have existed. . . . To-day mathematics is unbound; it has cast off its chains. Whatever its essence, we recognize it to be free as the mind, as prehensible as the imagination."

Even though this humanized conception of mathematics may be blasphemy to some, it has the merit, unusual in mathematical philosophy, of making sense.

Though it is rather fatuous to wish this book (with its excellent typography, clear drawings and diagrams and full index) the success which it already has, we trust that it will have a long and prosperous career. It is something new, of its own kind, in the popularization of mathematics.

E. T. BELL

THE STORY OF ELECTRICITY¹

EVERY reader of this monthly knows the importance of electricity to-day and knows the names of its great pioneers—Edison, Brush and Elihu Thomson. But few know what colossal labors lie between an idea in the mind of an inventor and the convenient light on the desk or an electric locomotive. It was only sixty years from Thomson's day as a young instructor at the Boys' Central

¹ *Men and Volts*. John Winthrop Hammond. xii + 436 pp. \$2.50. 1941. J. B. Lippincott Company.

High School in Philadelphia to a corporation with assets of 323 million dollars, from the days of gas lights and horse cars to a complete electric age, but the story of that transition is an epic of science, engineering, finance, management—in fact of pre-war America. It is fully as interesting and important in American history as is the winning of the West.

Just to prove how much more than technical invention is involved it is worth mention that in the 48 years of its existence the General Electric Company has sold approximately seven billion dollars worth of products, has paid nearly three billions in wages and salaries and 656 millions in dividends, and has more than two hundred thousand stockholders, besides fathering the Radio Corporation of America and those discoveries in pure science which can not be measured in dollars.

The original manuscript of this great official history ran to 300,000 words and was based on more than three years of painstaking research. It carried the story to 1922. But John Hammond died in 1934 and Arthur Pound edited and condensed the record to about one third and added a brief epilogue to cover recent years. The final thirty pages are a formal statement by Owen D. Young on the formation of the capital of the General Electric Company made to the Temporary National Economic Committee in 1939.

Thus the record of the first thirty years forms the bulk of this book, the days of leadership by Charles A. Coffin and of E. W. Rice, Jr., the two first presidents, and of the technical pioneers, Edison, Thomson, Brush, Wood and Steinmetz. It is of such interest to readers of to-day that one must hope that a similar dramatic story is now being prepared of the days since then, under the direction of Owen D. Young and Gerard Swope and the ideas of Whitney, Lang-

muir, Alexanderson, Coolidge and the Research Laboratory. That is already material for history, for now the company faces a great world-crisis under its third generation of executives, with Philip D. Reed as chairman and Charles E. Wilson as president. It is a thrilling continued story, showing just why and just how knowledge is power—when used with intelligence.

GERALD WENDT

METEOROLOGY FOR AVIATORS¹

THE author's stated purpose of presenting such aspects of meteorology as are of importance to the aviator has been carried out successfully. Development of the subject-matter proceeds in a logical and orderly manner.

The first three chapters deal with the fundamental bases of synoptic work, namely, the collection of meteorological observations, instruments used and coding and charting of the observations. In chapters four to twelve are discussed pressure, temperature, humidity, density, visibility, atmospheric motions and condensation processes. Chapters thirteen to sixteen deal with air masses, convergence and divergence, frontal and other depressions and anticyclones and other pressure types. One of the most important parts is chapter seventeen, which treats of the practical phases of weather forecasting. Examples of synoptic situations presented in chapter eighteen are confined to the region of the British Isles which differ materially from American conditions, and leaves something to be desired for American readers. Chapter nineteen deals with the general circulation of the atmosphere and world climate; and the final chapter condenses the broad features of weather over the oceans and continents into remarkably small compass in a very satisfactory manner. That mathematics has

¹ *Meteorology for Aviators*. R. C. Sutcliffe. xiv + 276 pp. \$4.00. 1940. The Chemical Publishing Company.

been kept to a minimum consistent with the requirements will be appreciated by the average student. A large number of comments, associating weather with flying conditions, will be found of practical assistance in the field of aviation. Those undertaking for the first time work in weather forecasting from synoptic charts will find the book a helpful guide.

While the more important features of the book are excellent, exception might be taken to some less important ones. Warm and cold anticyclones could be made more complete by considering the vertical extent of the circulation as associated with the vertical temperature distribution. Some workers at least might find the definition of secondaries not to their liking, especially when the criterion of depth of pressure at the centers is employed. It is noted also that the author has followed other writers of recent years in the use of the term isallobars in restricting its use to three-hour pressure falls, instead of making it applicable to falls of pressure in any stated interval of time.

In all, the author's contribution is a quite valuable addition to the literature.

R. H. WEIGHTMAN

THE PROBLEM OF "SHELL-SHOCK"¹

DURING World War I, much was heard of the alliteratively titled disorder called "shell-shock," a term which included virtually all mental disorders in soldiers. (The term, by the way, had and has no medical standing in this country, and was not used officially). It was recognized by medical men that certain soldiers, particularly when exposed to concussion by high explosives, developed certain symptoms generally labelled "neurotic," that is, largely due to psychological factors with only a minimum of structural damage—these states in-

cluded, among others, hysterical paralyses, aphonia, tremors, stuttering, certain circulatory disturbances (effort syndrome) and anxiety states.

This group of so-called "functional nervous disorders" has not shown any tendency to decrease, thanks partly perhaps to the Government's very generous policy of paying compensation so long as the symptoms are retained. Indeed, even now, almost twenty-two years after the Armistice, over 35,000 veterans are being compensated for disorders of this type, at an average rate of about \$50 per month!

Now another war is on, a war in which American soldiers, sailors and civilians may sooner or later be engaged. We read of the "bomb shocked" children of England, and of the indiscriminate bombing of civilians under conditions in which the individual is hardly in a position to fight back at the enemy.

The present volume is a study of the mental mechanisms of what the author terms the "traumatic neuroses of war." There are 24 brief case reports, dealing with patients who have proved resistant to treatment. The author is a competent psychoanalyst who has devoted long study to the problem and who has been able to avail himself of the dynamic methods of studying cases. Many of the considerations are theoretical and primarily of interest to the psychopathologist rather than to the non-medical reader.

The author defines trauma as an "external factor which initiates an abrupt change in previous adaptation"—a rather broad definition, compared with the generally accepted usage! He further defines a traumatic neurosis as "a type of adaptation in which no complete restitution takes place but in which the individual continues with a reduction of resources or a contraction of the ego" (p. 79). Among the examples of "traumata" Dr. Kardiner lists such

¹The *Traumatic Neuroses of War*. Abram Kardiner. x+258 pp. \$3.50. 1941. Paul Hoeber, Inc.

discrepant moments as fatigue, a sudden pain, arteriosclerosis, skull fracture and brain tumor (p. 74). Such a wide range seems a bit inconsistent with describing the traumatic neurosis as a "highly specific syndrome" (p. 3)!

As for prognosis, the author is decidedly pessimistic, a fact perhaps attributable in part to his having observed only post-war patients and not having had actual combatant experience. Many rather "classical" cases occurring at the front during the World War (and in the present hostilities) cleared up promptly with relatively simple treatment. One can agree heartily with the author's arguments in favor of lump sum compensation for such cases, as against the instalment method—a method which all too often tends to superadd a "compensation neurosis."

The volume, which first appeared as a monograph in the Psychosomatic Medicine Series, represents a vast deal of study and thought on a most important topic. Whether or not one agrees with all the author's conclusions, it represents a valuable contribution to the literature, and should be read by every serious student of military psychiatry. A bibliography and index complete the volume.

WINFRED OVERHOLSER, M.D.

CULTURAL ANTHROPOLOGY¹

THE original edition of this work was prepared to communicate "an elementary knowledge of culture history" and to forestall "the long and needless floundering" which the author had observed among students of cultural anthropology and other social sciences. Its immediate success and wide utilization—including a French translation employed as a text in South America as well as in France—proved that Professor Lowie was not mis-

¹ *An Introduction to Cultural Anthropology*. Robert H. Lowie. 2nd edition. Illustrated. xxx + 584 pp. \$3.50. April, 1940. Farrar and Rinehart, Inc.

taken in his estimate of the need. The volume took its place at once in the front rank of such publications. At the same time teachers of anthropology expressed a strong desire to have it amplified in certain directions, including the introduction of chapters on language and theory, as well as descriptions of typical cultures in their totality. Indeed, Part I of this work is practically identical with the original except for the addition of the two chapters mentioned, the increase from 365 to nearly 600 pages being due mainly to the introduction of case studies of nine typical cultures, though there is appended also a useful glossary of terms and a selected reading list.

The nine studies just mentioned perform the same function to Part I as a treatise on physiology in supplementing one on anatomy or as synthesis in grammar complements analysis. Discussions of material culture, social, esthetic and religious manifestations in general are, after all, dissections of the total life of a people. Industries, arts, social adjustments and relations to the cosmos, seen and unseen, do not exist in separate compartments. They function side by side, or rather confluent, in the very same human brains, and the differences which they manifest in different peoples are not merely variations in industries, arts, customs, institutions and beliefs *per se*, but variations in complexes of those activities and attitudes. Hence the importance of the studies which Professor Lowie has added to his new edition, and it must be said that they have been excellently selected and admirably epitomized in the necessarily limited space assigned to each.

It was evidently Professor Lowie's intention to show at one and the same time the diversity of human cultural expressions and the thread of unity running through them all. Forbearing to include a sketch of the Crow Indians on which he has written extensively, Professor

Lowie has chosen two tribes from South America, one from North America, one from Australia, one from Africa, one each from Indonesia and Melanesia, one from Asia and one from Europe. Three of these may be said to illustrate cultures generally considered among the lowest or "most primitive," four may be described as intermediate, and the Asiatic and European examples bring us to the cultural, as well as the historical, vestibule of what we generally call "civilization." Selection of the Albanians furnishes a clever means of tying up all these with the "higher peoples" of western Europe, including ourselves, and to "Our Western Civilization" is directed a short, pithy apostrophe which may be said to point the moral of the cultural story—in no moralizing tone, however, but with the breadth of view, temperance and dignified restraint so characteristic of its author. Those who are familiar with Dr. Lowie's more popular volume "Are We Civilized?", a work deserving the distinction of a best seller among those who use their minds for some other purpose than to feed a preconception, will recognize the same spirit. His discussion of racialism is particularly timely and should prove convincing to all readers not eaten up with prejudice and oblivious to argument.

This is a work which may, and should, "introduce" cultural anthropology to many outside of the academic halls as

well as those within them for whom it is particularly intended.

JOHN R. SWANTON

AMERICAN SNAKES¹

ALL America is divided into three parts, according to Ditmars' arrangement of the snakes. The work is really three handbooks in one. After a short reptile survey, an account of the habits and instructions for identifying snakes, come a chapter each on the northeastern, the southeastern and the western species, with simple, non-technical keys for identification and descriptions of each species, with notes on habits and distribution.

Identification of the species is greatly facilitated by a series of 48 plates with diagnostic photographs. These, partly the work of Ditmars himself and partly of his colleagues, are excellent. The treatment of snake bites, both in humans and domestic animals, is considered in an informative and broad-minded manner. The classified list of the snakes in North America includes scientific and common names and the distribution.

In general, this is a most useful book for the field naturalist and student of reptiles.

W. M. MANN

¹ *A Field Book of North American Snakes.* Raymond L. Ditmars. xii + 305 pp. 48 plates. \$3.50. 1939. Doubleday, Doran and Company, Inc.



DR. ARTHUR H. COMPTON

**CHARLES H. SWIFT DISTINGUISHED SERVICE PROFESSOR OF PHYSICS, THE UNIVERSITY OF CHICAGO;
PRESIDENT-ELECT OF THE AMERICAN ASSOCIATION FOR THE ADVANCEMENT OF SCIENCE.**

THE PROGRESS OF SCIENCE

NEWLY ELECTED PRESIDENT OF THE AMERICAN ASSOCIATION

IN electing Professor A. H. Compton to the presidency of the American Association for the Advancement of Science, the association becomes headed by one typically representative of that reincarnation which physics experienced at the birth of the quantum theory.

Three decades ago classical spectroscopy, one of the most dignified representatives of formal empiricism, guarded carefully in the etiquette of scientific procedure by some of the most distinguished lights of the day who had no great love for speculation, was struggling in its bonds to participate in the feast of good things which the experimentalist was continually bringing forth from his investigational oven. The Bohr theory arrived, and all good physicists, who, at the time, were over half a century in age, while admiring the genius of the young upstart who had brought it forth, grumbled nevertheless among themselves and voiced strong fears concerning the road to intellectual ruin which their beloved science seemed to have taken. Photoelectricity had demanded a strong break with that past and the effect, whose discovery was Compton's first claim to fame—the Compton effect—marked the beginning of the new era in which the quantum theory sought satisfaction in its own laws rather than in some vague peculiarity of classical theory.

It was in 1931 that Compton entered a relatively new field by undertaking a geographical survey of the cosmic ray intensity, as a result of which a latitude effect, which had already been claimed by J. C. Clay, became confirmed by a very extensive set of observations. The result was that this effect, which formerly had only been partially accepted,

became a fundamental element in the discussion of the nature of cosmic radiation.

Arthur H. Compton was born at Worcester, Ohio, on September 10, 1892. He received his B.S. degree from Worcester College in 1913 and his Ph.D. from Princeton in 1915. He became a member of the faculty of the University of Minnesota in 1916, and research physicist for the Westinghouse Lamp Company in 1917. In 1919 he went to Cambridge, England, for a year. He became professor of physics and head of the department at Washington University in 1920, and in 1923 he was elected professor of physics at the University of Chicago. He has countless medals, honorary degrees, and other distinctions to his credit, including the Rumford Gold Medal of the American Academy of Arts and Sciences, the gold medal of the Radiological Society of North America, the Matteucci gold medal of the Italian Academy of Sciences and the Franklin Institute gold medal. He was awarded the Nobel Prize for Physics in 1927. He is a member of numerous scientific societies, including the American Physical Society, of which he was president in 1934, the American Philosophical Society and the National Academy of Sciences.

In addition to his multitudinous activities as a physicist, Compton finds time to participate in the social activities of his community, particularly those associated with the church. He is a man of strong athletic build and can put up a hot game of tennis at any time.

A delightful friend and a man of broad interests, he should provide the American Association with a president well calculated to represent its best traditions.

W. F. G. SWANN

THE AMERICAN ASSOCIATION—AN INTEGRATING AGENCY IN SCIENCE

PERHAPS the most distinctive and important function of the American Association for the Advancement of Science is to serve as an integrating agency in the ever-increasing specialization in science. Never has the value of this function been more emphatically illustrated than during the meeting it held in Dallas, Texas, from last December 29 to January 3.

Dr. Albert F. Blakeslee, retiring president of the association, took for the title of his presidential address "Individuality and Science." In announcing this subject a year ago he proposed a general theme, a *leit motif*, that he hoped would appear again and again in the program, as it did. It emphasizes the distinctiveness of the individual, whether it be on the human level or that of the lowliest organism, or in the snowflake or other crystal. It is a universal characteristic of the units with which science is concerned and adds dignity to the individual in spite of similarities which are at the

basis of science. It is a unifying generality derived from individual diversities.

Many less sweeping integrations were made in the 193 sessions which were held for the delivery of addresses and the presentation of papers, of which there were 1,436 in the few crowded days of the meeting. The most conspicuous were the symposia in which a number of distinguished authorities joined in discussing the various aspects of some broad field of science and set forth a unified whole which in importance and comprehensibility is much greater than the sum of its parts. It is such integrations that the association has published in its symposia volumes which have been on such subjects as cancer, mental health, human malaria and the heart, to mention only a few in the field of public health.

There is a reason why the mingling of men of somewhat different points of view is important. Excessive specialization leads to sterility, whether it be in the

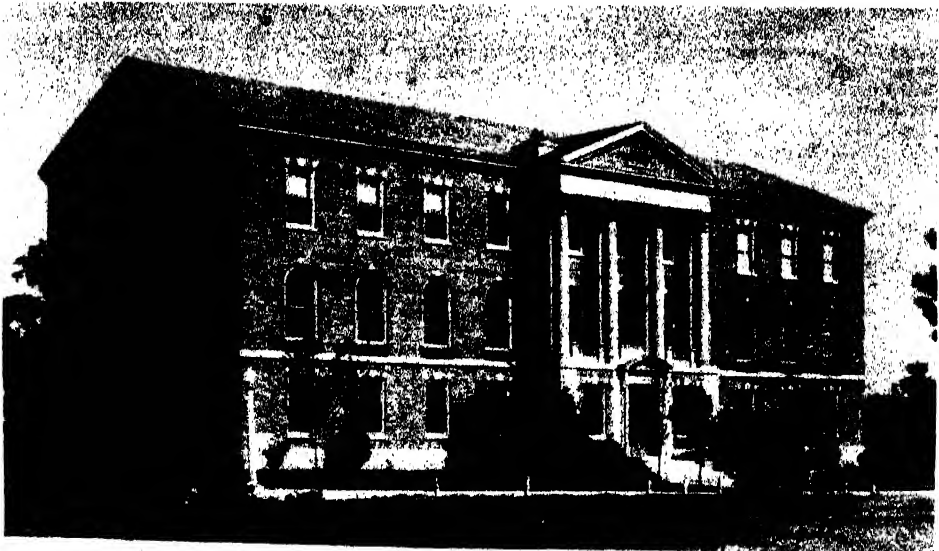

HYER HALL OF PHYSICS OF THE SOUTHERN METHODIST UNIVERSITY
WHERE SOME OF THE PHYSICS AND ASTRONOMY SESSIONS WERE HELD; SEVERAL ASSOCIATED
SOCIETIES ALSO MET IN THIS BUILDING.

field of living organisms or in the field of ideas. Often highly specialized plants, as apple trees, for example, are incapable of fertilizing their own blossoms, and to produce fruit must obtain pollen from other and often inferior varieties. How often has a somewhat similar thing happened in a culture or a philosophy or a religion! Decadence is overspecialization. The hundreds of thousands of extinct species of plants and of animals are probably mostly examples of it.

The American Association for the Advancement of Science brings together specialists from practically all the broad fields of the natural and the social sciences. Its fifteen sections organize varied programs and its 186 affiliated and associated societies represent many points of view and specialized interests. If any one over-values his own subject in such an environment, he is likely to get his bias corrected. If he is unaware of the broad currents that are sweeping along in fields other than his own, he is likely to be enlightened. If he is groping for unifying ideas in his specialty, he stands a good chance of discovering a clue to them in some related subject.

In addition to these fortuitous fruitful contacts that are always highly valued by those who attend meetings of the association, there are the deliberately planned joint programs of related sections and societies. Sometimes groups that are clearly related in interests meet together. For example, the zoologists and the botanists united at Dallas in discussing the effects of temperature on evolution. In other cases scientists with generally quite different interests find that special sectors of their fields are complementary. For example, at Dallas the Section on Geology and Geography, the Geological Society of America and the Section on Anthropology united in a symposium on "Early Man." Some-

times a number of different societies unite in considering a subject of almost universal interest, as when the Botanical Society of America, the American Society of Naturalists, the American Society of Zoologists and the Genetics Society of America joined in a symposium on "Human Genetics." In the subject of genetics, perhaps more explicitly and illuminatingly than in any other, are the common properties of all life, whether plant or animal, brought into the light. Under the broadening effects of contemplating such unities in the organic world the pages of the history of the earth are turned back across the geologic ages to the ancient origins of the streams of life which have come down to our day. In such reflections the scientist acquires both humility and serene dignity, for he realizes that he is not some darling of the gods but an evolving organism to whose future

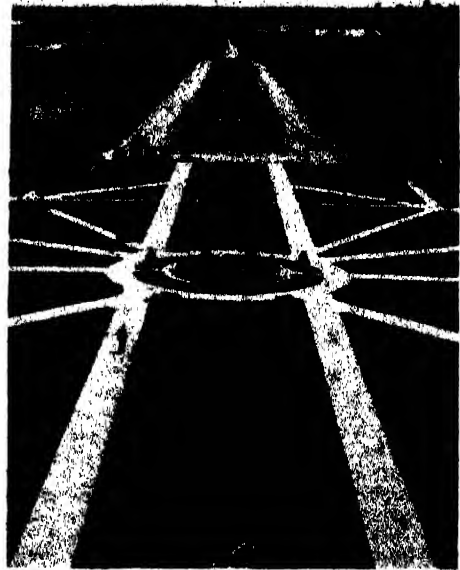

CENTRAL CAMPUS QUADRANGLE
AT SOUTHERN METHODIST UNIVERSITY WITH THE
DALLAS SKYLINE IN THE BACKGROUND.

achievements no limits can be set. He daily increases his understanding of the general processes of evolution and even aspires to mark out, perhaps in a still

distant future, a glorious pathway that his successors may follow.

F. R. MOULTON,
Permanent Secretary

THE AMERICAN ASSOCIATION PRIZE FOR 1941-1942

THE award of the A.A.A.S. prize for 1941-1942 to Drs. Frank H. Johnson, Dugald E. S. Brown and Douglas A. Marsland is a happy example of the results which can be attained by cooperation in somewhat diverse fields. Ever since Dr. Johnson's graduate student days at Princeton, he has been an enthusiastic and painstaking student of luminous bacteria. He has studied their food requirements, their respiration and their luminescence as affected by temperature, narcotics and various poisons. He has become an expert in culturing them, measuring their light intensity and interpreting the complicated series of reactions which are responsible for the luminescence. He is now assistant professor of microbiology at Princeton University.

Drs. Brown and Marsland have long been associated in the study of the effects of high pressures on various cells and cell processes. These studies have had to do with muscle contraction, amoeboid movement, cell division and the viscosity of cells. In the investigation of these processes they have perfected many ingenious devices for observing and recording under high pressure. Dr. Brown is professor of physiology and Dr. Marsland, assistant professor of biology at New York University.

It is surprising that so little attention has been paid to living cells under pressure, since pressure is just as important as temperature in defining a chemical equilibrium. Since the early experiments of Regnard in 1884, which were stimulated by the dredging expedition of the ship *Talisman*, that found living animals at great depths, practically no

work on pressure has been carried out until Edwards and Cattell in 1927 began their series of observations on the heart and cardiac function. Since then pressure has become increasingly important in biology, largely through the notable discoveries of Brown and Marsland.

A most necessary procedure in biological research is to select the proper material. One of the great advantages of luminous bacteria is the opportunity they offer to follow a chemical reaction in the living cell without removing samples from time to time for analysis. This is because the light intensity of the bacteria is a measure of reaction velocity, the rate at which a chemical reaction proceeds. We have in these bacterial test-tubes a series of reactions whose rate can be automatically and continuously followed by recording the luminescence. The primary reaction is the oxidation of a substance, luciferin, by the enzyme, luciferase. Like every other chemical reaction, this light-emitting one proceeds faster as the temperature rises, but soon a certain temperature is reached where it slows, and as the temperature rises still further the rate (*i.e.*, light intensity) becomes less and less and finally practically ceases. If the temperature is now lowered, the light again returns. The temperature effect is reversible within certain limits.

However, a striking thing happens if the hydrostatic pressure is increased at a temperature where the light has been considerably dimmed. The luminescence increases and returns to practically its original brightness without lowering the temperature. The pressures which do this are not super-pressures, such as

occur in stars or even the highest pressures attainable in the laboratory, but a mere 5,000 pounds per square inch such as occurs two miles deep in the ocean, where many shrimp and fish live permanently.

This effect of temperature and pressure on luminescence can be explained by an effect on two chemical processes, the increase in velocity of the luciferin-luciferase reaction with increase in temperature and the reversible denaturation of the enzyme luciferase as the temperature rises. In this reversible denaturation the luciferase molecules become larger. Pressure restores them to their original size; it reverses the denaturation equilibrium and the original luminescence intensity returns. These changes are without doubt applicable to practically all biological effects of temperature and follow from the newer knowledge of absolute reaction rates, predictable from quantum mechanics by the work of Eyring and his collaborators.

A second remarkable finding of the A.A.A.S. award group has to do with the effect of pressure on the narcosis of

luminous bacteria. The light of luminous bacteria which has been nearly quenched by some such narcotic as ether, chloroform or procaine can be restored again by increasing the pressure. The explanation is the same as that for the effect of temperature, a reversible denaturation of the luciferase by the narcotic which again involves an increase in molecular volume. Pressure restores the original volume. This finding is also of general importance and applicable to narcosis of nerve cells and other types of biological activity.

These brief statements give an idea, all too inadequate, of the basic goal of Johnson, Brown and Marsland, the use of luminescence, temperature and pressure to analyze cell reactions. Although luminescence is the function actually studied I should like again to emphasize the wide significance of their results. Biologists in all fields will join in extending hearty congratulations to the prize winners along with the hope that they will continue to apply these tools to the further elucidation of life processes.

E. NEWTON HARVEY

ENGINEERING AND INDUSTRIES SECTION OF THE NEW "INDEX EXHIBIT" OF THE SMITHSONIAN INSTITUTION

THE semicircular alcove of Cultural Anthropology described in the December, 1941, issue of the *SCIENTIFIC MONTHLY*, faces a similarly shaped alcove devoted to engineering and industries. This part of the exhibit illustrates the work of the engineering and industrial divisions of the National Museum. These divisions, aside from maintaining popular educational exhibits, have the function of preserving adequate collections of original machines, inventors' models, and experimental mechanisms which trace the progress of our industries and our machine economy.

The theme center of the alcove calls attention to the impact upon the world's social and economic pattern made by the large-scale use of the energy resources of fuels and water power. It shows rulers commanding the energy of hordes of toiling slaves to build the pyramids and by way of contrast a handful of skilled operators directing mechanical or electrical energy into the machines by which they are building structures surpassing the pyramids in volume alone. The modern structures shown are dams which will in turn produce more hydro-electric energy to free more people from back-

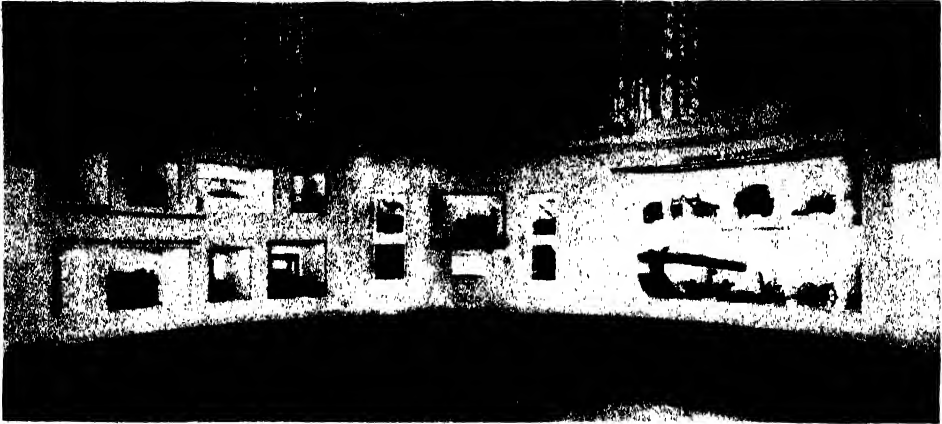

THE ENGINEERING AND INDUSTRIES ALCOVE
OF THE SMITHSONIAN INSTITUTION'S INDEX EXHIBIT. TO THE LEFT ARE EXAMPLES OF CREATIVE
AND INTENSIVE INVENTIONS. THE LARGE MODEL IN THE CENTER IS OF THE NEWCOMEN STEAM
ENGINE. TO THE RIGHT ARE EXAMPLES OF INVENTIONS IN AGRICULTURE.

breaking toil and give them the relative freedom of working with their minds and skills. Between these illustrations is an operating model of the machine which was practically the original instrument to inaugurate the application of fuel energy to mechanical work—the Newcomen steam engine of 1712. Its timbered walking beam jerks through the motion of lifting the rods of pumps rais-

ing water from an English coal mine. The original engine was the first machine capable of putting to work the energy released from any considerable amount of fuel. A contemporary model of the Newcomen engine was James Watt's introduction to the elementary problems of efficiently using the power of steam which he so ably solved. It is difficult to overestimate the importance of the Newcomen engine in the recent history of the world.

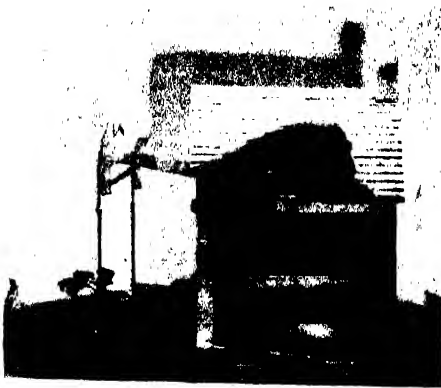

NEWCOMEN STEAM ENGINE OF 1712
THE ENGINES AND MACHINES THAT HARNESS THE
ENERGY RESOURCES OF THE EARTH BEGAN AS SIM-
PLY AS THIS EARLY STEAM ENGINE.

In times of unrest, particularly during economic disturbances, much criticism is directed at the inventor and the engineer for their parts in the development of machines and processes that displace the laborer and craftsman. Without direct reference to this question or its answer, two groups of original models and actual old devices representing inventions are displayed. One group represents the creative inventions which have created vast new industries and multiplied the opportunities for employment many times. These include an original Armat motion picture projector, the patent model of the Selden automobile, a model of the Wright airplane of 1903, and the

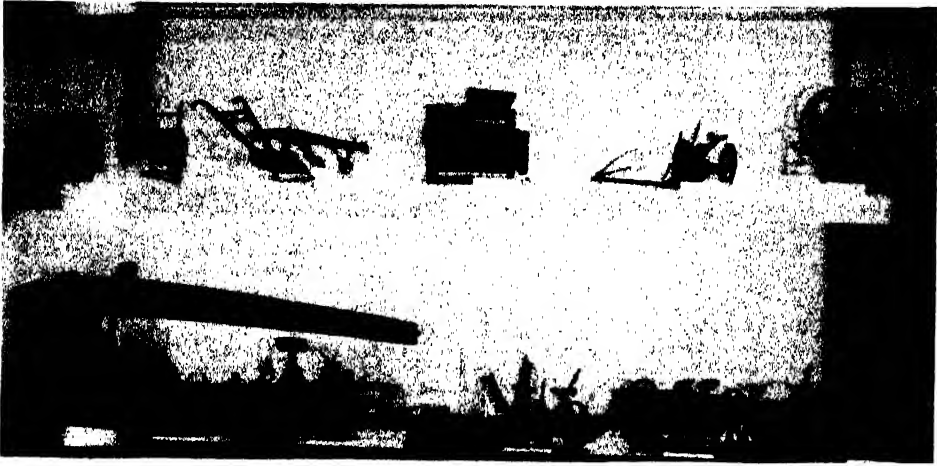

INVENTIONS IN AGRICULTURE

Top, ORANGE-SIZING APPARATUS (1881); GRAIN DRILL (1882); SUPPORTER FOR STEEL PLOW (1877); VEGETABLE SORTER (1879); MOWING MACHINE (1878); STRAW CUTTER (1878). *Bottom*, STEEL PLOW (1838); CORN PLANTER (1861); GRAIN HARVESTER (1878); GRAIN DRILL (1879); SULKY CULTIVATOR (1891).

patent model of the Sholes, Glidden and Soule typewriter of 1868.

The second group represents the so-called intensive inventions. These are the tools that have multiplied the productive capacity of the individual, and

though they have immediately displaced workers, they have often lowered costs so much that consumption has increased greatly enough to require a greater employment to accomplish the necessarily increased production. These include an

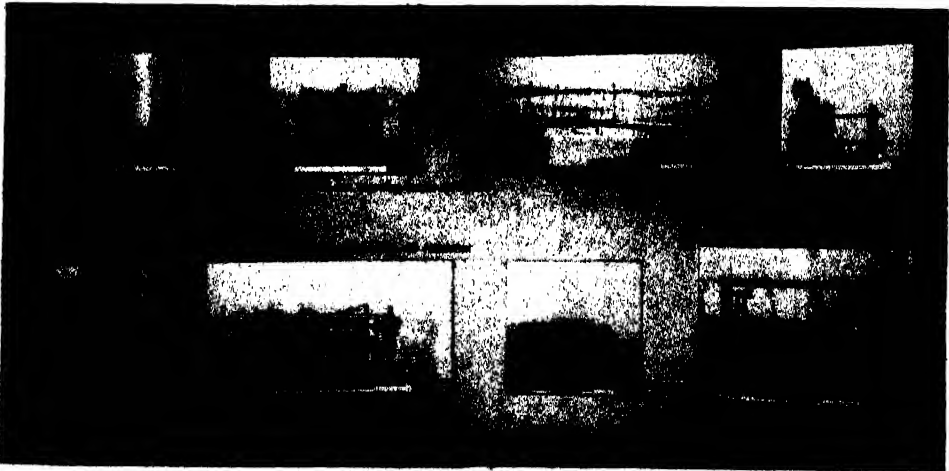

EXAMPLES OF CREATIVE AND INTENSIVE INVENTIONS

Top, SOME OF THE CREATIVE INVENTIONS, WHICH MAKE NEW PRODUCTS AND INDUSTRIES AND CREATE EMPLOYMENT: SELDEN AUTOMOBILE (1879-1895); SHOLES TYPEWRITER (1868); WRIGHT AIRPLANE (1903); ARMAT MOTION PICTURE PROJECTOR (1897). *Bottom*, SOME OF THE INTENSIVE INVENTIONS, WHICH LOWER COSTS AND INCREASE CONSUMPTION AND PRODUCTION.

original Thomson electric welder, Howe's own model of his sewing machine, the G. Crompton loom and the Blanchard copying lathe.

These groups are exhibited in two parallel rows of small openings on one side of the alcove. On the opposite side is a large group of models representing the application of the machine to a field classically associated with hard human labor, namely—agriculture. In this case the original Deere plow of 1838 stands in

somewhat battered simplicity in contrast with the nicely finished patent models of more complicated agricultural tools. These include a fruit sizer, a vegetable sorter, harvesters, mowers and many other machines that now, in combination with the internal combustion engine and the rural electric power line, are extending the advantages of the nation's energy resources to the farmer.

FRANK A. TAYLOR

MEDICAL-PHYSICS LABORATORY OF THE UNIVERSITY OF CALIFORNIA

A MODERN research plan, designed for greater cooperation than ever before among scientists trained in many specialized fields, is being developed at the University of California to explore the promising new fields by the atom-smashing cyclotron. To carry out this plan, the first medical-physics laboratory in the world will be built on the Berkeley campus, and a five-man team of scientists will form the nucleus of a unique new research division.

The plan is a recognition that the body of scientific knowledge is becoming so

great and the various branches so closely interwoven that one man can not possibly cope with all the problems he will encounter in a single complex experiment. With the new facilities being provided, the university will make it possible for from ten to fifty specialists to concentrate on a single problem at one time. The new laboratory will represent a union of physics and medicine and other branches of science, such as chemistry, bacteriology, biology and genetics.

The new laboratory will intensify experimental work in the vast new fields

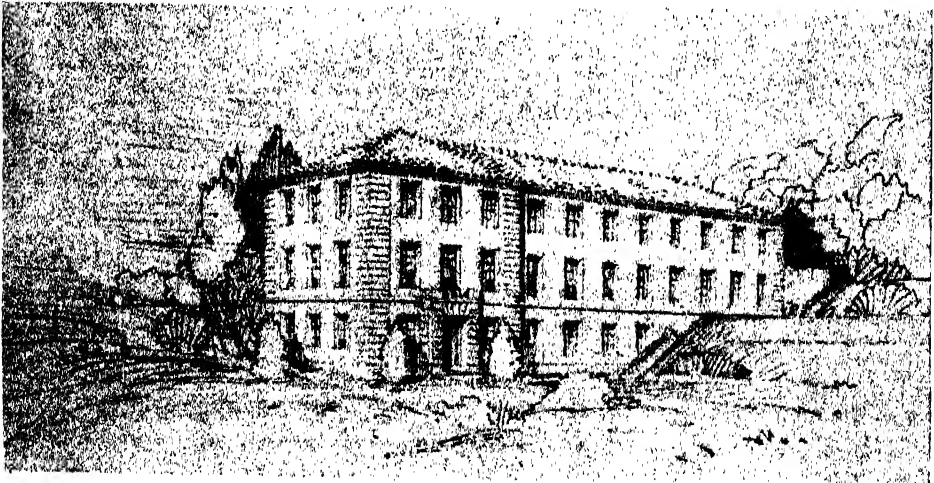

ARCHITECT'S DRAWING OF THE NEW MEDICAL-PHYSICS LABORATORY
THE BUILDING WILL BE DEVOTED ENTIRELY TO RESEARCH WORK.

of science opened by the cyclotron, such as the study, with radium-like substances, of the normally functioning living body and the manner in which it absorbs foods; the investigation of the causes of various diseases, including cancer and leukemia, with radioactive substances and with the neutron beam produced by the cyclotron; the exploration of rudimentary life processes, including photosynthesis, the method by which green plants store the energy necessary for life on earth, and, cell division, or elementary reproduction.

The research program will be made possible by two important donations reported recently by the president of the University of California, Robert Gordon Sproul: First, a gift of \$165,000 to build and equip the building from the International Cancer Research, of which M. W. H. Donner is president. Second, a contribution of \$50,000 from the Columbia Foundation of San Francisco to support for five years a five-man research team. Support by the Columbia Foundation will enable the university to organize and keep together for the first time a group of workers in the new field of medical physics.

The research plan is being mapped by Dr. John H. Lawrence, who is in charge of medical investigations with the cyclotrons on the Berkeley campus. He will apply the instrument invented by his brother, Professor E. O. Lawrence, Nobel Prize winner, to medicine and biology.

The new sciences developed by the cyclotron call for close cooperation of men highly trained in a number of fields. To make possible a more effective combination of this scientific training, the new laboratory of medical physics will have specialized facilities for all in one building.

The Medical Physics Laboratory will be devoted entirely to experimental research. No treatment will be carried on there. Facilities will include chemical,

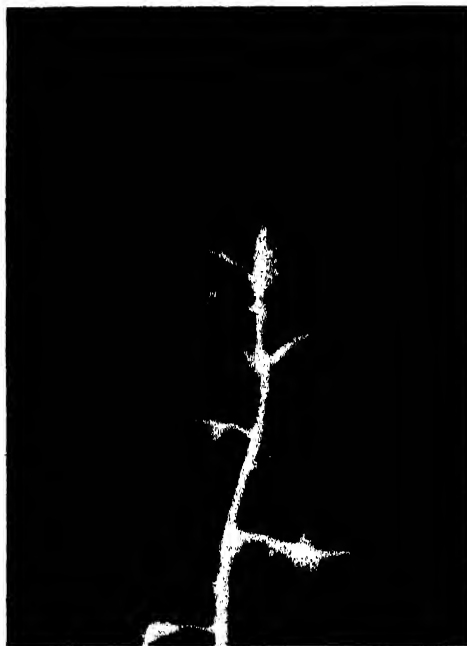

RADIOGRAPH OF LEAVES AND STEM OF A TOMATO PLANT WHICH HAD PREVIOUSLY TAKEN UP RADIOACTIVE PHOSPHORUS AS DISODIUM PHOSPHATE THROUGH THE ROOTS. THE PHOTOGRAPHS WERE TAKEN BY DR. PERRY STOUT.

physical, biological and biochemical laboratories, three dark rooms, an incubator room, a tissue culture laboratory and two underground rooms where delicate measurements of radioactivity can be carried out with electroscopes, Geiger counters and electrometers.

The entire second floor, except for a library and a seminar room, will be turned over to physicists who will be working with the giant 4,900-ton cyclotron now being constructed on the Berkeley campus.

The building will have 16,000 square feet of floor space and will be 45 feet wide and 160 feet long. It will be situated just north of the mining building on the University Campus, its main entrance opening to the south and another entrance opening on Gayley Road.

Support for the five-man research team

will begin next July 1. This unit will consist of a clinical investigator, Dr. John H. Lawrence, assistant professor of medicine; a radiologist, Dr. Robert S. Stone, professor of roentgenology in the Medical School; a medical chemist, Dr. Joseph G. Hamilton, research associate in the Radiation Laboratory and clinical instructor in neurology in the Medical School; an animal biologist and geneticist, Dr. Alfred G. Marshak, research associate in the Radiation Laboratory; and a physicist trained in biology, Dr. Paul C. Aebersold, research associate in roentgenology and research associate in the Radiation Laboratory.

The primary tools in the new experimental program will be the radioactive substances produced by smashing atoms in the cyclotron. These substances are said to be the most valuable research tool since the development of the microscope.

Radioactive elements have all the ordi-

nary properties of their stable counterparts in the periodical table, except that their atoms explode eventually, emitting a ray. Therefore the radioactive atoms, until the moment of their disintegration, are used in chemical reactions and by the human and animal body just as ordinary elements are used. For example, the body uses radioactive sodium precisely as it uses ordinary sodium. The atoms of ordinary molecules can not be followed individually, but the radioactive elements act as beacons for the investigator, for distribution in the body can be traced by sensitive instruments which record the exploding atoms.

Radioactive elements are called isotopes of ordinary elements. More than 360 have been produced, and more than 100 of these were discovered in the University of California Radiation Laboratory. About a score of them have proved valuable in biological studies.

No previous method has been available for tagging the elements and compounds used by normal living organisms, and as a result, definite knowledge about metabolism was only fragmentary. Possibilities opened up by radium-like substances produced in the cyclotron are limitless. Already researchers at the University of California and in other laboratories have demonstrated that some of the accepted theories of body function were erroneous.

The three dark rooms in the new building will be used principally for taking radio-autographs; these "self-photographs" are employed to demonstrate the distribution of radioactive elements in the tissues of animals and plants. In this technique the animal is fed a radio-element, sacrificed, and the tissue in which the distribution of a radio-element is to be determined is placed on a photographic plate. The exploding atoms expose the film, and thus is secured a picture of the actual distribution of the

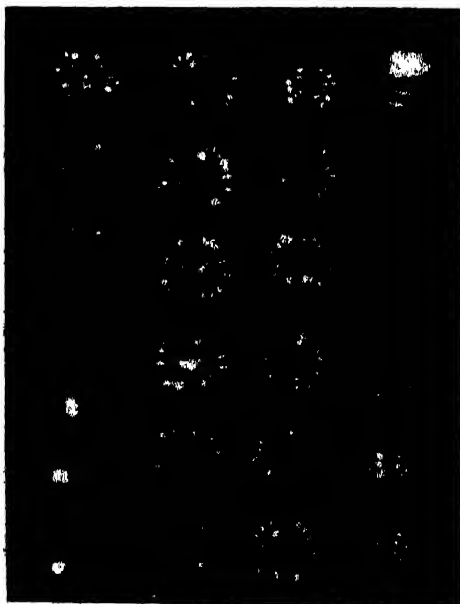

THIN SLICES OF TOMATO FRUIT
A SERIES OF RADIO-AUTOGRAPHS FROM A TOMATO
PLANT WHICH HAD PREVIOUSLY ASSIMILATED A
COMPOUND OF RADIATED ZINC.

tagged element or compound in the tissues.

Representative of the Berkeley Radiation Laboratory's accomplishments with tagged atoms are the following: It has been demonstrated that the enzymes of the body break down minerals and other food components much faster than had previously been supposed. For example, calcium is found in the milk of cows within a few minutes after the mineral is consumed; formerly it was assumed that this process took days. Long standing theories of plant nutrition have been refuted. Plants can draw food directly from soil particles; the food does not need to be dissolved into a solution.

By using radioactive carbon it has

been shown that plants can take up carbon dioxide without the presence of light. Radioactive strontium, a substitute for calcium, has enabled the Berkeley scientists to study the growth of teeth and bones and the migration of calcium from the mother to the offspring. Many unsolved problems surrounding the metabolism of the thyroid gland have been solved by the use of radioactive iodine. The metabolism of single cells is being studied with radioactive salts.

The new laboratory will make possible more extensive studies into the causes of disease such as cancer and leukemia, and further the development of new treatments for various diseases using irradiation methods.

JOSEPH G. HAMILTON

THE WORK AND PERSONALITY OF WALTHER NERNST

I ACCEPT with pleasure the invitation of the editors of this magazine to dedicate a few lines to the scientific personality of Dr. Walther Nernst, who died recently. For he was one of the most characteristic and most interesting scholars with whom I have been closely connected during my life. He did not miss any of the conferences on physics in Berlin, and his brief remarks gave evidence of a truly amazing scientific instinct combined both with a sovereign knowledge of an enormous volume of factual materials, which was always at his command, and with a rare mastery of the experimental methods and tricks in which he excelled. Although sometimes goodnaturedly smiling at his childlike vanity and self-complacency, we all had for him not only a sincere admiration, but also a personal affection. So long as his egocentric weakness did not enter the picture, he exhibited an objectivity very rarely found, an infallible sense for the essential, and a genuine passion for knowledge of the deep interrelations of nature. But for such a pas-

sion his singularly creative productivity and his important influence on the scientific life of the first third of this century would not have been possible.

He ascended from Arrhenius, Ostwald and Van't Hoff, as the last of a dynasty which based their investigations on thermodynamics, osmotic pressure and ionic theory. Up to 1905 his work was essentially restricted to that range of ideas. His theoretical equipment was somewhat elementary, but he mastered it with a rare ingenuity. I refer, for instance, to the theory of electromotive powers in solutions of locally variable concentration, the theory of diminution of the solubility by adding a dissolved substance. During this period he invented the witty null-method of determining the dielectric constant of electrically conducting bodies by means of Wheatstone's Bridge (alternating current, telephone as indicator, compensating capacity in comparison-bridge branches).

This first productive period is largely concerned with improving the methodology and completing the exploration of a

field the principles of which had already been known before Nernst. This work led him gradually to a general problem which is characterized by the question: Is it possible to compute from the known energy of the conditions of a system, the useful work which is to be gained by its transition from one state into another? Nernst realized that a theoretical determination of the transition work A from the energy-difference U by means of equations of thermodynamics alone is not possible. There could be inferred from thermodynamics that, at absolute zero, the temperature of the quantities A and U must be equal. But one could not derive A from U for any arbitrary temperatures, even if the energy-values or differences in U were known for all conditions. This computation was not possible until there was introduced, with regard to the reaction of these quantities under low temperatures, an assumption which appeared obvious because of its simplicity. This assumption is simply that A becomes temperature-independent under low temperatures. The introduction of this assumption as a hypothesis (third main principle of the theory of heat) is Nernst's greatest contribution to theoretical science. Planck found later a solution which is theoretically more satisfactory; namely, the entropy disappears at absolute zero temperature.

From the standpoint of the older ideas on heat, this third main principle required very strange reactions of bodies under low temperatures. To pass upon the correctness of this principle, the methods of calorimetry under low temperatures had to be greatly improved.

The calorimetry of high temperatures also owes to Nernst considerable progress. Through all these investigations, as well as through many stimulating suggestions with which his untiring inventive genius supplied experimenters in his field, he promoted the research work of his generation most effectively. The beginnings of the quantum theory were assisted by the important results of those caloric investigations, and this especially before Bohr's theory of the atom made spectroscopy the most important experimental field. Nernst's standard work, "Theoretical Chemistry," offers, not only to the student but also to the scholar, an abundance of stimulating ideas; it is theoretically elementary, but clever, vivid and full of intimations of manifold interrelations. It truly reflects his intellectual characteristics.

Nernst was not a one-sided scholar. His sound common sense engaged successfully in all fields of practical life, and every conversation with him brought something interesting to light. What distinguished him from almost all his fellow-countrymen was his remarkable freedom from prejudices. He was neither a nationalist nor a militarist. He judged things and people almost exclusively by their direct success, not by a social or ethical ideal. This was a consequence of his freedom from prejudices. At the same time he was interested in literature and had such a sense of humor as is very seldom found with men who carry so heavy a load of work. He was an original personality; I have never met any one who resembled him in any essential way.

ALBERT EINSTEIN

THE SCIENTIFIC MONTHLY

MARCH, 1942

FORCES AND ATOMS THE WORLD OF THE PHYSICIST

By Dr. KARL K. DARROW

PHYSICIST, BELL TELEPHONE LABORATORIES; WILLIAM ALLAN NELSON PROFESSOR
OF PHYSICS, SMITH COLLEGE, 1941

ONE of the signs whereby a physicist may be known is a fondness for putting dots upon blackboards. This is not an irrational habit, but a symbolic practice. It is a symbol of his manner of regarding the world as a multitude incredibly enormous of particles incredibly small. The dots stand for the particles, and the bare regions of the blackboard for the empty spaces between them. The habit has not indeed been universal. Many a thinker has preferred to consider the world as a continuum, a solid or jelly or fluid; and we shall see that this alternative has always been very near in the background, even when the "atomists" were at their most triumphant. Let me, however, defer this other idea, and derive as much as possible from the notion of particles in a void.

But when the dots are set down on the otherwise clean board with regions of black emptiness between, the story is far from completed. It is, in fact, only begun, for the major part is yet to be written: the account of the forces among the particles. Though these last be separated from each other by spaces apparently empty, yet they are not unconscious of each other, for each of them is subject to a force—the resultant of many forces, due to all the rest.

One might attach an arrow to each dot, to signify the strength and the direction of the force which acts upon it. One

might draw wandering curves all over the board, to intimate at every point the direction and strength of the force which a particle would feel, were it to be at that point. This is accepted practice, but it would be worth the doing only if our assumptions and our ambitions were much more specific than for the present they are. Perhaps at least the blackboard should be smeared with a uniform coating of chalk, to signify that a particle in space is not left entirely to itself, but feels the influence of the others. Among our not-so-distant ancestors there seems to have been a psychological need for a gesture of the sort; they talked about space as though it were filled with a "medium" or "aether," because it seemed wrong to them to say that space is empty if the particles which wander in it are subject to forces. Our generation has nearly lost the need, whether of an aether to occupy actual space or of a smear of chalk to symbolize it on the blackboard. Let us say that space is empty and leave the blackboard black between the dots, without deeming ourselves deprived of the right of saying that the particles exert and suffer forces on and from one another.

What is there to be said about the forces? A very great deal! for most of theoretical physics is made up of beliefs or ideas about the forces, augmented by the mathematical operations—very hard

and very long-winded, in far too many cases—required for making the ideas really useful. So great a program is indicated by that sentence, that I am wasting words in adding that it will not be fulfilled in one or two lectures, nor in the whole of the course. Only the most general of statements can be made in what follows. Of these I lay down at once the first, which is negative and self-evident:

The forces can not be purely repulsive. For if they were, all the particles would rush off into the uttermost depths of space, and we should have no model at all for a universe which, with all its faults, does manage at least to stick together.

Therefore there must be attractive forces, and these by and large must overpower the repulsive ones, if any such there be.

But need there be any repulsive forces at all? (Let the sophisticated reader now forget for a little that there are electrical forces which are repulsive, so that he may inquire with an open mind as to whether such could be avoided.) At first, it may not seem so; and one may invoke the great authority of Newton, who is often thought to have contented himself with assigning to all bodies the power of attracting one another with the force of gravity. He did not so content himself, and we shall learn this shortly. For the moment, let it be remembered that forces of attraction unopposed would tend to draw all the particles of the universe into a single compact clump. If the volume of each particle were infinitely small, so also would be that of the ultimate clump; if the volume of each particle were irreducible below a certain minimum—but we shall ere long find what *that* idea can involve us in! Briefly, there must be something to oppose the attractive forces. To call this something by the name of "force," or even to call it by any single name, would be to limit it unduly. So to the second general statement I give the form:

There must be attractive forces, but there must also be antagonists to them.

If some one wanted a particular problem of the theory of physics identified to him as the profoundest, the problem of these antagonists might well be selected as such.

There is indeed one famed and spectacular case, which makes one antagonist clear. It is the case of the heavenly bodies: the planets revolving around the sun, the satellites around the planets. Why does not the moon fall onto the earth and the earth fall into the sun? Newton's laws of motion tell the answer. The antagonist is *motion*—or, to speak more precisely, momentum—or, to speak yet more precisely, angular momentum. If two particles attract one another but are moving with a relative motion which is not along the line that joins them, they never will meet. However great the attraction between them, it can not draw them together. Attraction can do no more than constrain them to swing in permanent orbits around their common center of mass. Therefore,

The celestial bodies exhibit to us a system kept stable by the attraction of gravity, with motion for the antagonist thereto.

However natural this statement may now seem, it is by no means an idea in-born in the human mind. There was an era when it was believed that motion dies out of itself, unless continually sustained by a never-ceasing stimulus. Were motion to die out of itself, it could not be an eternal antagonist to gravity. Newton cleared the way for the new idea by abolishing the old one.

May we now assume that the ultimate particles of the world act on each other by gravity alone, with motion as the sole antagonist to keep the universe from gathering into a single clump?

The answer to this question is a forthright and irrevocable *no*.

That the answer should be *no* is not at all surprising to this generation, which is familiar with other forces than gravity,

the electromagnetic forces especially. Those who underrate the prowess of our forerunners may feel surprise on hearing that the negative answer was quite as apparent to Newton. No apology is ever needed for quoting verbatim what Newton wrote in English, though it is a dangerous act for the quoter, whose writing must suffer by contrast with the simple elegance of the seventeenth century. Incurring the danger, I cite from the "Opticks" (a book of which the name falls decidedly short of the scope):

The attractions of gravity, magnetism and electricity reach to very sensible distances, and so have been observed by vulgar eyes, and there may be others which reach to so small distances as hitherto escape observation. . . . The parts of all homogeneous hard bodies which fully touch one another stick together very strongly. And for explaining how this may be, some have invented hooked atoms, which is begging the question; and others tell us that bodies are glued together by rest, that is, by an occult quality, or rather by nothing; and others, that they stick together by conspiring motions, that is, by relative rest among themselves.² I had rather infer from their cohesion, that their particles attract one another by some force, which in immediate contact is exceedingly strong, at small distances performs chemical operations, and reaches not far from the particles with any sensible effect.

Further along in the "Opticks" we read:

Thus Nature will be very conformable to herself and very simple, performing all the great motions of the heavenly bodies by the attraction of gravity which intercedes those bodies, and almost all the small ones of their particles by some other attractive and repelling powers which intercede the particles.

With the powerful aid of Newton we have now distinguished between the attractive force of gravity and another attractive force, for which I retain the old-fashioned name "cohesion." I give another basis of distinction, one which could not have been found until in the mid-nineteenth century the equivalence of heat with mechanical work was estab-

² These remarks seem to be aimed at Lucretius, or else at the Greeks from whom Lucretius took some of his ideas.

lished. Consider a piece of solid or liquid matter, and put the question: how much work must be done to tear its atoms apart and dissipate them into the infinite reaches of space, if the only force whereby they act on one another is the attraction of gravity? The question is answerable, if it is known how massive the atoms are and how far apart (on the average) they are. These things are known. The result of the computation is to be compared with the amount of work which is actually expended—in the form of heat—when the solid or liquid is volatilized into vapor. It is found that only about the billionth part of a millionth part of the heat so spent is devoted to "breaking down the gravitational bond," to doing work against the attraction of gravity which is overcome when the atoms are dispersed.³ All the rest is required for overcoming that more intimate force of cohesion.

Gravity now is pushed into the background, and sinks into the relative insignificance which may be gauged from the fact that in the endless speculations of physicists and chemists as to how matter is built up and joined together, it is completely left out. The force which dominates the planets, which makes a hill so hard to climb and a height so dangerous to fall from—how amazing that it should be trivial, compared with others which the flame of the gas-jet vanquishes as the water boils out of the kettle! Trivial of course by comparison only, and at small distances, not at great; or to phrase the situation better, it is the force of cohesion

³ The computation for mercury was made by my colleague, Dr. L. A. MacColl, on the basis most favorable to gravity: by assuming mercury to be a continuum, or in other words, to be made up of infinitesimal atoms infinitely close together—an assumption giving the greatest possible value to the work required for spreading the mercury through infinite space, if gravity be the only restraint. The latent heat of vaporization of mercury is found by experiment to be $1.88 \cdot 10^{10}$ times this value. Thus the contrast mentioned in the text is not contingent upon knowledge of the mass and spacing of the atoms, though the knowledge is available if wanted.

which is trivial at great distances, gigantic at small. This is the contrast which is implied by the technical terms of physics, "long-range forces" versus "short-range forces." Gravity is long-range, because it falls away gently with increase of distance; cohesion is short-range, because it falls away precipitately. We shall soon be meeting with other examples of either character.

One other fact to illustrate the short-range quality of the cohesive forces: When a kettle of water is boiling away on the stove, the amount of heat consumed in dispersing the first cubic inch that departs is the same as is spent in dispersing the second, and the third, and each of the others down to and including the last. This could not be so, if the particles were drawn together by important long-range forces; for then each cubic inch would be easier to drive off than that which last preceded it into the vaporous state, since there would be less of the liquid remaining behind to attract it.

The celestial bodies—useful as they have been in showing us the laws of motion—have therefore served us badly by hinting that gravity is the sole attractive force, a hint which is quite misleading. In another important respect they fail to give us a lead: they show us no examples of collision. Collision, more commonly known as impact, is one of the most important of earthly phenomena, as it is one of the most uncomfortable. The apple which fell in the orchard of Newton, and inspired him with the law of gravitation, may have been a legendary apple; if it was real, we may be sure that it ended its fall in a collision—ended its fall, not its existence. It did not pass through the globe and pop out of the ground in the Antipodes; it did not instantly merge with the grass or the soil of the orchard; it bounced and rolled a little, perhaps, and then lay quietly pressing against the earth, entire and whole. The earth was impenetrable to the apple, as the apple to the earth.

We do not even have to look to impact, to be taught this lesson about the impenetrable. Not less impressive than the fact that the piece of iron sticks together, is the fact that it does not shrink. For any particular choice of temperature and pressure, it has a particular volume which is its own. Work or heat must be expended to dilate it or tear it apart altogether, but also work must be expended to make it denser.

Having ascribed to attractive forces the fact that it takes heat—or let me say henceforward, energy—to vaporize a piece of matter solid or liquid, we now ascribe to repulsive forces the fact that it takes energy to squeeze the piece. The forces must be short-range—still more short-range than are the cohesive forces, inasmuch as these come into play to capture the atoms and hold them together, before those get their opportunity of crying "hold, enough!" They must be very potent, for the most terrific pressures which have been achieved by man do not avail to squeeze the most compressible solid into one-third of its original volume. Why talk of artificial pressures? Everywhere in the globe of the earth, except within a hundred miles of the surface, the pressure is greater by far than any of them; and yet, the average density of the earth is less than double that of its superficial crust.

We have imagined that as two atoms approach each other, the gravitational force between them rises gently, the cohesive force remaining undetectable till they come very close together, when at some critical distance it begins a sharp and sudden rise which quickly carries its value far over that of gravity. Now we are to conceive of yet a third force, repulsive, undetectable till they come still closer together, then at a lesser critical distance entering on a sharper more sudden rise which rapidly carries its value far over those of both of the other two.

This essential and powerful force has no name of its own. This is because it is

usually described in words not conveying directly the notion of force. What we have now encountered is the concept of the incompressible atom, the particle of irreducible volume—the doctrine that the atoms are to be pictured not as infinitely small like the points of geometry, but as hard impenetrable elastic pellets, minute indeed but not inconceivably so. This is a doctrine frankly expressed by many a thinker of the past, who perhaps was more unwilling than we to receive uncritically that difficult dogma of the point of infinite smallness. Hearken again to Newton: "It seems probable to me that God in the beginning formed matter in solid, hard, massy, impenetrable, moveable particles . . . incomparably harder than any porous bodies compounded of them; even so very hard, as never to wear or break in pieces; no ordinary power being able to divide what God himself made one in the first creation."

The completely unsqueezable atom corresponds to a force of repulsion which passes suddenly from zero to an infinite strength at a certain critical distance. The critical distance is the "radius of the atom." Reversely the idea of a force of repulsion rising rapidly indeed, but always continuously, as two particles draw nearer—this corresponds to a squeezable atom, without a definite radius. Solids and liquids in bulk are compressible, and this seems to rule out the former idea, which anyhow is more drastic than one likes to accept. It is not ruled entirely out, for there may be interstices among the particles, and the shrinkage entailed by pressure may be ascribed to the atoms so setting themselves that the cavities lessen in size. However, this does not seem adequate, and it is better to accept a compressible atom and make it share with the cavities the responsibility for the shrinkage. Then there is also the fact that solids expand when warmed. This is ascribed to the atoms dancing around with the heat, and so we approach a new situation

in which repulsion and motion are allied as the two antagonists to cohesion.

Instead of exploring this situation further, let us ask whether there is a difference between the concept of the more-or-less squeezable atom and that of the force-field curiously devised which I have been describing. Formally, there is not. But in respect of the path which the mind next tries to follow, there is a difference, and a great one.

The compressible atom being accepted, one asks, of what is it made? and finds that one is thinking of a continuous substance, elastic and dense. One who is trying to become a thoroughgoing atomist is hardly pleased to discover a continuum at the base of the theory. The displeasure would not be long-lasting, if by assigning a few simple qualities to the continuum one could arrive at the right numerical values for things that can be measured—if one could infer, for instance, that the continuum by its nature divides itself into globules of just the same radii as the structure of crystals demands for the atoms. We are to meet in nuclear physics with a calculation singularly like this—but in general, the feat has not been done. It is not an adequate retort to say that the thoroughgoing atomist is obliged to assign to his atoms the sizes and the masses which they actually have, without giving any deeper reason. He manages to avoid the question; it becomes imperious, when the continuum is brought upon the scene. The road to success may lie by way of the continuum, but it is a road that has not been successfully trodden.

The force-field around the point-particle being accepted, one asks, why this so curious force-field? An inverse-square field would seem so natural as not even to ask for further explanation (but this is probably because the human mind has had two and a half centuries for getting accustomed to it). This combination of a short-range attraction with a repulsion still shorter in range cries out for explanation. Could one but somehow re-

duce it all to inverse-square forces, one would be more contented. This road seems impassable, but already it has been trodden—built and trodden—to splendid successes. Therefore I lay aside the compressible atom scooped out of a continuum, mentioning that even now we have not heard the last of it. Two stages of preparation are now required.

First, I must take more care henceforward in using the words "atom" and "particle." Hitherto I have used them interchangeably; from this moment on, "atom" is to have one meaning and "particle" another. Of the two, it will be "atom" which comes the closer to meaning what both words have meant up to now. Atom will attract atom by the force of cohesion; atom will repel atom by the nameless short-range force. The atoms in their turn will be made up of more elementary particles, bearing such names as "nucleus" and "electron." As to the forces between them—that is the topic to which we are coming.

Second, I must introduce at long last the forces which the reader has so long been missing from this discourse: the electromagnetic.

Of these, it is the "electrostatic" force which stationary charges exert on one another which concerns us the most. Newton spoke of it in one of the passages which I have just been citing, but the pleasure was denied him of knowing how it resembles gravity. Both follow the law of the inverse-square; yet a hundred years were to elapse between the times when Newton proved this for the one and Coulomb for the other. The electrostatic force is broader though than gravity, for it includes an attraction and a repulsion. There are two categories of charge, the positive and the negative: any charge repels those of its own category, attracts those of the other.

This entry upon the scene of a long-range repulsion modifies the prospects of a successful picture of the world as a congeries of particles, and seems at first

glance to brighten them greatly. Dismiss gravity—forget about cohesion—put the question: in an imaginary universe made up of electrified particles some positive and some negative, acting on one another by electrostatic forces only, is it possible to have stability with all the particles standing still?

Again the answer is no. This is not, however, too disappointing: we are accustomed to motion as the antagonist of gravity in the celestial case; shall we not now introduce it to be an ally to the electrostatic repulsion, the two of them conjointly being the antagonists of the attraction?

Now with real surprise and disappointment, one stands confronted again by the ruthless negative answer. The past revives: I have said that a pre-Newtonian philosopher would scarcely have accepted motion as the deathless antagonist to gravity, because he would have believed that motion dies out of itself. Well, the motion of an electrified particle *does* die out of itself—so says the electromagnetic theory. A proviso must here be inserted for correctness's sake, though it does not alter the situation. Uniform motion does not tend to die out—but uniform motion is useless to our ambitions. The orbital motion of a planet, the swing of a pendulum—on these the theory must be built; but these are accelerated motions; and accelerated motions destroy themselves, when the moving body is electrified. Their energy passes into light, and the body sinks to rest. Aristotle was avenged in the nineteenth century on those who sneered at him; for what he had believed of motion generally, was in effect what they believed of the motion of electricity. Still, as nearly every one knows, there is, after all, an electrical theory of matter; the elementary particles are deemed to be electrified, and the forces between them are deemed to be electromagnetic.

How is all this to be reconciled? By a statement which is the prelude to the

final one—provided, that is, that all works out as well as physicists now hope, and provided also that we avert our eyes from the phenomena called “nuclear.” Having imagined the elementary particles as points possessed of mass and bearing charges, and acting upon one another by electromagnetic forces, we are to treat their motions by the method of quantum mechanics, and not by the method of classic mechanics.

I will not pretend that this is a slight innovation, nor try to represent it as anything less than a great and difficult revolution in some of our most cherished habits of thought. Concepts formerly sharp, even those of position and motion themselves, become hazy; there are pitfalls and labyrinths; the mathematical technique is novel and hard. Yet in the picture of the universe as now presented, there are particles possessed of charge and mass; there are electromagnetic forces between the particles; there is motion of the particles; there is radiation, which it is just barely permissible to disregard in an outline like this one, and which I am disregarding; and outside of the realm of “nuclear” phenomena, there is nothing else. The stability of the world, that is to say, of the picture, is assured by attractions and repulsions electrical in nature, and by motion, with radiation playing an essential part.

The hydrogen atom appears before the eye of the mind as a system of a nucleus and an electron: two particles of known, equal and opposite charges, of known unequal masses, attracting one another by electrostatic force. The force draws them together, but there is kinetic energy and there is motion, and so they stay apart. It takes a definite amount of energy to separate them, and the theory derives its actual value very exactly from a basic principle. Any other atom appears before the mind as a system of a nucleus and two or more electrons. The nucleus bears a positive charge, the elec-

trons are negative; the nucleus attracts the electrons, but they repel one another; there is motion; between the attraction and the motion and the repulsion, there is stability. A molecule is a system of two or more nuclei positively charged and two or more electrons negatively charged, and the same three qualities hold the balance. A tangible piece of metal is an enormous multitude of nuclei and electrons, these latter enjoying a very wide variety of motions, some moving almost as freely as though the metal were a vacuum; again the balance is held, the metal tending neither to shrink nor to explode.

All this is a programme for the explanation of nature; and it is a programme which has been largely fulfilled—wherefore this lecture and a portion of the course. Not everything has been explained, nor ever will be. Quite apart from the phenomena called nuclear, there are countless things and happenings on earth which are so complicated that they may well obey our fundamental laws without ever giving us the chance to prove it. If we should apply our assumptions to them and start to work out the consequences, it would take a geological era to finish the job. Perhaps all phenomena of life are of this type. The most that can be asked for is, that the theory should deal capably with all the phenomena for which it can not reasonably be claimed that they are so complex as to defy any theory. I do not allege that our theory of massive particles, electromagnetic forces and quantum mechanics has done even this. It has, however, done a great deal, so much that it takes a rather skeptical physicist to deny it in the realms to which it lays claim.

In the light of this theory, let us consider the situation of the several forces.

Gravity remains apart and inaccessible, one of the ultimate forces, quite probably a quality of space as Einstein has proposed.

The *electromagnetic forces* remain ultimate, not explained in terms of anything else, united among themselves by the theory of relativity, responsible for the incessant passage of energy to and fro between matter and light which is one of the major features of the world. The ionization of atoms, the generation and the absorption of light, show us these forces at work within the atoms, holding together the electrified particles of which the atoms are made, balanced by motion and by their own dual character of attractions and repulsions.

Cohesion, and the chemical forces which bind atoms into molecules and grade insensibly into cohesion, and the nameless *repulsive* force which holds the balance to them and led many to the concept of the more-or-less-compressible atom: these are derivable from the electromagnetic forces between the elementary particles whereof the atoms are made up. I repeat: *derivable from the electromagnetic forces, with the aid of quantum mechanics*—without which aid they would not have been derived. In the literature one finds incessant reference to “exchange forces”; these are not a novel category, but a step in the derivation.⁴ Here are the fields of research where work is the most active. The theory of chemical forces, which some call “quantum chemistry,” is well advanced; the theory of metals, not so well. Much earlier and much more often than we like, do we impinge on the class of phenomena, for which it can all too reasonably be claimed that they are so complex as to defy the theorist probably for all time. Yet there are many simple ones which have brilliantly been explained, and there is satisfaction on the whole—until one raises the eyes and looks ahead:

⁴ There is also a strange quality of nature bearing in quantum-mechanics the name of “the exclusion-principle of Pauli,” which to some extent resembles a repulsive force acting between similar particles such as electron and electron or proton and proton, under very special conditions.

for the nuclear phenomena are still before us.

As a prelude to these we may view the electron itself. Hardly have we begun to “look narrowly” upon it, before we see the specter rising up of that old antithesis between the point-atom and the atom carved out of a continuum; nor is it long before the specter grows more frightful than it was in the earlier case. If the point-electron is adopted, all the old conceptual troubles return in the company of a new one. The intrinsic energy of this point-particle is infinite—so says the electromagnetic theory; the mass must therefore be infinite—so says the relation of Einstein of which I will presently show the power. If from this alternative we rebound to that of a globule of continuous electrical fluid, the old difficulties come back in the company of another new one. The parts of the globule of negative electricity repel each other, so our electron-model turns out to be a high-explosive bomb. The reader, if he wishes, may seek in Lorentz’ “Theory of Electrons,” a classic of some thirty years ago, the details of a scheme for preventing the electron from exploding by means of non-electrical forces—a surrender, therefore, of the view-point that the ultimate forces are electrical.

Leaving these difficulties still unmastered, I turn to nuclear physics. This is a term which covers two fields: on the one hand, the structure and the qualities of atom-nuclei; on the other, some remarkable attributes of electrons, which they display either when they have tremendous energies, or under conditions which it takes tremendous energies to create. “Tremendous” energies are enjoyed by electrons fresh from radioactive substances, are obtained from the cyclotron and the electrostatic generator, and are found at their extremest in the cosmic rays. Of these attributes the only one which I will mention is mortality.

Mortality: this is a very obnoxious attribute for an elementary particle.

All atomists heretofore have devised their atoms specifically to be immortal, to be *the* immortal things, to be the one thing permanently changeless under the flux of phenomena. But the electron is mortal, subject to birth and to death. Electrons are born in pairs, a positive and a negative springing together into existence. Electrons die in pairs, a positive uniting with a negative and the two of them passing out of existence.

These are not exactly cases of something coming out of nothing and something turning into nothing. Energy, mass and momentum are all conserved. Corpuscles of light disappear where and when an electron-pair is born, are born where and when a pair of electrons vanishes. So far as can be told, the corpuscles of light possess just the energy, just the mass and just the momentum which is destined to go to the nascent electrons or to be left unpossessed by those about to die. Now I have to admit my fault in not elevating earlier the corpuscles of light to a parity with the electrons and the atoms. They have the singular attribute of moving always with the same speed (when in a vacuum); they do not collide with one another, or rather such collisions have not been detected, though collisions with electrons are known; and they suffer from mortality, very much more so than do electrons. (Positive electrons are so rare that negative electrons enjoy an almost perfect security.) Immortality is reserved for energy, mass and momentum. Now we feel ourselves swerving again toward a continuum-theory. The ground is slippery, and I step hastily from it into the last section of this paper, into nuclear physics proper.

All the theory of nuclei is firmly grounded on one basic statement, which is this: the masses of all nuclei are *nearly* integer multiples of a common unit, this being *slightly less than* the mass of the lightest among them.

Here is a statement bitterly disap-

pointing! The little word "nearly" and the three little words "slightly less than" conjointly make a bright hope stillborn. Were it not for those words, we should already have joyously leaped to the conclusion that all nuclei are clusters of a single kind of fundamental particle, different clusters differing only in how many of the particles they comprise. The conclusion is so tempting that one is quite unable to resist it, hoping against hope that the words of frustration can somehow or other be cancelled. Soothing the reader with this veiled assurance, I adopt the conclusion.

The conclusion itself must be tempered at once, for there is a second basic statement coequal with the first: the charges of all nuclei are integer multiples of a common unit of charge. No pernicious adverbs here! This statement is an exact one, to the best of our knowledge and belief. The common unit of charge, as nearly every one knows, is equal to the electron-charge and positive in sign.

The conclusion would still be sound, if the charges of all nuclei were proportionate to their masses (we should merely attribute an equal charge to every particle). Definitely this is not so, being most strikingly denied by the fact of "isobars": there are nuclear-types agreeing in mass, disagreeing in charge. We seek the next simplest assumption, and find that it suffices: Two types of fundamental particles—equal in mass—the one of them charged positively, the other neutral—each nucleus to be distinguished by two integers, one being the number of the charged component particles of the cluster, the other the number of the neutrals—"proton" and "neutron" for the names of the two.

This is the beginning of the program for nuclear theory. Having taken the first step by writing it down, we enter upon the second—and find ourselves on the very road which our ancestors trod when atomic theory was new, facing the same ascents, the same passes and the

same morasses. The long-range forces—the short-range forces—the cohesion—the repulsion—the more-or-less-incompressible particle—the troubles of the concept of the point-particle—the countervailing troubles of the continuum carven into globules—the dream of reducing everything to long-range forces and motion holding each other in balance—every one of these rejoins us on our journey. The mighty difference is, that the road still ends in the darkness, and the dream is still a dream. Therefore it is that the language of nuclear theorists wanders about in the most disconcerting way, so that often in a single article the wording in one place will be intelligible only to a few hundred (if so many) of the most advanced of specialists, and in another will sound like the voice of Newton speaking out of the "Opticks," only in a much more cumbersome manner.

In the atomic world we have already seen how gravitation is neglected, being pushed into the background by the electromagnetic forces and the cohesions and repulsions derivable from these. Now in their turn the electromagnetic forces must recede into the background. This sounds extraordinary. Have we not all been told of the supreme importance of nuclear charges? Have we not been taught that by its charge a nucleus attracts electrons and organizes them into a family about itself and so creates an atom—an atom which coheres with others, so that the world as we know it is organized by the charges of nuclei? All this is true, and very important from our view-point—but not so important, it seems, from the view-point of a nucleus. To this little cluster of protons and neutrons, the mass is more important than the charge; the total number of its component particles is more important than the number of protons separately or the number of neutrons separately; the cohesive forces are more important than the electrical. Perhaps a nucleus cares

little about its charge, and nothing at all about the swarm of electrons which that charge coerces to swirl about it like a cloud of flies, though if it were not for those swirls the world would be barren and dead.

The cohesive forces certainly overpower the electrical. We are in no doubt of this, for the electrical forces are repulsive. Newton had gravity available for binding his atoms together; it was of the right type but inadequate, so he gave it cohesion as an ally. The electrostatic force between proton and proton is a repulsion, so to bind such particles together the Newtons of nuclear physics must overcome it with cohesion as an adversary. How greatly it is overcome is shown in much the same sort of way, as I followed when invoking the vaporization of solids to show how greatly the cohesion of atom with atom surpasses gravity. It is possible (at the end I will mention how) to compare the amount of energy required for tearing apart a cluster of two protons and a neutron with that required for tearing apart a cluster of two neutrons and one proton. The two amounts differ by only a few per cent.; and more surprising yet, the former is the greater! Though the first-named of the clusters contains the inherent explosive power of two protons trying to drive themselves apart by the long-range repulsion, it is stuck tighter together than the other, which contains nothing of the sort. As a minor detail this shows that the cohesive forces depend to some extent on whether the particles are neutrons or protons; but the major conclusion is, that the cohesive forces are the masters.

Are they short-range or long-range? By calling them "cohesive" I have already committed myself, but correctly. There is an argument quite similar to the second which I drew from the vaporization of liquids. Think again of the kettle of water boiling away on the stove. It takes as much energy from the flame

to disperse the last cubic inch of water that goes as it does to drive off the first, despite the fact that the first is exposed to all the long-range forces of attraction exerted on it by all the other cubic inches remaining in the kettle, and the last is not. Therefore the long-range forces which act between atom and atom are trivial, and cohesion is a force exerted by the atoms on their near neighbors only. Think now of the cluster of protons and neutrons which is a nucleus—a massive one by choice, built of two hundred particles or more. Imagine it taken to pieces by detaching one particle after another. I admit that this precise experiment is beyond the art of the physicist, but for a certain reason—the one which I have already promised to give, and will give at the end—he is as confident of its result, as he ever is of the result of any experiment which he has not actually performed. The result is, that it takes *roughly* as much energy to remove a particle when there are two hundred left behind to pull it back, as when there are but a dozen left behind, or any number in between. Therefore the long-range forces which act between the fundamental particles are minor, and the intra-nuclear cohesion is a short-range force.

I have carefully made these last statements rather weaker than their analogues for the water boiling away. The amount of energy required for taking away a particle does depend to some extent on the number left behind, and the long-range forces are therefore minor but not trivial. If the long-range forces are attractive, the binding-energy of a particle—this is the shorter name which is given to the “energy required for taking away a particle”^b—must be greater, the greater the size of the cluster, i.e., the greater the mass of the nucleus. Now

^b It ought strictly to be called the “unbinding-energy” or “binding lack-of-energy,” since it is given as positive when energy must be contributed to the system in order to detach the particle.

for nuclei of some fifty particles or more, the contrary is the case. Therefore the long-range force, or the major one if there are more than one, is a repulsion. We already know of one long-range repulsion, to wit, the electrostatic force between proton and proton. Is this the force in question? The answer is oddly difficult to give with assurance, but at present is believed to be *yes*.

If the answer is definitely *yes*, then the electrostatic force has after all one role of supreme importance in nuclei. It fixes their maximum size and their maximum charge, therefore limits the number of chemical elements, and may indeed be all that prevents the universe from caving together into a single lump of protons and neutrons with the electrons fluttering helplessly around it. So long have the chemists been on the search for new elements, and so completely have they searched, that we may believe them when they say that apart from the works of the “atom-smashers,” no nucleus exists having more than 238 particles altogether, 92 of which are protons. Even the atom-smashers or (as I should rather call them) the transmuters, for all the wonder and power of their art, have not forced the total number of protons upward by more than two or the total number of particles altogether upward by more than one. Moreover, all the two dozen or so most massive nuclei known are subject to explosion—to explosions quite terrific, some of them spontaneous, others touched off by what seems a very minor cause. It may therefore be taken as nearly certain that there is an upper limit to the size of nuclei, and probable that it is electrostatic force that sets the limit.

Now we come down to the short-range repulsion. Such a one there must be, for again we can rehearse the ancient argument. A piece of iron does not shrink into a point; therefore the iron atoms must either exert a force of repulsion or else be more-or-less compressible pellets.

A nucleus does not shrink into a point, but offers an impenetrable front, measurable though small, to an oncoming neutron; therefore the nuclear particles—but why repeat the words?

Shall we interpret neutrons and protons alike as systems of particles still smaller, acting on one another by electromagnetic forces, to be treated by quantum mechanics? Alas, if there is one surety in this field, it is that we can not play quite the same game twice. Quantum mechanics may not be used up (some think that it is) but the electromagnetic forces certainly are. In this direction we have as yet no leadership.

Shall we then adopt the compressible globule or the point-particle with a curious field of force surrounding it? Though the language of nuclear theorists verges sometimes on the former, it is the latter practice which is common—a fact which will hardly surprise the reader. In the specialized literature, one finds many a speculation and (what is of more moment) many an inference about the force-field which is drawn pretty directly from reliable data. As a rule the inferences are expressed in language very different from the phrases of this lecture: “interaction” is used instead of “force-field,” and there are queer and slightly comic technical terms such as “potential-well.” When you read of a “rectangular potential-well,” interpret that what I have been calling the “cohesive force” becomes suddenly enormous at a certain specific radius; when of an “error-well” (1) understand that the cohesive force increases rapidly according to a certain law with decline of distance; when of a “Coulomb interaction” realize that it is the inverse-square force-field of the electrostatic repulsion between proton and proton. Of these interactions I will give only two facts: first, that the short-range attraction is confined within a very few times 10^{-13} cm of the center of the proton or neutron, whereas the cohe-

sive attraction of atom for atom spreads over a radius a hundred thousand times as great; second, that the three short-range attractions of proton for proton, neutron for neutron and neutron for proton are nearly the same.

Shall we adopt the force-fields as given to us by experiment, with some plausible assumptions added (for one can not as yet do without them) and operate on them by the procedures of quantum mechanics, hoping to arrive at (say) values of binding-energies compatible with the data? This is the present, or perhaps I should say the recent, programme of nuclear theory. If one reads the theoretical papers of any one year out of the last ten, one may readily get the impression that success is just around the corner. But if one reads the papers of two or more years and takes note of the rapid changes, the prospect does not look quite so rosy—nor when one overhears the conversations of the theorists themselves. I will not conduct the reader down the paths which are as yet so tortuous and hazy; it will be better to fill in the picture with a few of the many remaining details.

Mass was the first of properties (along with hardness) to be assigned to the elementary particles; the second was charge; to these have lately been added angular momentum and magnetic moment. It is difficult to say when the idea of a spinning atom was first propounded (one recalls the vortices in a continuous fluid which Kelvin introduced as one of the most brilliant of all attempts to contrive a continuum and atoms as a part of it) but easy to fix the time when the idea of the spinning electron became so definite and sharp, as to be successfully used in explaining crucial data; this was 1925. The electron, the proton and the neutron all have equal angular momentum; its amount, common to these three which at present claim most strongly the rank of *elementary* particle, is one of the universal con-

stants. When protons and neutrons are assembled in a nucleus, their axes of spin all point in an identical direction, though not by any means necessarily in the same sense in that direction. It is possible for a nucleus to have zero angular momentum, through half of its particles setting themselves in the one sense and half in the other; the lightest nucleus for which this happens is the alpha-particle, composed of two protons and two neutrons. The magnetic moments of the three elementary particles are very far from equal, that of the electron being some seven hundred times as great as that of the proton, which in turn is half again as great as that of the neutron. One of the tragedies of theoretical physics occurred in this connection. A principle of quantum mechanics had been proposed, superbly capable of serving as a basis for most of the incomplete principles which had already so well justified themselves in atomic physics, and including among its parts the actual values of the angular momentum and magnetic moment of the electron. Its empire would have been extended, had the ratio of the magnetic moments of proton and electron been equal to the reciprocal of the ratio of the masses of these two—actually the former ratio is too great by a factor of 2.78. This contretemps has led many to deny the title of "elementary" particle to the proton; while as for the neutron, the fact that it lacks an apparent electric charge while nevertheless displaying a magnetic moment leaves it also open to suspicion.

Few readers of these pages will be unaware that electrons are observed proceeding out of nuclei: it may well be a source of wonderment that they are denied a residence in these assemblages of protons and neutrons only. This is of course another example of the mortality of the electron. Having observed that it is subject to birth and to death, should we be deterred from supposing that it is

born as it quits the nucleus from which it comes? This rhetorical question gives a false impression of the course of history. There was indeed an era when electrons were believed to inhabit nuclei, when nuclei were regarded as assemblies of protons and electrons only. It ended in 1932; but the observation of the birth and the death of electrons did not ensue for yet another year. What happened in 1932 was the discovery of the free neutron. Only when this particle had been discovered did a physicist (Heisenberg) think it worth while to begin to develop in detail the theory that the components of nuclei are protons and neutrons and no other particles but these.

Now I bring this article to a close by fulfilling my promise to speak of Einstein's relation between energy and mass, which on the one hand has been rigorously tested in the realm of nuclear physics, and on the other has extended that realm.

The relation may be worded in several ways; I will employ the shortest: *energy has mass*.

Now imagine an assemblage of particles sticking together. "Sticking together" is not the dignified phrase of a physicist; such a one would say, more abstractly but more exactly, that energy must be given the particles to take them apart. But energy has mass; therefore the mass of the assemblage must be augmented, when they are taken apart. Therefore the mass of the interconnected assembly is less than the sum of the masses of the particles when free.

Now with a single stroke this principle does away with what otherwise would have been a quite unsurmountable obstacle to the doctrine that all nuclei are made up of protons and neutrons. For "proton" and "neutron" are not merely the names of hypothetical particles whereof nuclei are made up; they are also the names of the two lightest of nuclei. These two lightest of the nuclei

are so massive, that it could not possibly be said that the other nuclei are made up of them, were it not for the detraction of mass which occurs when they are bound up together. This deficit of mass corresponds to the unbinding-energy or, badly called, the binding-energy of which I earlier spoke. The binding-energy is the amount of energy which must be supplied to the nucleus, to break it up into protons and neutrons. The deficit of mass—the difference between the actual mass of the nucleus, and the masses of all its neutrons and protons dispersed into freedom—is related to the binding-energy by Einstein's relation.

I have said that this relation has been tested in the realm of nuclear physics, and has served also to extend that realm. The possibility of testing arises from the fact that in certain cases the physicist is able to convert a system of two nuclei into a system of two other nuclei, the masses of all four being known. This seems a somewhat pedantic way of expressing the well-known fact that in performing an act of transmutation, the physicist causes one nucleus as "projectile" to impinge upon another as "target," whereupon the two merge and two others spring apart from the scene of the merger. The masses of the two initial nuclei do not as a rule add up to the same precise sum as the masses of the two final nuclei. But if to the first pair of masses we add that of the kinetic energy of the projectile, and if the second pair is augmented by that of the kinetic energies of the final nuclei—why, then, the equation balances, and Einstein's relation is justified.

As for the extensions of the realm of nuclear physics, or let me rather say, the realm of physics generally: no fewer than three have been stressed in these few pages. First, mass could not be conserved in the birth or the death of electron-pairs, were not the energy of the electrons accompanied by its mass when

it passes out of or into the form of radiant energy. Then, we should have had no prior hint⁷ that the system of two protons and one neutron requires more energy to unbind it, than the system of two neutrons and one proton; this was deducible from the masses of these two nuclei, before it was attested by the discovery that the latter changes spontaneously into the former. Then, we should not have the evidence that the binding-energy of the individual particle lessens, as the number of particles remaining behind in the nucleus increases; for this is a statement derived from observations on the masses of the nuclei.

So all seems well with the model of the nucleus as a system of protons and neutrons, and the particle-theory stands triumphant. Yet notice at what a price this triumph has been bought! Of all the attributes of the fundamental atom, of the elementary particle, constancy of mass was the earliest and the most firmly accepted. The elementary particle was a bit of immutable mass, set forever apart from change. Now it turns out that when the particle adheres to another, some of its mass departs. What has departed is not perished and gone. It is known sometimes to have passed into radiant energy, sometimes into energy of motion, sometimes into that mingling of the two which is known by the name of heat. Changelessness has ceased to be the quality of the atom, remaining that of the mass and the energy of the world as a whole. Immortality has gone from the atom back into the continuum. This is as good a place as any to step out from the incessant alternation, never yet ended and probably endless, between the particle and the continuum as the basis of thought about physics.

⁷ "Hint" is the strongest word that I should use here, since the masses are so nearly equal that it was not possible to affirm with entire certainty in advance which nucleus was the heavier.

THE HUMAN SIDE OF SNOW

II. SPORT AND TRANSPORT

By Dr. J. E. CHURCH

METEOROLOGIST, NEVADA AGRICULTURAL EXPERIMENT STATION

THE article on the "Human Side of Snow," which appeared in THE SCIENTIFIC MONTHLY, February, 1937, has at editorial suggestion grown into a series showing human adjustment to environments of snow and ice. The first article already published is "The Saga of Mount Rose Observatory."

The rapid progress in man's pleasurable adjustment to snow since the writer's first winter ascent of Mount Rose in 1895 in response to a challenge has made possible his recently uttered truism, "Then I was a 'damnfool'; now *all* are." Defense has become superfluous. Two million people annually seek the snow for pleasure, and mountaintops are scaled on ski. Snow-survey courses in the Western States alone exceed 750, with 14,000 snow-samplings. The original Snow-Survey Conference that was held in the West for snow-surveyors only has grown into three snow conferences covering the breadth of the United States and Canada and devoted to all the fields of interest of snow and ice, including the protection of fish and wildlife.

SNOW REMOVAL

Doubtless the first people to appreciate the advantages of snow and ice were the dwellers of the tundra regions around the Arctic seas, where summer travel inland was slowed by the soft turf and was confined largely to cruising along the shores. The winter increased both the range and the speed of intercommunication. Dogs and sleds were the key to mobility.

In the south where transport reached across and beyond the snow areas, road clearance, or in ship parlance canal

building, was practiced. This was a gigantic effort but permitted continuity of wheel traffic with only slight interruption at intervals through the winter.

Snow removal has now become a highway function in 36 snow belt states. In 1939-1940, 232,615 miles of roads were cleared at a cost of \$20,969,988.

In California last year snow-survey methods were used to determine the character and weight of the snow to be removed with a view to opening up an 11-mile stretch of highway over the crest of the Sierra Nevada to the southern end of Lake Tahoe. It was found that the amount was 163,000 cubic yards of snow, weighing about 34,000 tons, or 417 pounds per cubic yard.

In the State of Washington snow textures as well as snow depth have become a problem because of the variable climatic conditions that prevail.

J. D. MacVicar, maintenance engineer, Department of Highways, has found that west of the Cascade Mountains the snowfalls are quite generally loaded with moisture and the prevailing winds are tempered in severity. East of the Cascades the snow is much lighter and minimum temperatures in winter vary from zero F. to 30° below. Farther east in the state, however, the snow, being drier, drifts with only moderate winds following and even during precipitation.

Along the Columbia River Gorge, where the terrain rises abruptly from the river, various and unusual types of snow are found. In this area "graupele," or tapioca snow, being spherical, does not lie where it falls on the mountain sides but rolls down on the level cross-sections

of highways and railroads or at the foot of the cliffs.

At times, however, a heavy wet snow occurs of such large water content that it will not compact under traffic. Its removal *during* the storm period is very important as a slight lowering of temperature will cause a frozen slush which makes highway travel practically impossible.

Rainstorms when the temperature of the air is near freezing may form ice to a depth of two or more inches on the highways in a few minutes. To correct this condition the surface of the ice is striated and covered with sand. Any abrasive applied before the surface is striated is blown off as fast as spread.

Occasionally snow falls so dry and fine that it will not compact but is blown about like dust in the breeze.

The depth of the snow cover on highways through areas of maximum snowfall has proved to be less formidable than anticipated, for new snow is thoroughly removed after each storm and the snow cover rapidly settles.

In 1932, a year of normal snow depth in the central Sierra Nevada, the depth of the settled snow in the passes on April 1 was as follows: Tioga Pass (9,900 ft.) 6.7 ft.; Sonora Pass (8,800 ft.) 6.2 ft.; Carson Pass (8,600 ft.) 9.0 ft.; Donner Pass (7,017 ft.) 7.5 ft.

In the Cascade Range, at Snoqualmie Pass (3,019 feet) east of Seattle, Washington, the normal depth based on measurements over 15 years is 7.6 feet. However, depths of 15 feet or more are possible.

The removal of deep compacted snow in spring is more difficult, particularly if snow slides have occurred. In Chinook Pass, Washington, where the usual average depth of snow is about 20 feet, a power shovel on crawler treads removes the top course of about 10 feet. A bulldozer is then used to push back the remainder to the level of the road surface

where the loosened snow is picked up by a rotary plow and blown clear of the sides. All snow plows are placed at strategic points and have a two-way radio communication with the outside.

Where both rains and freezing temperature occur the average density of the snow may be as high as 64 per cent., or 40.75 pounds per cubic foot. This is 1,100 pounds per cubic yard, or more than twice that of dry-laid snow.

For ice treatment on concrete pavements calcium chloride is mixed with the sand, but for bituminous pavements salt and sand are used.

In the Great Lakes Region, where the snow is relatively shallow and subjected to alternate freezing and thawing, the way of both maintenance men and motorists is hard. In Michigan, when road and weather conditions are bad or uncertain, a twice-daily forecast is issued. Northward, where the cold is steadier, the snow pavement may be superior to that of summer until the season of slush arrives, which fortunately is brief.

Drainage water from snow is a serious problem, particularly where it underseeps the road-bed or covers the road surface with glaze. Provision is now being made for snow storage with a drainage system to carry the water away.

The burden of snow removal is lessened where feasible by snow sheds and fences. When the snow is too deep to be controlled readily, railways are protected against blockage by snow-sheds, which, however, are usually unpleasant because they obstruct both light and view. On the Canadian Pacific Railway snow-sheds are sometimes of concrete and where feasible detours are built around them for summer use.

If the snow can be controlled, snow-fences are preferred even when high and complicated in pattern to meet the varying conditions of wind and slope. In the mountains of Norway the snow-fences are unusually high and in the uplands of



Winston Pote

SPECTATORS ON TUCKERMAN HEADWALL, MT. WASHINGTON,
IN NEW HAMPSHIRE. THIS IS AN UNUSUALLY THRILLING COURSE FOR EXPERT SKIERS WHEN
THERE IS "POWDER" SNOW. NOTE THE SKIER MAKING A FAST TURN NEAR THE TOP OF THIS WALL.

Sweden, where the wind over wide areas is unobstructed by forests, the height of the fences indicates the cumulative effect of wind and drifting snow. Only in the pine and fir forests do snow-fences become low or disappear.

The Japanese scientists have undertaken efficiency experiments by means of models of fences in a wind tunnel. Fine powder is used in place of snow.

They have found that "if there is a secondary fence behind the main fence at

In these days of war emergency a most welcome snow remover for airports has been designed by John B. Sweeny, of the Allegheny County, Pennsylvania, Bureau of Maintenance, that "virtually burns away the snow." As described by *Engineering News-Record* (February 6, 1941):

The novel equipment consists of a 7- by 10-foot wide box equipped with six burners fed by a mixture of crude oil and air from a 300-gallon tank-truck.

On the first test the machine cleared a ten-foot wide path of three-inch snow, operating at a speed of six-miles per hour. A scraper attached to the front end of the steel box heating-chamber removes deep snow and at the rear a wiper blade spreads out the water from the melted snow, thus helping the heated pavement to evaporate the water. It is estimated that an emergency-landing area, 150 feet wide and long enough to permit planes to land and take off, could be cleared with the machine in an hour.

SNOW TRAVEL

Sleds. Specialized snow transport is employed where the snow is continuous, but dual-use vehicles are being developed. Although other qualities are also essential, ability to traverse soft snow is prime. The goal of this development, however, is still distant and elusive.

The Arctic sled, like the kayak for water, has been most efficiently developed for strenuous conditions of snow and ice. So snow-conscious have the natives become that they have invented several terms for snow to designate its traversability, and so expert have they grown in controlling sleds on side slopes and declivities that they are proud masters of the craft.

Dogs are naturally the motive power, and the accompanying man power is sufficient to extricate the sleds when bogged. Where timber is thick, as at lower latitudes, the dogs are attached to a lead line, but on the open tundra and ice the dogs are individually attached to the sled and spread out in a broad fan within close reach of the driver.



THE SNOW PLOW IS DWARFED
BY THE TOWERING WALL OF SNOW.

a distance of about ten times the height of the latter, a calm zone can be gained between them to prevent a cut there from being buried by drifting snow."

Where the drift snow is abnormally copious, the storage capacity of the fences can be increased by erecting additional panels upon them. In Wyoming, snow clearance in both railway and highway cuts has on rare occasion been desperate because of the cement of gravel and snow deposited by winds.



Nevada Photo Service

WINTER SCENE ON ROUTE FORTY IN THE SIERRAS

THE WEATHER STATION OF THE UNITED STATES AIRWAYS, CAN BE SEEN IN THE UPPER RIGHT-HAND CORNER, OVERLOOKING THE SUMMIT OF DONNER PASS.

A loop of rope thrown over the forward end of the runner and dragging beneath it provides a brake. On steeper slopes the sled is allowed to run over the traces, thus reversing the position of dogs and sled, and the slower speed of the dogs serves as a back drag on the sled. The more knowing dogs lie down

and are hauled thus to the bottom. The driver at the handles directs the speeding sled, the beat of his feet sounding like accelerating pistons.

On the inland ice of Greenland necessity forced sudden developments in transportation by the Michigan-Greenland Expedition when returning to base



Nevada Photo Service

LOOKING DOWN THE VALLEY TOWARD DONNER LAKE

THIS WINTER VIEW OF THE DONNER PASS ROUTE SHOWS THE SNOW SHEDS OF THE SOUTHERN PACIFIC RAILWAY ON THE MOUNTAIN TO THE RIGHT.



CUTTING A ROADWAY THROUGH STEVENS PASS
IN WASHINGTON STATE AT THE END OF A WINTER SEASON.

from its winter trip of 1927-28. The downslope winds had cleared the snow from the ice and destroyed traction for feet as well as sled. Descent was therefore effected by easing the sled by means of a cod-line paid out by two men whose joint weight behind a hummock served as a counterpoise. Fortunately the strength of the cod-line also permitted the lowering of the loaded sled down an abrupt ice-face that had been developed across the trail since the inward trip.



OPENING UP CHINOOK PASS IN WASHINGTON STATE

A surplus load of instruments and cameras was more readily hauled in a caribou tarpaulin suggesting an elongated seal with the fur side out to create friction on the ice.

Iceland ponies were used by Koch and Wegener in 1913 on their journey across widest Greenland where the snow was more stable, for ponies could also carry packs from the bare coast to the snow-fields where sledging would begin. However, the sole surviving pony,

courses. The snow is relatively shallow and offers little obstruction, but the river ice sometimes breaks under the weight. Airplanes flying the route keep sharp outlook and are readily summoned.

Of the same general character is the "Sno-Motor" developed by the U. S. Forest Service at Mount Hood and used by the Southern California Edison Company in the High Sierra. It consists of a broad single-tread caterpillar, steered by cables attached to a trailer snow-pon-



WINTER SCENES IN THE CENTRAL SIERRA NEVADA

Left: CLIMBING IN A WIDE-RUNNER SLEIGH ON THE ROAD FROM CARSON CITY, NEVADA, TO LAKE TAHOE. THE HORSES TRAVEL TANDEM AND SOMETIMES WEAR SNOWSHOES. *Right:* AN OLD PUSH-
FLOW THAT WAS USED IN EARLY DAYS ON THE NARROW GAUGE RAILWAY TO TAHOE.

Grani, at the end of the traverse was unable to thread the crevasses where the ice descended sharply to the shore. The pet dog who kept pace with his master became a last meal before a chance boat from Pröven chugged past. Reindeer are doubtless economically superior to dogs where caribou moss abounds, as in Lapland and the barrens of British America and Alaska.

Near the end of the evolution of snow transport is the sled train drawn by a caterpillar tractor. Such trains bear heavy freight to the camps and mines of lower Canada, but are confined to definite routes along roads and frozen water

toon. It can therefore traverse deep and relatively soft snow. From Huntington Lake to Florence Lake it carried 12 passengers and approximately a ton of freight up maximum grades of 55 per cent. and along side-hill slopes of 25 per cent. Snow depths varied from 3 to 12 feet. Its speed for the 30 miles including stops was 3 miles per hour. Its fuel consumption was $1\frac{1}{2}$ gallons per mile.

Of lesser power but greater adaptability are several motor sleds that offer runabout service for mail, snow-surveying and sport. They constitute an emergency means of rescue in the National Forests, where they can be readily

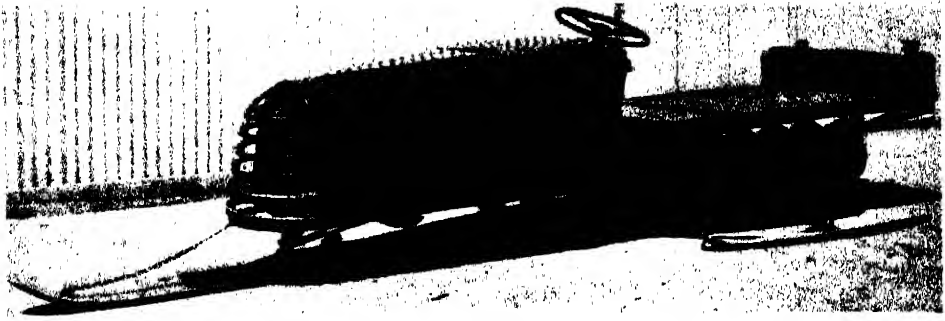

E. M. Tucker

TUCKER SPIRAL-DRIVE SNOW SLED

THE DRIVING DRUM CAN BE DEPRESSED IN SOFT SNOW TO OBTAIN GREATER TRACTION.

transported by auto trailer to points of departure. Their motive power varies from the dual-use caterpillar through the spiral cylinder and "escalator" toboggan, to the air-propellor sled. The first seeks mobility where bare ground alternates with snow. The second is the well-known screw propulsion applied to snow. The third represents the combined use of the endless belt drive and the broad toboggan, the fourth seeks the air drive uncontrolled by the character of the snow.

All have their advantages and are being further refined particularly to meet the impediment of soft snow. The caterpillar sled, known as the Sno-Cat, under recent tests approaches the ideal requirements of buoyancy and traction where propulsion must be provided by

the snow itself. Snow friction is eliminated except on the steering ski and the body is set high to permit the two driving belts to compress the snow to stability. Still greater height of bed is desirable where the snow is unusually deep and unconsolidated. This sled under favorable conditions is capable of attaining a speed of fully 20 miles an hour. The spiral cylinder of the second sled is acquiring a smaller drum with correspondingly wider spiral fin and broader ski. On the other hand, the toboggan sled is having its side runners decreased in width and the tractor belt correspondingly increased to obtain a more effective grip on the snow.

The "Sno-Plane" strangely was developed in the wild country of southwestern Colorado and has been success-



Four Wheel Drive Auto Co.

ELIASON MOTOR TOBOGGAN

IN WHICH SPEEDS UP TO FORTY MILES PER HOUR OVER UNCHARTED COUNTRY ARE POSSIBLE.

fully used by the U. S. Reclamation Service in the Jackson Lake region adjoining Yellowstone National Park. The small shelter cabin rides low on three duralumin skis, 1 foot wide and 7 feet long, the one in front functioning also for steering. To avoid injury to the propeller open trails must be used. On smooth packed snow, as on Jackson Lake, a high speed is possible. On sticky snow

Snowshoes. The type of snowshoe developed in various countries depends upon the density of the snow and the forest covering. In Canada, where powder snow and thickets abound, the webshoe of large area has long been popular. Where short turns are desirable the bear-paw shape is used despite its tendency to tip. In Norway the ski, or wooden snow skate, has reached high



Nevada Photo Service

ON SKI AT SUGAR BOWL SKI LODGE IN THE HIGH SIERRAS
THE SKIERS PRESENT A SHARP CONTRAST AGAINST THE BACKGROUND OF SNOW.

little resistance is noted because of the constant thrust of the propeller. The 150-mile snow-survey route that once required ten days for skiers can now be accomplished in two and can be made between storms rather than through them.

The individual net weight of these motor sleds does not exceed 500 pounds, thus permitting them to be manhandled when bogged down. Each one can carry two or more persons easily and draw a train of sleds.

perfection because of the firmer snow and open country which afford opportunity for maneuvering and for high speed on down-slopes. Soft snow on hard unbreakable crust is the optimum surface for them. Specialized ski waxes now take the place of the former shellac and a deerskin undersurface serves as an aid in climbing. At Lake Tahoe a top speed on webs of 4 miles an hour could be attained if the snow was firm, but once after a snowfall of $3\frac{1}{2}$ feet 14

miles were accomplished only in 13 hours, a part of which was over a beaten trail. With ski at Jackson Lake, Bennett B. Hill, reservoir superintendent and snow-surveyor, has covered 19 miles in 19 hours but has also made 35 miles in 5 hours. These are cruising, not racing, speeds. The exhilaration of sitting on a pair of ski while landscape and home rapidly draw near is full compensation for a long day's climb.

In the Alps the Bavarian snowshoe, consisting of a small oval hoop with rope mesh, has been developed for mountain climbing where the crust is too steep for broad webs or ski and too thin for shoes and crampons. Both the rope and the edge of the hoop cut sufficiently deep into the crust to give firm footing even where only the side of the shoe has contact. On rocks where snowshoes are discarded for crampons, the former become a negligible weight and package on the back of the knapsack. In descending

steep slopes the snowshoes prevent the impact of the foot from breaking through the crust with resulting injury or even fracture of the leg.

This type was used in the writer's early winter ascents of Mount Rose and Mount Whitney, but fell into disrepute in the softer snows of lower altitudes, the shoes being dubbed "postage stamps" and their tracks "postholes."

Because of their speed and sport value ski have become the dominant snowshoe, although their use is exacting a high toll of accidents and will continue to do so until skiers by their own public opinion insist upon skiing under complete control. A code of ski-ethics and ski-safety has been proposed in Crater Lake National Park by Ranger J. Carlisle Crouch (A. G. U. Trans. Part III, 1940) and the California Ski Association has established uniform Ski-Mountaineering Tests. The National Ski Patrolmen or Life-Guards of the Snow have



R. A. Work
SANTA CLAUS CHIMNEY
 ON A SHELTER HUT WHICH IS OTHERWISE COMPLETELY BLANKETED WITH SNOW.



R. A. Work
THE SAME SHELTER HUT
 IN THE CASCADE MOUNTAINS IN THE SUMMER, WHEN THE WHOLE HUT IS VISIBLE.

organized the N. S. P. S. (National Ski Patrol System) to safeguard winter mountaineers.

The chief cause of present accidents is the tight lashings that hold the ski so firmly to the foot that the ski has the effect of a giant wrench twisting the leg when a "spill" occurs. Lashings which will release the foot when the skier is thrown off balance have been designed and are on the market. They require greater publicity and willingness to try them. Serious accidents have happened even to forest rangers the past winter, which would have resulted in helplessness and fatal exposure had not companions been present. In one case the skier was unable to extricate himself from his ski. The other after continuing three miles on his injured leg was long marooned in a cabin until the snow became compact enough for sledging.

Snow Shelters. On the snowfields, snowshoes or sleds are as essential to the

traveler as a boat on water, for without buoyancy or progress in either element one would quickly perish. Unless the trip is short, sleeping bag, tent or more permanent shelter becomes a haven.

The two absolutes in outdoor life are dryness and warmth. Freezing must be avoided. In the polar regions, snow in the furs or a "sweater" among the members of the expedition is a peril. One must not sleep in a wet bed or in sweaty clothing. The Eskimos keep their fur clothing well ventilated on a trek and strip before entering their sleeping bags.

But warmth is a relative term. Life grows sluggish and slow only at low temperatures, such as 30° to 40° below zero Fahrenheit, while it is comfortable somewhat below freezing. Above freezing the snow becomes wet and indoor heat of the normal type becomes sickening.

Shelters may be of any type. On Mount Rose the original shelter camp at



SLEEPING-BAG TREE AND SAND-BAG SHELTER CABINS
AT AN ALTITUDE OF 9,000 FEET ON MOUNT ROSE.



CAMP ON THE GREENLAND INLAND ICE



THE TOWN OF HOLSTENSBORG, GREENLAND, IN WINTER

9,000 feet consisted of two rabbit-skin sleeping bags left hanging from the limb of a giant spreading tree and lowered to the snow for use. If the warmth of the bags was insufficient, a covering of snow was shoveled upon them. To escape a gale of 70 miles per hour, which at zero temperature Fahrenheit withers the flesh, a "grave" was once dug in the snow for the bags. The next season a sandbag hut 3-men wide and half-a-man tall was provided with a large rabbit-skin blanket and a tiny oil cooker. The dog was perforce the pillow. Before sleeping, the oil cooker was extinguished, for it might be kicked over and the exit was small. Here storms of thirty-six hours were outstayed in comfort. A full-height sand-bag cabin was provided to permit one to stand erect.

Frequently it is possible to locate cabins where the ground is blown bare of snow, but sometimes the snow lies uniform and may reach depths far above the cabin roof. Digging either in or out is a severe exertion, providing the cabin can be found. Entrances therefore are provided in the peak of the cabins or a "Santa Claus" chimney is extended upwards—in the Cascade Mountains to heights of 20 to 30 feet—with a ladder inside for descent. The weight of the snow above the roof of the buried cabins has been measured by snow sampler at 12.5 tons. The area of the cabins was only 10 by 17 feet approximately. The supporting power of the purlins and shakes seems remarkable until the observer finally realizes that the snow by its own cohesion is supporting itself with only moderate weight on the roof.

One can even spend the night in the open in comfort without bedding if a fire can be built. In February during a trip along the crest of the range from Mount Rose Observatory to Lake Tahoe, the bed on the snow proved to be too narrow for three, leaving the writer to



PACK SLED UNDER DOUBLE CONTROL.
ON THE MOUNTAIN-CREST TRIP FROM MOUNT ROSE.

sit by the fire, which was slowly melting itself into the depths of the snow. He soon followed the fire into the pit by making a gridiron of three limbs from nearby scrub and stretched out cozily, dropping an occasional piece of wood upon the fire as it sank deeper beneath him. Toward morning one of the members in the bed eagerly exchanged the bed for the fire and called the chimney bunk good.

Tents of any kind will suffice if light and adaptable. On the winter ascent of Mount Whitney, a "cowboy tent" resembling a torpedo was used to enclose the sleeping bags at night and was stretched out as a tarpaulin shelter against falling snow by day. At Lake Tahoe a "silk tent" with water-tight floor was hung from the branch of a tree. Later a cabin cruiser was developed for transport and shelter.

On the Greenland inland ice in winter a waterproof tent with snow floor was



A WHARF OF ICE AND SNOW IN GREENLAND

used. The tails of the tent were skillfully buried in snow and when reinforced by the sled and a rampart of snow blocks resisted a gale of 150 miles per hour that left the ice stripped of snow. Unfortunately, the impervious tent confined the vapor which became hoar frost on the walls and fell upon the furs at every vibration by the wind. A snow igloo would have absorbed the moisture, but the snow was too shallow to provide a dugout or even blocks for walls. The ice was impenetrable with the tools at hand and the task of excavation would have been exhausting. Where the snow is shallow the Eskimos use a pervious muslin tent for shelter and a similar case for their caribou sleeping bags to permit the outward passage of all moisture.

The importance of dissipating moisture was driven home to the writer when he insisted upon inserting an arctic-hare sleeping bag into his caribou bag for greater warmth. For three nights he was as warm as the proverbial bug but spent the fourth night massaging his stinging feet. Every toe turned blue and ultimately lost but regained its nail. Body moisture had formed frost in the fur and the lamps were too weak to dry either boots or bed. The inner, lighter bag was therefore discarded for independent use the next spring when the ice was melting on the inland lakes and the geese were nesting on the shore. Heavy socks, however, became a consolation throughout the winter nights. Dog-skin inner boots required no socks during the day.

The peril of freezing perspiration was even more obvious in two earlier incidents. One evening in the early winter cold legs and feet drove the writer at top speed up the trail to the observatory for warmth, where he found his rubber packs lined with ice. They were promptly discarded for native boots. The rubber even when dry became hard

in the cold and the rubber bulb of the camera sounded like ivory. Later for our winter trip to the inland ice, Marius Kleist, our native companion, prepared a wind-breaker suit from the remnants of a waterproof tent. On the very first day after a strenuous climb with dog-team up the ice front he returned with his clothing lined with ice. His tattered denim suit was immediately substituted for the other with complete comfort during the remaining weeks of the trip.

Nature sometimes exacts a higher price but usually is kind. Thus, early in winter mountaineering it seemed prudent to test the warmth of a rabbit-skin sleeping bag before venturing on a winter trip up Mount Whitney, being taken solely to shock the Californians into the realization that snow outings could do them no harm. The writer therefore spent a night in his bag on the open snow with a sheet thrown over his sled as a breathing tent and his feet encased in felt boots. The temperature was approximately 20° F. below zero. Ice needles from his breath fell from the tent onto his face and his feet became sticks but regained pliability next morning with walking. From the experience came immediately a kangaroo feather-pillow for the bottom of the bag into which to insert the two feet for mutual warmth in place of individual felts that would probably be damp from the day's use.

When caught once by the Arctic night in a tent without fire or sleeping bag he rolled up in a caribou skin so small that head and feet projected but forced himself to wake at intervals to be sure his feet were not freezing. He was fortunate to have reached even this camp, for the next tent equipped with fur beds was found partially submerged and frozen by the "weeping" from the ice front. The bed looked cozy from above but was as inaccessible as a fish in a cake of ice.

Precautions must ever be taken. Escapes have too often been narrow and victims now come from the air as well as the snow. A forced descent from an airplane upon the snowfields this past winter has now caused a movement to place the name of the mountain huts upon the door with direction to nearest habitation. Blazes can readily be made from discarded auto-license plates. In ski and snow survey areas, a toboggan with web snowshoes should be cached in each hut with two-way radio where feasible. Ski have proved entirely inadequate for hauling a toboggan in soft snow with a person upon it. When once bearings have been determined, the direction can be maintained even in storm by sighting from the rear and thus preventing the line of march from curving. Snow goggles must be used when the sun is above the horizon, for the reflecting power of clean fresh snow is intense. The reflected heat of the sun from it may be as high as 87 per cent.

A quarter century or more ago the writer suggested a chain of ski huts a day's journey apart up the western slope of the Sierra Nevada to the crests and a winter trip by sled, cruiser and ski along the snow-clad shores of Lake Tahoe and Fallen Leaf Lake to the summit of Mount Tallac, after the manner of the Dartmouth ski huts in the White Mountains and the week-end "bunk and boarding" train for skiers from Stockholm to Lapland. Instead snow-bowls with ski-lifts and moderate-price shelters have sprung up everywhere. New Hampshire publishes a "Winter Map" each year. The "Stream Liner" bears Chicago skiers to Sun Valley, Idaho, and the Central Vermont Railway runs a weekly ski-train known as the Ski Meister to Mount Mansfield from New York and Boston. There "the world's longest and highest chair-lift in the world" has been completed. The lift, which has a horizontal length of 6,330 feet and a vertical height

of 2,030 feet, is capable of handling 200 passengers per hour.

Ski forecasts are issued by bulletin, press and radio. These are vital in the East where cross-country runs are limited and the texture and depth of the snow are changeable. Community singing at railway points of departure provide the "sleighbells."

Airplanes. The Arctic and particularly the Antarctic have become the proving ground of snow transport of all kinds. Peary and Amundsen attained the geographical poles with sledges. The Scott Expedition followed. Gould closed the series of long sled journeys. Byrd and Amundsen-Ellsworth flew to the poles without landing, the former visiting both poles and the latter spanning the Arctic.

Earlier Amundsen-Ellsworth had landed on and risen from the Arctic icefloes with an airplane. Later Wilkins made a landing on his flight over the Arctic Ocean from Alaska to Spitzbergen, and Ellsworth made several on his flight over the Antarctic icecap from Palmer Land to Little America on Ross Sea. Shorter flights with landings were made by Gould and Byrd in Antarctica and flights on the snow have now become established despite possible gales. In the Arctic, the Soviet explorers under the leadership of Professor Otto J. Schmidt have flown almost at will to the North Pole and in May, 1937, established a floating polar meteorological station, the members of which were taken off their melting ice-floe the following February in the Greenland Sea. Soviet fliers have even hopped the Arctic hemisphere from Moscow to Southern California.

For the local work of snow surveying in regions difficult of access, Horace P. Boardman, chairman of the Nevada Co-operative Snow Surveys, foresees the early use of the helicopter, which can descend and rise in narrowly restricted areas and await the convenience of its

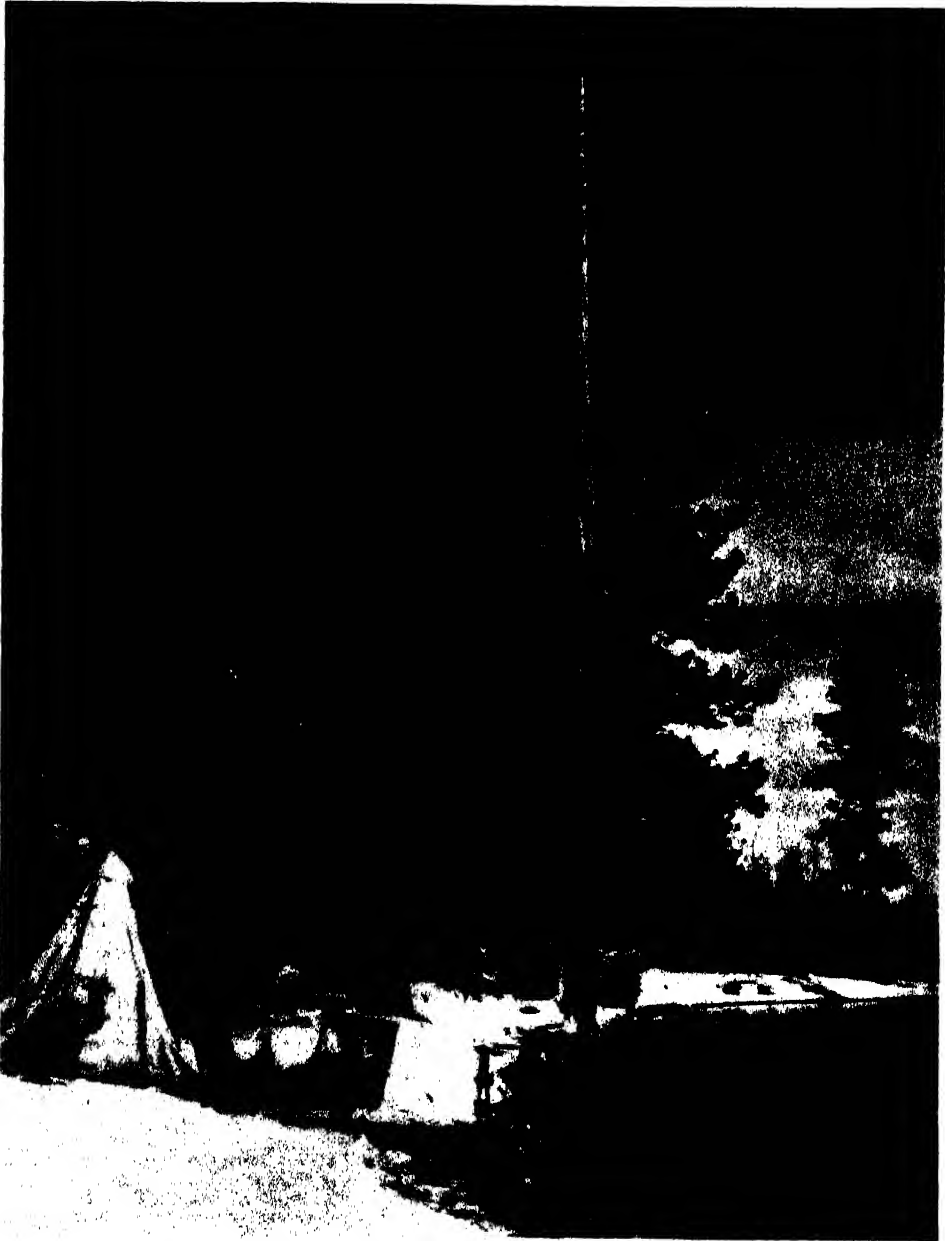

SNOW SURVEY CAMP ON THE SHORE OF LAKE TAHOE
THE LAKE NEVER FREEZES AND THEREFORE AFFORDS READY TRANSPORTATION BY BOAT TO ALL POINTS
ON ITS SHORE LINE OF SEVENTY-TWO MILES.

passengers. The cost may not greatly exceed that of motor sleds.

But a final effort is being made to develop wheel traction on the snow. For the recent United States Expedition to Antarctica Dr. T. C. Poulter developed a snow pontoon with retractable wheels for sliding over crevasses. It was believed that the 10-foot rubber tire wheels would obtain traction before sinking too deep in the snow, but the powder snow of the Antarctic gains density only slowly with depth and cuts deeper beneath the spinning wheels. An endless belt like that of a caterpillar tractor if made sufficiently wide would provide a far greater area of support on the snow without possibility of the snow being cut out. The sand dunes of Lake Michigan, where a favorable test was made, seem to be denser than the Antarctic snow and more resistant to cutting. The tendency of rubber to disintegrate under movement below -60° F. can be avoided by using the cruiser only in summer when higher temperatures usually prevail. The size, cruising radius and auxiliary airplane make the cruiser desirable, but it would become helpless to extricate itself if it ever bogged, and such occasions might be frequent. Dr. Poulter, however, believes that a shift in gear ratio would solve the problem. Meantime, the cruiser awaits a further expedition for its ultimate test.

But initial friction on airplane ski still causes trouble where heavy loads must be raised into the air from a state of rest, and its avoidance has long been a subject of discussion and experiment. Where the temperature of the snow is moderate and the crystals are round, the friction is slight. But when the temperature is low and crystals are angular the friction may approximate that of sand. Likewise, water-soaked snow because of its continuous film of water and surface tension may be adhesive. Koch and Wegener state that in Green-

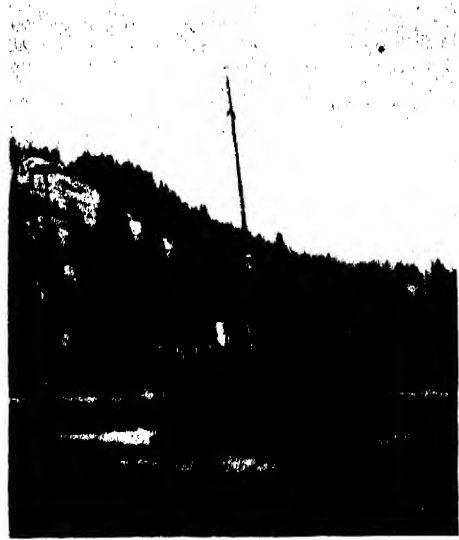

THE CABIN CRUISER MOUNT ROSE.

land at temperatures of about -4° F. ski refuse to run.

In Canada, where airplanes must depend upon ski for landing and take-off, the Canadian Research Council through G. J. Klein has made prolonged tests with valuable results. Observation was had of the contact zone between ski and



MIRROR LAKE BASIN, MOUNT WHITNEY.

snow by a glass window through the body of the ski, while their drag was being instrumentally recorded. His comments are as follows: "The highest sliding resistances measured occurred when the snow was slightly wet and still retained its needle-like structure, but upon losing the latter its sliding resistance was low. Still higher resistances would probably have occurred at very low temperatures."

He suggests therefore that the contact between the ski and the snow takes place at a large number of small areas and that sufficient heat is generated by surface drag to provide water lubrication. The surface drag is then made up of (a) solid friction, (b) viscous drag due to shearing in the thin film of water and (c) drag due to surface tension effects of drops of water which enclose each small area of contact. The proportion of each factor will vary for different conditions. It was estimated from observation that the total area of contact was of the order of 20-50 per cent. of the area of the ski bottom at unit loads of 200-500 pounds per square foot.

The surface tension is therefore large. During sliding this force does not act normal to the ski bottom since the leading angle of contact is greater than the trailing angle.

Decreasing the wetted area, *i.e.*, increasing the unit loading, seems the only method of decreasing sliding resistance in very wet snow.

Five recommendations are made for improving the snow characteristics of ski under all conditions:

A material which resists wear, has a low tendency to wet and which gives low surface tension

drag is required. Of the materials tested, Bakelite fulfils all three requirements most satisfactorily.

High unit loading improves the snow characteristics of skis under all conditions. A unit loading of between 400 and 500 pounds per square foot is recommended instead of 200 pounds per square foot, which is the present general practice.

The ratio of length to breadth should be at least 6. High ratios are particularly important for highly loaded ski and low temperature snow.

Flexible construction assists "unsticking."

The maximum angle of the bow should be between 20° and 25°.

The partial success previously attained in clearing airplane-wings of ice seems now to have been made complete by means of a simple invention by Russell S. Colley. He points out (Bull. Amer. Met. Soc., April, 1941) "that the inflatable shoes, which are attached to the leading edges of air-plane-wings, are effective where they are alternately inflated and deflated. However, it is necessary to have non-extensible strips to hold the edges of the shoes. Since only a small edge, or a sudden change in contour, is enough to cause ice to accumulate, it may form on these strips. The invention provides for an additional inflatable strip to go over the edges of the shoe. The front of the extra strip moves with the large one while the back of it is attached smoothly to the wing, and no ice may form."

A half century of endeavor is bringing its solutions. Snow and ice are no longer insuperable obstacles to man and their once sinister aspect has become a source of appeal. Whether we move over the surface or fly far above the snow-clad peaks, the last and farthest regions of earth are now within our reach.



THE DISCOVERY OF PINACATE VOLCANO

By RONALD L. IVES

BOULDER, COLORADO

HISTORIES of geology usually credit the recognition of extinct volcanoes far from present volcanic regions to Jean Guettard (1715-1786) and Nicholas Desmarest (1725-1815), whose thorough studies of the ancient volcanoes of Auvergne have not only become scientific classics, but form the bases of the modern science of volcanology. A few of the more thorough works justly credit Strabo (63(?) B.C.-21(?) A.D.) with the observation that Vesuvius, inactive at the time of his visit, was a volcano.¹

Recent studies of manuscripts in the archives of Mexico, largely initiated by the work of Herbert E. Bolton, have disclosed three narrative accounts of an exploration of the Sonoran desert region in 1701, during which the Sierra de Santa Clara, now known as the Pinacate Peaks, was correctly recognized as a formerly active volcano.

Since the beginning of the present century, the Pinacate region has been studied by workers in several fields of science, and the findings of this early expedition found quite accurate. Location and immediate geographic environment of the Pinacate Peaks are shown in Fig. 1, an outline map of the Arizona-Sonora boundary region.

The diaries of the three literate members of this expedition, all of which are literally "mines of information," did not come to the attention of English-speaking scholars until about a generation ago, and only one of these has as yet been translated into English.

Pertinent excerpts from these narra-

¹ Archibald Geikie, "The Founders of Geology," New York, 1905. "Strabo," pp. 18-20; "Guettard," pp. 104-139; "Desmarest," pp. 140-175.

tives, which together constitute a fascinating "lost chapter" in the history of North American geology, will be here presented, together with condensed biographical notes, under the names of their respective authors, and will be followed by a brief résumé of subsequent explorations in the same area.

EUSEBIO FRANCISCO KINO, S.J.

Born near Trent, Tyrol, August 10, 1644, Eusebio Francisco Kino, later to become the "Apostle to the Pinnas," received his early education at Ala. After further study, at Ingolstadt and Freiburg, he entered the Jesuit Order in 1665, taught grammar for three years, and became locally famous as a mathematician. In answer to a call for missionaries, Kino came to the New World in 1681, and labored for several years in Lower California. Assigned to Pimería Alta (now northern Sonora and southern Arizona) in 1687, he spent the remaining 24 years of his life Christianizing, exploring and mapping that "so sadly watered vineyard of the Lord."

Chief among Kino's accomplishments are the rediscovery² that California was a part of the American mainland, and not an island³; the production, with crude instruments,⁴ of a satisfactory map of Pimería Alta; and the exploration of a route from Sonoyta (Fig. 1)

² Earlier evidence of the non-insularity of California, found by Melchior Diaz in 1540 and Juan de Oñate in 1604, seems never to have become generally known.

³ H. E. Bolton, "Kino's Historical Memoir of Pimería Alta," Cleveland, 1919.

⁴ Kino's instruments, as determined from his diaries, consisted of a sextant, compass and telescope. The map appears as frontispiece in Bolton, *op. cit.*, I.

to the Gila, now known as the Camino del Diablo (Fig. 2),⁵ and adequately marked by "three graves to the mile." Kino's terse narrative, condensed from Bolton's translation, follows:

On the twentieth (of March, 1701), Palm Sunday, having said the two masses . . . we set out for the west; and after covering six leagues of road, although level, and along weathereed rocks like slag which long ago had been thrown out by this mountain or volcano of Santa Clara, which we passed on our right or to the north, we arrived at another tank of water shut in between rocks,⁶ with very little pasturage; and ascending to a neighboring little hill, we descried California very plainly, to the west and southwest, and afterwards the soldiers also and all the men sighted it.

⁵ Literally, "The Devil's Road." History and topography adequately described by W. J. McGee, "The Old Yuma Trail," *Nat. Geog. Mag.*, Vol. 12, 1901, pp. 103-107, 129-143.

⁶ Bolton, using Lumpholtz's maps and field data, identifies this tank with the modern Tinaja de los Chivos (indicated in Fig. 1 by the letter T southwest of the Pinacate Peaks). Field work in the same area by the writer confirms this identification.

JUAN MARÍA SALVATIERRA, S.J.

Contemporary, close friend and often traveling companion of Kino, Juan María Salvatierra was born in Milan in November of 1644. After studies at Parma, Salvatierra became active as a Jesuit missionary in Mexico in 1675, and was appointed *Visitador* of Pimería in 1690. Instrumental in the founding of the mission at Loreto, Lower California, famous for its bells and pearls, Salvatierra, with the active cooperation of Kino, maintained the ecclesiastical settlement on the arid and poverty-stricken peninsula until his death, from age, illness and over-exertion, in 1717.

Salvatierra's work is not as well known as Kino's, but the available records clearly show that his explorations, a part of his missionary activities as were Kino's, were of considerable scope and importance. Had Salvatierra been a less competent administrator, it is probable that his geographic contribu-

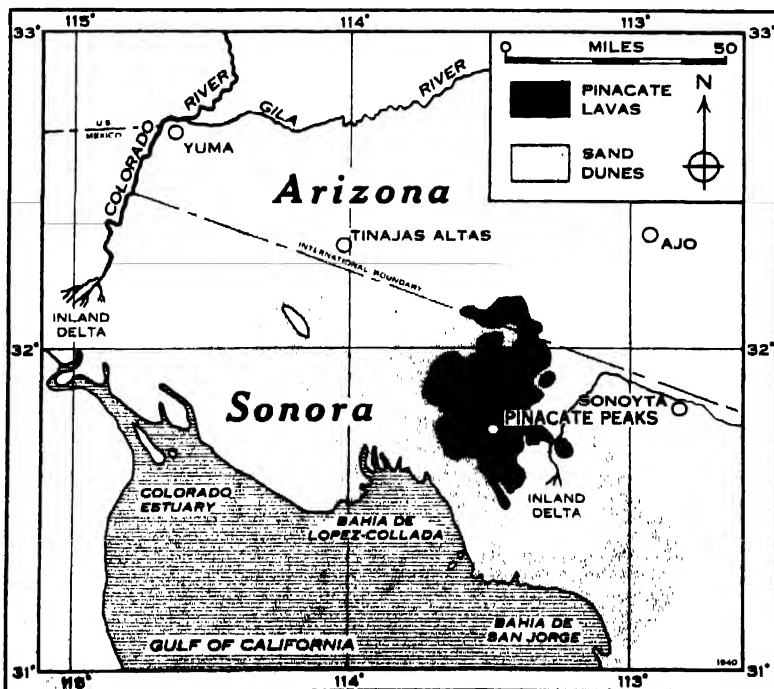

FIG. 1. MAP OF SOUTHWESTERN ARIZONA
GENERALIZED OUTLINE MAP OF SOUTHWESTERN ARIZONA AND NORTHWESTERN SONORA.



FIG. 2. THE CAMINO DEL DIABLO
A SCENE ALONG THE CAMINO DEL DIABLO ABOUT
TEN MILES WEST OF SONOYTA.

tions would have been greater. Salvatierra's interesting narrative, translated from the printed Mexican version,⁷ follows:

... and we left (San José de Ramos⁸) guided by Indians who went after salt, giving us in more detail the trail to the sea.

On climbing a hill a league distant from San José de Ramos, on the flank of the hill of Santa Clara, we found a horrible country, which seemed more like cinders than land, and all of it scattered over with rocks and fragments, all black, and shaped as pitch which has been spilled and run out and become solid. Thus in ancient times a horrible flow of volcanic material left the hill of Santa Clara, which has all the marks of having been a great volcano. It gave us more horror to discover eight leagues

⁷ J. M. Salvatierra, "Letter to Francisco de Arteaga," Documentos para la Historia de Mexico, Ser. IV, Vol. 5, 1856 (9), p. 146. Original manuscript probably written about 1702.

⁸ San José de Ramos is a waterhole in the usually dry bed of the Sonoyta River just south of the present Batamote Hill. For location see map accompanying Carl Lumboltz, "New Trails in Mexico," New York, 1912.

from here a great chain of mountains which seemed also to be made of cinders, so that I do not know where there is a place in which can be better shown the face of the earth in the general conflagration before judgment day. We were much more frightened by the extended range in front of us, for here we will have to cross on the coming day. We travelled six leagues, and were guided to a water hole named by the natives *aybacusi*.

CAPTAIN JUAN MATEO MANJE

Guarding Kino and Salvatierra on several of their journeys into unknown lands was Captain Juan Mateo Manje, commandante of the presidio of Fronteras. His major literary work, "Luz de Tierra Incógnita," still untranslated, contains little direct biographical material, but indicates, by its style and context, that Manje was not only a keen observer, but was educated and well read. In many instances, primitive customs, legends and religious beliefs, usually unnoted by Kino and Salvatierra, are carefully described by Manje.

From information collected by Bolton during his exhaustive study of the Kino manuscripts, it is learned that Manje was a nephew of Domingo Jironza Petrez de Cruzat, governor of New Mexico from 1680 to 1686 and 1689 to 1691. In 1693, Manje was appointed ensign in the newly formed Compañía Volante de Sonora, and rapidly advanced, being referred to as General in 1703. He was still commander of Fronteras in 1720, but apparently died before 1732, when Juan Bautista de Anza, Sr., father of the founder of San Francisco, took charge.

Manje's narrative, translated from the printed Mexican version,⁹ follows:

On the twentieth (of March, 1701) we went toward the sea, with three Indian guides, travelling westward always over rocks and mal país¹⁰

⁹ J. M. Manje, "Luz de Tierra Incógnita," Mexico, D. F., 1926, p. 286. Original manuscript dated 1720.

¹⁰ The term *mal país*, often corrupted, literally meaning *bad country*; used in the southwest to designate lava beds.

and crags and hummocks [Fig. 3]. We went eight leagues, coming to the shoulders of the peak of Santa Clara, where we halted at a place called El Tupo,^{7,11} with scanty pasture and a natural tank of rain water, from which the horses drank, in a dry wash full of rocks and hummocks.

On these two trips¹¹ were seen hills and mountains and canyons of melted rocks, similar to the slags which leave silver when it is refined in a retort. This flux, which the Indians call *temesquitate*,¹² and cinders extend for many leagues from the vicinity of the aforementioned peak.¹³ We believe, and this seems probable, that this was a volcano, which lasted some years, and resulted from the concentration of a great combustible mass of sulfur and niter in an underground cavity. This was greatly

¹¹ The other trip was November 6, 1699. Bolton, *op. cit.*, p. 207.

¹² *Temesquitate* is probably a Spanish rendition of the Nahuatlan *temetztlialte*, derived from *temetztl* = lead (*tetzl* = rock or stone, *metztl* = moon) and *atle* = nothing from or instead of. Nahuatlan mineral names strongly suggest a fairly advanced knowledge of metallurgy. Another example is *tepusete*, Spanish rendering of *tepuatlialte*, primitive name for *gossan* (derivation, *tepuztli* = metal + *atle*).

¹³ See Fig. 1, "Pinacate Lavas."

ravaged, after which, lacking the store of material from which came the beginning of the fire of its formation, the voracity of the combustion ceased, and the materials became fused into this abundance of canyons, hills and mountains, ravaged as we have seen. It is probable that this lasted some centuries, as testify other volcanoes of Europe and those of the two Americas, whose subterranean fires, according to Padre Atanacio Quirquerio,¹⁴ distinguished mathematical philosopher, have lasted four or five centuries, and at times the force and impetus of the materials have become so great that they have broken loose, and great rivers of fire have run out, as those of Vesuvius, and Etna or Mongivelo.¹⁵ In our own times there has flowed from the source a great river of fire, which ran with some speed to the sea, causing it to retire, and depositing, from this copiousness of melted material, a great plain of fragments in the gulf and (on the) sea bottom.¹⁶

¹⁴ One of history's unknowns, no trace of whose writings can be found by the Library of Congress.

¹⁵ *Mongivelo* is a Spanish rendering of the old Italian name for Mt. Etna—*Montgebello*—compounded from the Italian *monte* = hill or mountain, and the Moorish *gebel* = hill or mountain.

¹⁶ This is apparently a reference to the eruption of Vesuvius on December 16, 1631.



FIG. 3. FACE OF A LAVA FLOW
NEAR THE PINACATE LAVA PLAIN, SOMETIMES TO-DAY CALLED "THE SEA OF BROKEN GLASS."



FIG. 4. RIM OF A TYPICAL SMALL CRATER
RISING ABOVE THE EXTENSIVE PINACATE LAVA PLAIN.



FIG. 5. A TYPICAL PLUNGE-POOL WATER HOLE
TINAJA DE CARLINA, NORTHEAST OF PINACATE PEAK.

Thus appear to have come about the hills, mountains and valleys of melted rocks which we have seen. (They were) transformed from this flux which descended from the summit of Santa Clara mountain, where can be seen a depth and profundity which causes terror and fright¹⁷ [Fig. 4].

Here, on another occasion, Padre Eusebio Kino climbed to survey the sea, whose waves seemed to beat at the brow of the hill, but he was deceived, for it is more than nine leagues

belief, as well as the emotional reactions provoked by the chaotic terrain, are outlined by Salvatierra; and the field evidence, accompanied not only by graphic analogies but by an attempt to explain the mechanics of volcanism, is given in some detail by Manje, whose other writings suggest that he was greatly interested in rocks and minerals.



FIG. 6. LAST DEPENDABLE WATERING PLACE IN THE SONOYTA VALLEY AGUA DULCE. THIS SITE, THEN OCCUPIED BY CANEBREAKS, WAS NAMED BY KINO "EL CARRIZAL."

to the sea, where he saw its beaches, dunes, and waves.

VERIFICATIONS

From the context of the three narratives just presented, there can be no doubt that Kino, Salvatierra and Manje believed that the Sierra de Santa Clara, now known as Pinacate Peaks, was of volcanic origin. The reasons for this

¹⁷ Although the source of the recent lavas at Pinacate was quite definitely a secondary crater between the remnants of an ancient crater wall, the largest calderas, view of which might logically cause *terror y espanto*, are north of the mountain mass, in the lava plain.

Kino again visited the Pinacates in November of 1706, accompanied by Fray Manuel de la Oyela y Velarte, Alférez Juan Matheo Ramires and Juan Antonio Duran. Leaving Duran, who was ill, at a water hole near the base of the peaks (Fig. 5), the rest of the party climbed to the summit, and verified Kino's previous observations regarding the peninsularity of California.

Between 1706 and 1882 there is no indisputable record of any visit to the Pinacates, although numerous Papago salt-gathering expeditions undoubtedly

crossed the lavas on their traditional trail, worn into the volcanic glass by uncounted thousands of bare feet. It is possible that Francisco Garces, in October, 1771, stopped at Papago Tanks, on this old trail, during his transit of the desert between the mouth of the Colorado and Sonoyta, but the record is by no means clear. Indefinite legends, and the finding of bones and remnants of clothes by local Indians, indicate that emigrants passed near Papago Tanks



FIG. 7. RECENT ASH BEDS NORTHEAST OF PINACATE, SHOWING CRUDE AEO-LIAN BEDDING. PROBABLY DEPOSITED IN PRE-COLUMBIAN TIMES; ACCORDING TO LEGENDS, THE TRIBAL DEITY BUILT TWO FIRES ON THE PEAKS AND "THE ASHES BLEW-ALL OVER THE EARTH."

some time between 1840 and 1870, perhaps in 1850, during the California gold rush, but further data are lacking.

In 1882, Sr. Y. S. Bonillas, a mining engineer of Nogales, visited the Pinacates, and discovered one of the great calderas for which the region has since become famous.

The first extended exploration of the

Pinacates in modern times was that of the MacDougal-Hornaday party of 1907. This study led to the construction of an accurate map by Godfrey Sykes, to a survey of the botanical and zoological features of the region and to a quite definite verification of the findings of Kino, Salvatierra and Manje. Members of this party also produced the first series of photographs of the craters and lava structures of the area.

Two years later, Carl Lumholtz, ably assisted by Alberto Celaya, spent some time in and near the Pinacate Region, following, unknown to him, almost the same trails that Kino used more than two centuries before. From the notes collected by Lumholtz and Celaya, the Kino itineraries were worked out by Bolton (Fig. 6), and within the last decade, Lumholtz's map has been used in determining the route of the new railroad now under construction between Mexicali, Lower California, and Santa Ana, Sonora. Lumholtz's descriptions at times agree with those of Kino even to the descriptive analogies used.¹⁸

Recent studies in the Pinacates, largely the work of the present writer, have produced no major new discoveries, but show quite plainly that the pioneer work of the expeditions headed by Kino was of a high order of accuracy. Geologic and physiographic studies in the vicinity of the Pinacates indicates that the major volcanic activity there took place during the early Pleistocene, and lasted for many millennia. Since man came to the desert country, not more, and probably much less, than 4,000 years ago, there has been one great eruption of Pinacate Volcano, concerning which

¹⁸ Alberto Celaya, who accompanied and assisted Lumholtz during the major part of his work in Sonora, has since settled in Sonoyta, serving several terms as *Comisario*. The assistance so generously given by him to every scientific worker who has passed through the little Sonoyta oasis has very materially increased the world's knowledge of the Sonoran Desert region.

the Papagos have a strikingly accurate legend¹⁰ (Fig. 7); and one very minor eruption (January, 1935), the surface evidence of which has already (1940) been removed by wind and sheetflood erosion.

CONCLUSION

The narratives of Kino, Salvatierra and Manje show beyond any vestige of a doubt that these early explorers, during the progress of their missionary work, recognized the volcanic origin of the Pinacate Peaks. Whether this iden-

This identification of an extinct volcano in 1701 appears to be one of the first, if not the first, of such reports from North America, so far as can be determined from available literature, and antedates the publication of the works of Guettard and Desmarest, frequently called the pioneers of volcanology, by about half a century.

It seems somewhat ironic that Pinacate (Fig. 8), first recognized extinct volcano in North America, will probably be among the last of such structures to be studied in detail; but in this desert

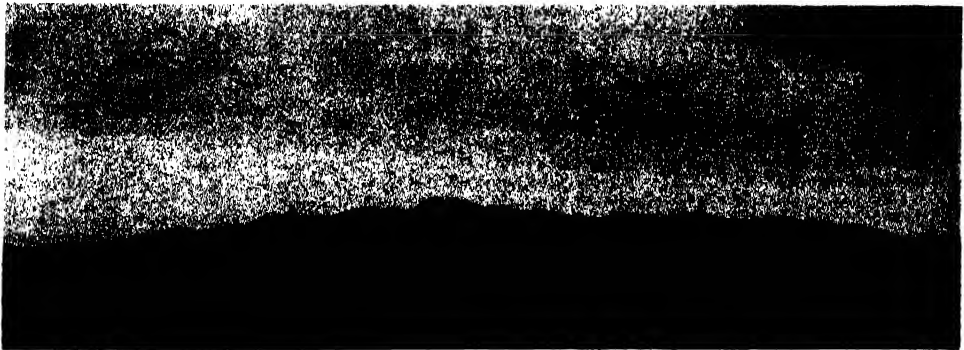

FIG. 8. THE PINACATE MASSIF, SEEN FROM DRY BED OF SONOYTA RIVER NOT FAR FROM KINO'S OLD CAMP AT EL CARRIZAL.

tification was independently arrived at by the three narrators, or was a "group enterprise," can not be definitely ascertained from the accounts.

Subsequent studies by a number of workers, at a much more advanced stage in the development of the science of geology, have shown that the observations contained in these diaries of exploration are not only substantially correct, but are far in advance of their time.

¹⁰ R. L. Ives, "Geologic Verification of a Papago Legend," *Masterkey*, Vol. 9, 1935, p. 160.

region, where even the modern inventions of sheet-iron canteens and steel-armored boots are of little avail against a malevolent and parsimonious nature, many of those who cross the boundaries of the Pinacate country—the waterless, grave-lined Camino del Diablo; the desiccated and caliche-baked bed of the Sonoyta River; and the shifting squeaking sands beside the unvisited red waters of the Gulf of California—heading toward the multicolored peaks rising like islands from "the sea of broken glass," cross them only once, and are heard of no more.

STRUCTURE OF CELLULOSE AS REVEALED BY OPTICAL AND X-RAY METHODS¹

By Dr. W. JAMES LYONS

SOUTHERN REGIONAL RESEARCH LABORATORY, BUREAU OF AGRICULTURAL CHEMISTRY AND ENGINEERING, U. S. DEPARTMENT OF AGRICULTURE, NEW ORLEANS

THE experimental and analytical procedures by which the modern ideas on the structure of cellulose have been established furnish an illuminating example of how various physical methods may contribute to the determination of a structure beyond the scope of direct observation. While optical effects and chemical evidence have been employed in disclosing the crystalline-micellar structure of cellulose, a large step toward a final, dimensionally definite theory was taken with the application of x-ray diffraction data. The study of the structure of cellulose has been pursued with considerable vigor, not only because it is, as Cross and Bevan have remarked, "the structural basis of the vegetable world," but also because it is technologically and economically important. For example, we need merely to note that cotton, cleaned and purified, is about 99 per cent. pure cellulose.

Cellulose is obtained solely from plant materials, but is used in a variety of artificial products made by chemical and physical processing of such materials. In some of the natural plant materials and derived cellulose products there are relatively large regions in which the chain-molecules of cellulose are well oriented, while in others the arrangement of the chains is random. In the native state cellulose is associated with various impurities, and in many of the manufactured cellulose products it occurs chemically modified. This discussion, however, is limited to those properties

and structure which generally characterize cellulosic materials. The cotton fiber has been selected as a typical example of true cellulose for reference purposes, but some of the data which are cited have been obtained on other cellulosic fibers.

I. OPTICAL STUDIES

The first critical observation made with a physical instrument on a cellulosic material probably occurred when some one viewed a plant fiber under a microscope. Such an observation, made on a cotton fiber with a modern microscope, is shown in Fig. 1. The photomicrographic magnification is of the order of 500 to 1,000. The hollow, central lumen of the fiber is obscured. However, the alternately spiraling fibrils, the first subdivision in native cotton cellulose, are clearly evident. The fiber illustrated was swollen to bring out the fibrillar structure, and the angle between adjacent or neighboring laminae of fibrils has been measured. The axis of the fiber is vertical. If such an observation as this were made with a polarizing microscope, *i. e.*, one containing a Nicol polarizer and analyzer, it would be found that the fiber is birefringent (doubly refractive). With a monochromatic light-source it would be found that the intensity of the transmitted light varies, depending on whether the vibration-plane (the electric vector) is parallel or perpendicular to the fiber axis. If, on the other hand, illumination with plane-polarized *white* light were used, it would be found that

¹Lecture presented in part before the annual meeting of the New Orleans Academy of Sciences on March 28, 1941.

the fiber is generally colored, and that this coloring changes as the fiber is turned through 90 degrees on the microscope stage. This is the so-called dichroic effect. Without the necessity of referring to the theory of either of these effects, it is immediately evident that the fiber is optically preferential as concerns direction, *i.e.*, anisotropic. A further conclusion may be reached, namely, that the *cellulosic material* of which the fibrils are composed is anisotropic. The approximate parallelism of the fibrils to the fiber axis, if these fibrils were not composed of an anisotropic substance, could not account for these optical effects, since the fibrils are much too large compared to the wave-length of light.

Nägeli recognized this anisotropy, and about 80 years ago advanced the first theory of crystalline micelles to explain the optical effects.² His theory led him

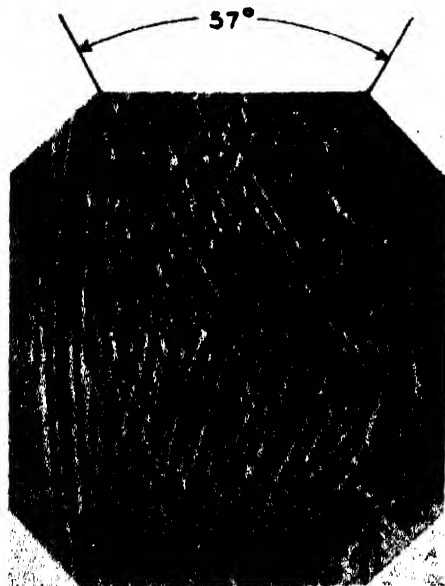

Courtesy of W. A. Hason.

FIG. 1. PHOTOMICROGRAPH OF A COTTON FIBER, SHOWING ORIENTATION OF FIBRILS. FIBER SLIGHTLY SWOLLEN IN PHOSPHORIC ACID.

² Cited by A. Frey Wysaling, *Science Progress*, No. 134, 249, 1939.

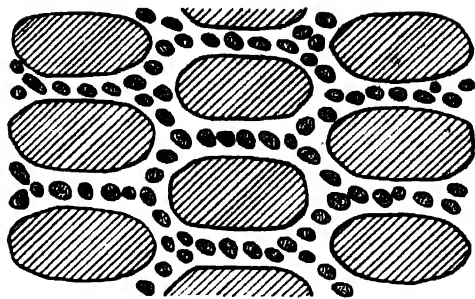

FIG. 2. SUBMICROSCOPIC, MICELLAR STRUCTURE OF CELLULOSE IN WALLS OF NATURAL FIBERS, AS PROPOSED BY C. NÄGELI (1877).

to propose the structure shown in Fig. 2. The introduction of a theory of crystalline structure here was, no doubt, suggested by the association between mineral crystals and optical anisotropy, known to physicists since the latter part of the seventeenth century. The idea, however, was a radical innovation, coolly received; the materials of plant life had been regarded as the epitome of the amorphous state. According to Nägeli's theory, rod-like crystals of cellulose, packed together as shown in Fig. 2, compose the fibrils which in turn compose a fiber. The axes of these crystals, or "micelles" as they were named by Nägeli, were supposed to be parallel to the fibril axis.

Micelles are beyond the limits of visual microscopy. Their existence was inferred on the basis of physical theory, and not directly observed. Later work confirmed the idea that cellulose is crystalline in some form. But, while birefringence can be examined by accurate methods, it was many years before Ambronn³ initiated an analysis of the anisotropy to which the double-refracting effect is due. He found that the difference between the ordinary and extraordinary refractive indices does not have a constant value, as is the case with mineral crystals, but depends on the liquid in which the fiber is immersed. This be-

³ H. Ambronn, *Kolloidzeitschr.*, 6: 222, 1910.

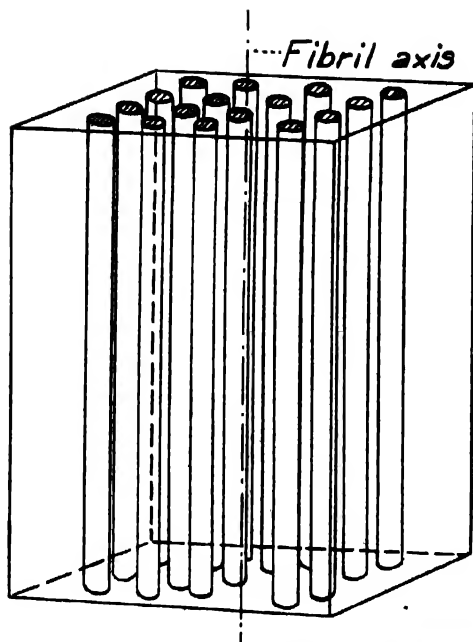

FIG. 3. RODLET MIXED SYSTEM. VOID SPACE (PORES) SURROUNDING THE CYLINDRICAL RODLETS IS PENETRABLE BY LIQUIDS HAVING DIFFERENT REFRACTIVE INDICES.

havior suggested that the fiber wall is porous, permitting the imbibition of liquid, which forms with the cellulose a "mixed system." Shortly after Ambronn's discovery, Wiener, an optical specialist, developed a complete mathematical theory of mixed systems.⁴ This theory confirmed the porosity hypothesis by showing that birefringence results if the propagating field contains parallel rodlets of material having a refractive index different from that of the surrounding medium and a diameter smaller than the wave-length of the incident light. In Fig. 3 is shown a section of the idealized fiber wall which served as the mixed system analyzed by Wiener. In the present application, the rodlets are to be regarded as continuous masses of cellulose corresponding to Nügeli's micelles. In accordance with this explanation, when there is no difference

⁴ See footnote 2.

between the indices of the two components of the mixed system the birefringence disappears, since the system becomes homogeneous. As a matter of fact, Frey⁵ much later reported an experiment in which the cellulosic fiber itself was made to disappear when observed under a microscope, by employing penetrating liquids having appropriate refractive indices.

The rodlet birefringence discovered by Ambronn is, however, a second-order effect. In cellulose this effect is obscured by the more pronounced double refraction which arises from the intrinsic anisotropy of the cellulosic rodlets. Thus, while Ambronn and Wiener's work demonstrated quite conclusively that native cellulose has a structure of pores and rodlets along the lines of Nügeli's micelles theory, it did not invalidate the latter's assumption that the micelles are crystalline. It is not to be inferred that the micelle is now regarded as a single straight rodlet extending continuously through the fiber, as Fig. 3 might suggest. The structure shown here is a simplification of what modern theory holds to be the true structure.

To get a better idea of the real fine structure necessitates a study of the interior of the rodlike micelle. To this study the method of x-ray diffraction

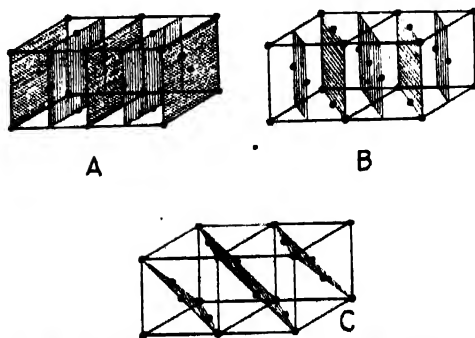

FIG. 4. SYSTEMS OF PARALLEL PLANES THROUGH A FACE-CENTERED CUBIC LATTICE.

⁵ A. Frey, *Kolloidchem. Beihefte*, 23: 40, 1927.

has been applied. It has been shown, as earlier theory had predicted, that there exist in the cellulosic mass submicroscopic crystallites, *i.e.*, regular lattice arrangements of atoms and molecules.

II. CRYSTAL ANALYSIS BY X-RAYS

The atoms regularly disposed in a crystal lattice define a large number of planes with various orientations in the crystal. In Fig. 4 some of the principal layers of atoms are indicated for one type of structure, namely, a cubic lattice. When x-rays fall upon such a crystal lattice they are scattered in all directions by each of the atoms in the various planes. However, interference takes place and causes the diffracted rays to have only the directions given by mirror reflection of the incident rays from the various planes of the lattice. In accordance with the Bragg law, well known to physical scientists, these directions are functions of the wave-lengths of the incident rays and the distances between the layers of atoms in the lattice.

Let us suppose that a beam of x-rays is passed through a thin single crystal of calcite and falls on a photographic

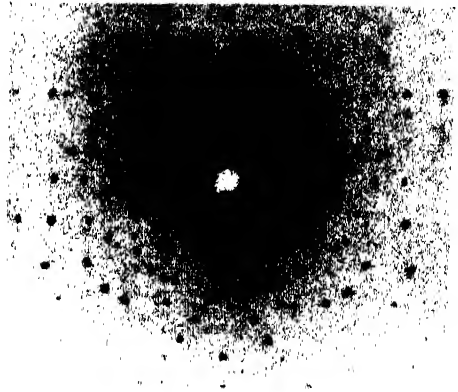

FIG. 5. LAUE PHOTOGRAPH OF CALCITE (CALCIUM CARBONATE). THE WHITE SPOT MARKS THE POSITION OF THE UNDIFFRACTED PRIMARY BEAM. (FROM ASTBURY, "FUNDAMENTALS OF FIBRE STRUCTURE.")

plate to form a so-called Laue pattern. There would be obtained on the plate an array of distinct spots such as is shown in Fig. 5. Each of the Laue spots (those outside the large central spot) is a diffraction maximum resulting from a particular set of planes in the crystal. From a geometric analysis of a Laue photograph much information about the type of the crystal and some idea of interplanar dimensions can be gained.

The crystal we have been considering could very well have been a thin square, *i.e.*, one having its length and width about equal and 5 or 10 times the thickness. Suppose a crystal thousands of times longer than it is wide and thick were chosen. Such a single crystal is supplied by the silicate, asbestos. If an x-ray pattern of such a single, fiber crystal could be obtained with a band of wave-lengths it would be found that it consisted of an array of spots of the type shown in Fig. 5. It is possible to obtain another type of pattern, however, if, instead of a single asbestos fiber, a bundle of such fibers was used with x-rays of a single wave-length. In this way the photograph in Fig. 6 was obtained. The pattern is symmetrical

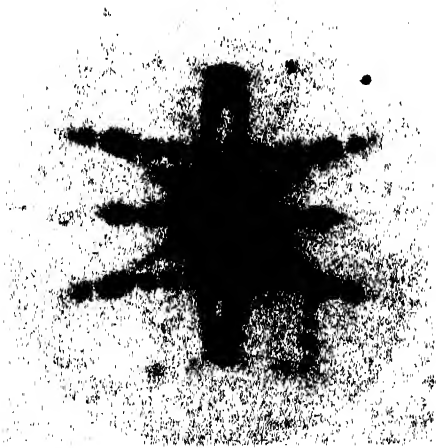

FIG. 6. X-RAY FIBER-BUNDLE PHOTOGRAPHS OF ASBESTOS. (FROM ASTBURY, "FUNDAMENTALS OF FIBRE STRUCTURE.")

about a vertical line corresponding to the vertical axis of the fiber bundle. The spots all lie on hyperbolae whose common axis is parallel to the longitudinal axis of the long crystals. This axis is the only crystallographic direction which has common parallelism among all the fibers. The other crystal axes are disposed at random. The orientation in three orthogonal directions which existed in the first calcite crystal has been degraded to orientation along only one line. The x-ray pattern reflects this condition in the

repetition of spots along the hyperbolae. Again the directions in which the x-rays have been reflected can be deduced, and, applying the Bragg law, the distances at which the atomic pattern is repeated in directions parallel and transverse to the fiber axes can be calculated.

This last remaining degree of orientation can be destroyed by pulverizing a crystal into minute grains. If x-rays are passed through the resultant powder a Debye-Scherrer pattern is obtained, such as that shown at the bottom of Fig. 7. This figure represents the pattern of pulverized sucrose, showing the concentric rings which characterize a powder diagram. The orientation of the granular crystals is now entirely random, so that no direction perpendicular to the incident x-ray beam is distinctive. The spots which appeared on the diagram of a single crystal of sucrose, shown at the top of Fig. 7, have spread out into circles about the center. The presence of these rings in an x-ray diagram indicates that the atoms or molecules composing the structural units are arranged on a crystal lattice, but that these units themselves are not oriented.

The relations between the structure of the sample and the x-ray pattern, which have been noted here for materials whose crystallinity is indubitable, are important in the interpretation of the x-ray diagrams of cellulose. This idea was employed as far back as 1913 by Nishikawa, a Japanese who obtained the first x-ray diagrams of a fiber. He noticed that there was a similarity between the symmetrical pattern of asbestos fibers and the patterns of some cellulosic materials. Though the latter patterns were not very clear, he concluded that cellulose must contain some kind of elementary crystals.

III. X-RAY STUDIES OF CELLULOSIC FIBERS

An x-ray diagram of native cellulose,

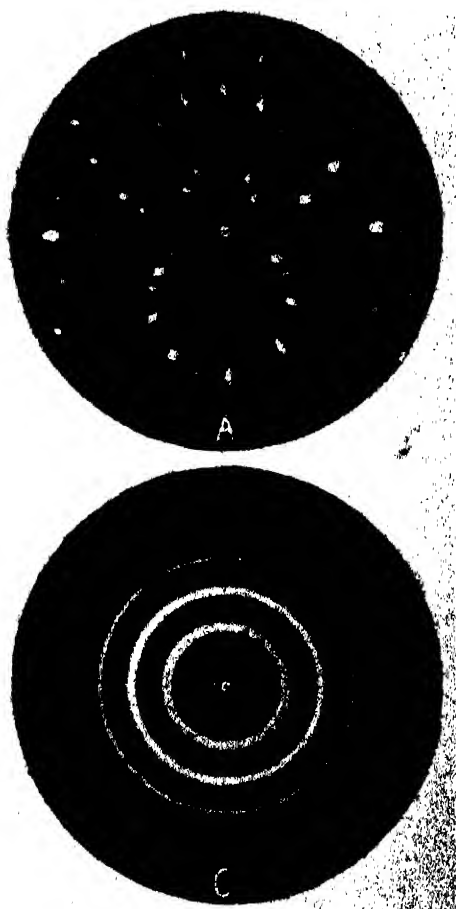

FIG. 7. EFFECT OF CRYSTAL SIZE ON X-RAY DIAGRAM OF SUCROSE. (A) CRYSTAL 1 MM. THICK; (C) PULVERIZED TO PARTICLES 0.001 MM. THICK. (COURTESY OF W. A. SISSON.)

the sample used being a bundle of mature cotton fibers, appears in Fig. 8. It is immediately apparent from the presence of the rings in the diagram that there are crystallites in the structure of this unstretched fiber. Further analysis leads to the conclusion that these are crystallites of cellulose. The extent to which the rings are concentrated in arcs indicates some degree of parallel orientation of the needle-like, submicroscopic crystals which produced the x-ray pattern. On measuring the angular width of the x-ray arcs (57 degrees), Sisson⁶ found that it was equal to the average divergence between the spiral fibrils, as indicated in Fig. 1. The conclusion is that the cellulose crystallites are packed in the fibril with their axes parallel to the fibril-axis, so that the crystallites run spirally around the fiber instead of straight along it.

When a cotton fiber is stretched are the fibrils stretched proportionately, or does the spiral simply become steeper, so that the fibrils and crystalline micelles become more nearly parallel to the fiber axis? That this latter takes place is deduced from examination of the x-ray diagram of stretched cotton fibers,⁷ such as that shown in Fig. 9B. The cellulose of the fibers here has been partially modified by treatment with sodium hydroxide (mercerization). In this photograph the arcs have shrunk further to become more nearly spots, and other short arcs have appeared. That is, the diagram is tending toward the spot-type produced by a bundle of asbestos fibers, which we saw in Fig. 6.

Turning now from cotton to another native cellulosic fiber, ramie, a still better x-ray diagram, Fig. 10, is obtained. In the ramie fiber the fibrillar spiralling

⁶ W. A. Sisson, *Contrib. Boyce Thompson Inst.*, 9: 239, 1933. Cf. also D. R. Morey, *Textile Research*, 4: 491, 1934.

⁷ W. T. Astbury, "Fundamentals of Fibre Structure," p. 88. Oxford University Press, 1933.

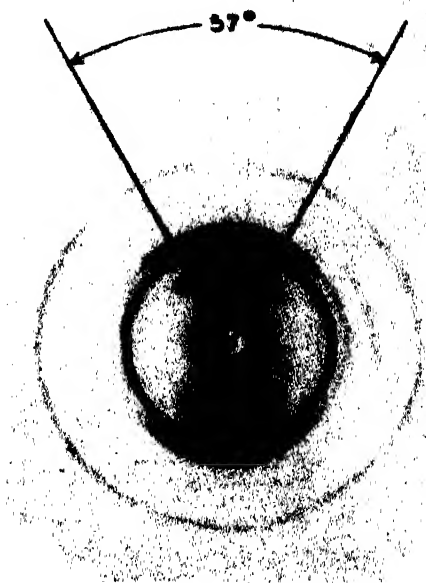
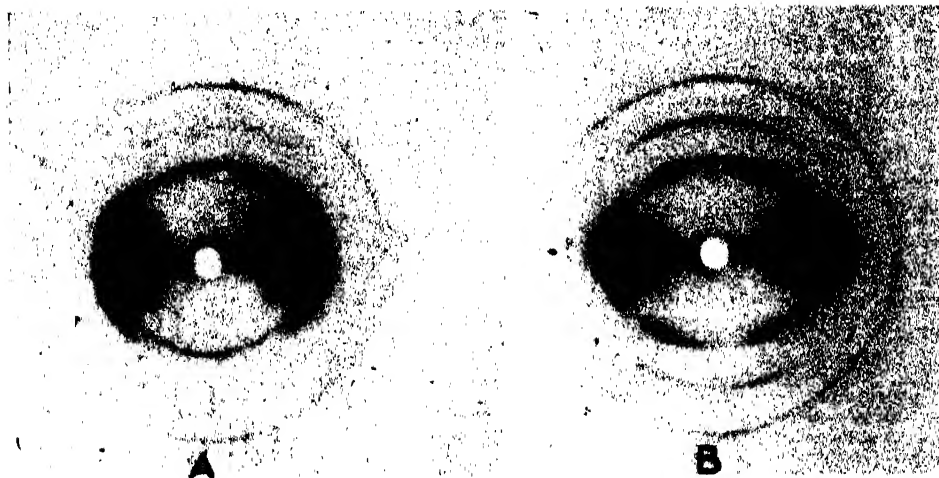

FIG. 8. X-RAY FIBER DIAGRAM OF UNSTRETCHED MATURE COTTON. (COURTESY OF W. A. SISSON.)

is negligible, so that the longitudinal axes of the crystallites should be parallel to each other and to the axis of the bundle. These expectations are confirmed by this pattern. The circles in the cotton pattern have disappeared, and the arcs have shrunk down to oval-shaped spots. From this type of spot, or "four-point" x-ray diagram of a cellulosic fiber, three sets of data are obtainable.

Firstly, the measurement of various distances between diffraction spots permits calculation of the separation between planes of atoms in the crystal lattice, as would be supposed from the Bragg law. Thus, it is possible to obtain the intervals at which the molecular, or multi-molecular, pattern repeats itself in all directions of the crystal. Measurements of this type reveal that the repeat-distance in the crystal of native cellulose, parallel to the fiber axis, is equal to twice the length of a glucose residue, as deduced from chemical data.



Courtesy of Earl E. Berkley.

FIG. 9. X-RAY FIBER DIAGRAMS OF A SINGLE SAMPLE OF COTTON: (A) FIBERS IN THE NATURAL UNSTRETCHED STATE; (B) SAME FIBERS AFTER BEING STRETCHED BY TENSION DURING MERCERIZING TREATMENT, AND THEN WASHED AND DRIED.

From this relation between the chemical unit and the crystallographic unit it has been concluded that the cellulose chain-molecules are arranged parallel to the axis of the native fibril.

Secondly, the intensity of the various diffraction spots provides a means for arriving at the number and kind of atoms in each of the planes to which the spots are due. The intensities are evaluated either according to relative rank by

visual observation, or according to registration in a photometer. The planes having the most atoms and the heaviest ones in general produce the most blackened spots. In cellulose these planes are those of the hexagonal pyranose rings, containing carbon and oxygen, so that the x-ray investigators have been able to orient these rings in the crystal lattice. Studies on simple carbohydrates indicate that these rings are quite flat.⁵

Finally, the width or sharpness of the diffraction spots gives an indication of the size of the crystallites from which the x-ray diagram arises. The relation between the width of the spots and size of the crystallites is inverse. It is evident that if the breakdown of a large single crystal into numerous crystallites has any significance, it will result in the reflections from the planes becoming less cooperative. The resultant spots on the photographic plate will be less confined and distinct. It is noticeable in Fig. 10 that the spots lying along the horizontal axis, or equator, near the center are

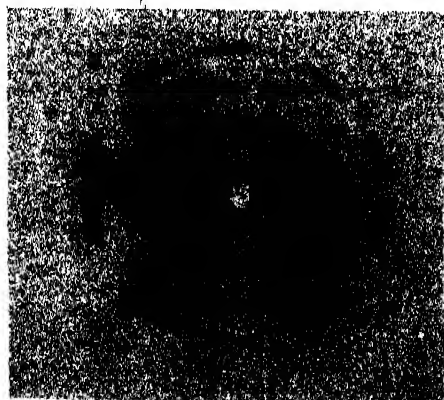

Courtesy of Earl E. Berkley.

FIG. 10. X-RAY FIBER DIAGRAM OF RAMIE, A NATURAL CELLULOSE FIBER.

⁵ Cox, Goodwin and Wagstaff, *Jour. Chem. Soc.*, 1495, 1925.

broader than those lying near the vertical axis, to which the fiber axis is parallel. The broadness of the equatorial spots is taken to indicate that there are fewer planes or layers of atoms parallel to the fiber axis than there are planes transverse to this axis. This condition, in turn, means that the tiny crystallites of which the fibrils are composed must be rodlike, *i.e.*, much longer than they are thick, and furthermore must lie with their lengths along the fiber axis.

The first adaptation of x-ray diffraction data on cellulose to the determination of the dimensions and character of the crystal unit was announced by Polanyi⁹ in 1921. Measurements of this type, and their interpretation in the light of chemical evidence, have since been refined. The latest revision of Meyer and Mark's model of the cellulose crystal unit appears in Fig. 11.¹⁰ Associated with the cellulose unit are two cellobiose residues, each containing two of the pyranose rings of glucose. These rings are connected along the b-axis by primary valence bonds to form the long-chain molecules. The a- and c-axes are transverse to the fibril axis, though not quite perpendicular to each other.

A quantitative interpretation has been made of the relation between spot- and crystal-size by Hengstenberg and Mark and others¹¹ to calculate the dimensions of the colloidal crystallites or micelles in a cellulose fiber. Their conclusion was that the micelle is at least 600 Å. long and about 50 Å. broad.¹²

The x-ray data, as they concern micellar size, are in agreement with the results of the optical studies. After reviewing all the data, Seifriz¹³ proposed

⁹ M. Polanyi, *Naturwissenschaften*, 9: 288, 1921.

¹⁰ Meyer and Misch, *Helv. Chim. Acta*, 20: 832, 1937.

¹¹ H. Mark, *Jour. Phys. Chem.*, 44: 764, 1940.

¹² 1 Å. = 1 Angstrom unit = 10^{-8} centimeters.

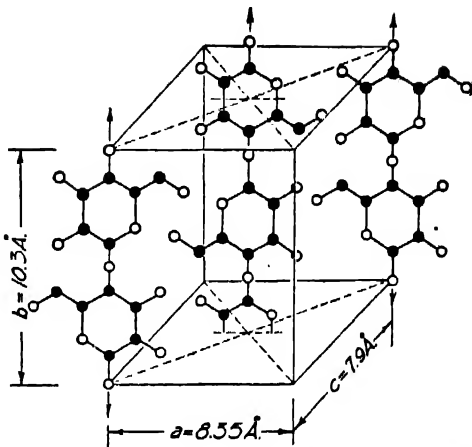

FIG. 11. CRYSTAL UNIT OF CELLULOSE, AS REVISED BY MEYER. BLACK CIRCLES REPRESENT CARBON ATOMS; HOLLOW CIRCLES OXYGEN ATOMS. THE LIGHT HYDROGEN ATOMS ARE OMITTED.

for native cellulose the structure shown in Fig. 12, in which the crystallites are packed like bricks in a wall. The cut-away section shows the atoms of the cellulose molecules composing the bricks. This neat structure is a revival of Nägeli's pattern. It was not intended to be complete, and accurate in every detail, but to represent the main features of the submicroscopic system of cellulose. Certain features are not consistent with more recent physico-chemical observations. For instance, values for the coefficient of viscosity of cellulose dispersions indicate that the average molecule of native cotton cellulose is 10,000 Å. long, while use of the ultracentrifuge has yielded lengths of around 18,000 Å. Obviously, molecules of these lengths could not be restricted to a single block 600 Å. long, without being folded back on themselves.

Concerning the relation between aggregates on the scale of the micelles which have been discussed, and the fibrils of cellulosic fibers, various theories have been advanced during the past fifty years. In general, these theories

¹³ William Seifriz, *Amer. Naturalist*, 63: 410, 1929.

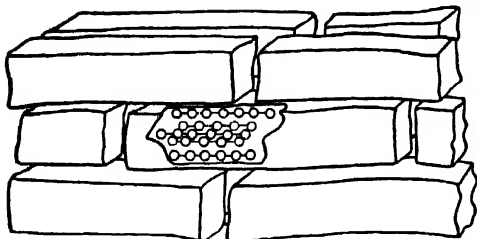

FIG. 12. SHARPLY-DEFINED CRYSTALLINE MICELLES IN NATIVE CELLULOSE, AS PROPOSED BY WILLIAM SEIFRIZ IN 1929.

involve the existence of intermediate units which, bound together in a ribbon-like structure, compose the fibrils. Wiesner first advanced the idea of such particles, which he termed "dermatosomes." On treating fibers with phosphoric acid, Ritter observed under the microscope fibrillar sections which he termed "fusi-form bodies."¹⁴ During recent years evidence has been introduced by Wanda Farr and her associates¹⁵ indicating that the basic unit of native cellulose is an ellipsoidal particle about 15,000 Å. long and 11,000 Å. across, somewhat larger than the particles proposed earlier. Whether these particles have objective existence as self-contained, basic units, or are indefinite, artificial aggregates of micelles is an unsettled question.

¹⁴ G. J. Ritter, *Ind. Eng. Chem.*, 21: 289, 1929.

¹⁵ Farr and Eckerson, *Contrib. Boyce Thompson Inst.*, 6: 189, 1934. W. K. Farr, *Jour. Applied Physics*, 8: 228, 1937.

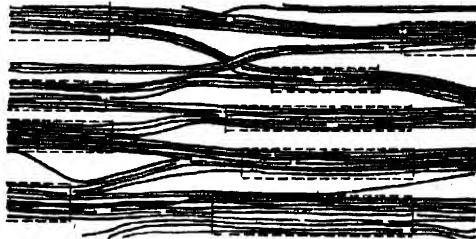

FIG. 13. NETWORK STRUCTURE OF ORIENTED CELLULOSE. MICELLES ARE INDICATED BY DOTTED LINES; EXCLUDED REGIONS ARE POROUS.

The concept of the fine structure of native cellulose most widely accepted at present is illustrated in Fig. 13. Here regions of micelles, depicted as somewhat vaguely defined, crystalline bodies, are separated by regions of porous or amorphous matter. The long-chain molecules of cellulose pass from one of these regions to another, somewhat at random, but always more or less parallel to the fiber axis. In the micelles the chains are well oriented;¹⁶ in fact, that supposedly is what makes the micelles what they are—crystallites. In manufactured cellulosic filaments, this orientation is generally lacking. In general, also, stretching improves the orientation in both the natural cellulosic fibers and the filaments manufactured from cellulose.

¹⁶ O. Kratky, *Angewandte Chemie*, 53: 153, 1940; translated by Julian F. Smith in Hooker Scientific Library Cellulose Series.

ADJUSTABILITY OF THE LIFE PROCESS TO INJURIOUS AGENTS¹

By Dr. WM. deB. MACNIDER

KENAN RESEARCH PROFESSOR OF PHARMACOLOGY,
MEDICAL SCHOOL OF THE UNIVERSITY OF NORTH CAROLINA

LIKELY the most constant characteristic of the life process is its inconstancy, not its inconsistency. What may appear as inconsistency in it is due to our inability to understand and appreciate the most fundamental attribute of life—change. The natural tendency of a mind is to classify, to card-index individuals, processes which take place in them, even situations and circumstances, for this is the easy way. It has in it an element of permanency, it tends to be static: again, it is the easy way. Through such a card-indexing we may put down and fix even a thought to come back to it at will and find it where we placed it. The life process has nothing of fixity to it: it is indicated by change, genetic change, cellular change and the ever changing nature of the chemical constitution of life, constituting as it does morphology in an attempt at adaptation and balance. Through change a balance must be achieved in the life process to enable it to relate itself and move without friction as function. A failure of cell adaptation to a changing normal and frequently to an abnormal environment ultimately results in such a degree of maladjustment that useful life becomes impossible. This life goes by "fits and starts," it lacks a smoothness, translated as purposefulness, and its end is death. It therefore becomes the function of the "biologically minded physician" to realize and attempt to understand the significance of physical and chemical change in the organism and in

¹ The last in a series of three articles on "Tissue Susceptibility and Resistance" contributed by the author.

turn institute those measures which will further the processes of adaptation. Such natural processes operating over periods of days, and also over geological periods, may result in changes in form significant for transitory or permanent adaptation. Even ephemeral states of a functional order, such as fever, an increase in the number and activity of wandering cells, may be of a purpose tending towards tissue adjustments.

Hippocrates realized the significance of change in surface form. The narrow-chested, pale and blonde individual with "winged scapulae" to him in his wisdom was a type or form of individual in which tuberculosis was apt to develop. These observations dealt with form and changes in form as they departed in form from that which to him was normal and related. Later than this the anatomists, some of whom were to be later designated pathologists, were permitted to observe and study organs within the dead and unrelated body so they might ascertain once again in the gross what were those changes in this or that organ designated diseased states which unrelated the individual to his environment, which prevented adaptation and which resulted in death. Centuries later than this, when the use of the microscope became available for the hands and through the mind of Virchow and Cohnheim, more particulate observations were made possible. Tissues and organs were found to be made up of units designated cells, and the cell became the structure to consider as influenced by the normal and the abnor-

mal process. As a result of Virchow's great work we were enabled to penetrate into the hitherto unseen; from the surface observations of Hippocrates, the later gross observations of the anatomists and pathologists as to organ change expressing faulty adaptation, to a new realm of cell change; cell change in terms of microscopically demonstrable change. Until recently we have had to remain in this domain of understanding, of incomplete understanding of the processes of cell life translated through cell form.

As a result of the studies of the microscopic anatomists we have been given what they consider accurate, measurable information concerning normal cells of various types. Such normal cells are not infrequently seen as fixed entities lacking the elasticity necessary for change and adaptation under the strain of normal life, and especially when that life becomes so abnormal that change of a major order must take place in order for such an emergency in life to be checked and adjusted. Such adjustments are made even in the normal, not through gross morphological change, but by a chemical and physicochemical order of change which in the abnormal may assume such proportions as to express the aggregate of chemical change as altered morphology. With such a conception it becomes unwise to assume fixity in cell form as representing a given normal and that any departure in form from this hypothecated normal a manifestation of disease, a cellular adventure towards dissolution and death. On the contrary the chemistry of life within the cell must change quantitatively and in its rate and degree of completion, and the form of cells may shift in normal life through these changes, and do change in abnormal life, not for death, but for adapted life with fair function and one which, even though it be adapted at a lower level of functional

effectiveness, has acquired through cell change and the chemical changes within the cell an element of resistance against further change of a degenerative nature.

Such thoughts make it difficult for one to determine just what disease consists in. Just where does cell change for adaptation and life cease and cell change for death commence? Liver cells and kidney cells of normal adult animals have been shown to be highly susceptible to an influence exerted by substances such as uranium nitrate, chloroform and ether. At such age periods this susceptibility which must be of a chemical order as affinity enables these cells to change under such influences. We speak of these alterations as disease because they tend to unrelate an adapted organism. Cells in the same locations in these organs in puppies and young adult animals fail to show such changes. They have a chemical constitution which prevents or lessens such changes, and we are satisfied to label such cells normal cells because of their resistance. On the contrary the same type of cell in the same location may so react to injury designated disease that it not only changes its form and chemical constitution but associated with the change becomes resistant and maintains life when it is subjected to these injurious agencies. These are entirely different cells from those we have labeled normal. Should such cells be called diseased cells, or should we see them from a broader biological point of view, a more elastic and changing point of view, as constituting a tissue which has so participated in a stream of life induced by a chemical affording a difficult chemical environment, and which have survived through adaptation to this environment and thereby make their contribution, not only to organ survival, but through such a localized tissue resistance, to survival of the organism as a whole. This approach to tissue changes and to chemical

changes within a living organism as a whole should give us pause in our eagerness to employ artificial agents in order to hasten the bringing back of the organism to what we hypothecate is the normal for it in a given situation. Adaptation which leads to stabilization finds "success in the silences" and is often not of a rapid order of development. The normal for any living organism is not a fixed and static normal, but an ever changing normal. Cell changes of designated degenerative order and the chemical background for them may be considered as a part of a process which may lead to chemical shifts and morphological alterations resulting in life with acquired protection.

To this point in our discussion we have spoken of form and changing form, and through such a consideration have advanced from a concept of surface form to normal and pathological organ form in the gross, and finally to microscopic cell form. The discussion has not concerned itself with those chemical configurations within cells responsible for their change in form and in chemical affinity. The time has now come for the biological chemist and the physical chemist and that composite of the two, the pharmacologist, to advance through the spade work of the anatomist and pathologist, to within the cell and through the fluid which bathes it in such an intimate fashion, for an understanding of those chemical processes of a normal order, of a pathologically destructive order and lastly of an order which permits adaptation with sufficient function for survival.

In addition to such considerations of cell change and inferred chemical change which permits shifts in life with or without resistance, there may occur in an organ such as the kidney changes of a grosser microscopic nature which appear to be structural expressions on the part of such an organ to survive sec-

tionally as a functional entity. In a previous discussion^{2,3} of the kidney injury which develops from the use of uranium nitrate it was pointed out that in one form of adjustment as a repair process, the proximal convoluted segment of the tubule became relined by a very flattened and atypical type of cell. In some locations these cells or syncytial structures are flattened to a degree as to take on the appearance of an endothelial relining rather than one of an epithelial character. Such changes require several months for their development. This alteration can not be looked upon as a degeneration. It is a product of repair with the formation of a new structure with normal staining reactions. At the same time such changes are developing in the epithelial tissue of the tubule the glomeruli undergo gradual changes, secondary to the acute injury, which results through the formation of connective tissue in a gradual and uneven obliteration of the glomerular capillaries. Months before such obliteration becomes complete it is usual to find glomeruli which are no longer capillary structures, but canalized structures. The number of such vascular canals lined by endothelium and containing blood is variable, depending upon the extent of the connective tissue obliteration to which the glomeruli have been subjected. When such kidneys are injected with a colored mass through the renal artery prior to the animals' death the injection mass is found to pass through such glomerular canals and localize itself in terms of quantity in the second set of capillaries in the region of the proximal convolution which is now lined as a result of repair by extremely flattened cells. Blood, therefore, passing through such canalized glomeruli, is so placed that it may be acted on or

² Wm. deB. MacNider, *Jour. Exp. Med.*, 49: 387, 1929.

³ *Idem*, *Jour. Exp. Med.*, 49: 411, 1929.

exert its influence through such very atypical tubules of a repaired and surviving order. Not infrequently the broad lumen of such tubules lined by extremely flattened cells shows an indentation or commencing invagination of its wall through capillary pressure from without, inward. It is interesting to conjecture whether or not such a gross alteration in renal architecture is not leading to the formation of a modified type of glomerulus with in part a maintenance of glomerular function by filtration through an atypical segment of the tubule below the now inactive glomerulus. Embryologically it should be recalled that glomerular formation develops by just this type of process through capillaries invaginating a tubular segment. An ontogenetic process may exert its influence in organ survival when such organs are subjected to slow but progressive injury. In other areas of such injected pathological kidneys the colored injection mass may be followed through the medulla of the kidney, into the cortex and become localized in capillaries around tubules repaired with flattened cells in areas in which complete glomerular capillary obliteration has taken place. Such glomeruli are no longer canalized. These structures have become obliterated by fibrous tissue formation and an associated hyalinization of this tissue. An agglomerular structure has been formed through injury with the atypically repaired and

resistant part of the nephron receiving blood for purposes of nourishment and possibly for function by an ingrowth of capillaries from below. The composite repair process in this instance has resulted in the formation of a structure phylogenetically of a normal order for the agglomerular fishes.⁴

These examples of changes in the form of structures as a whole (the renal nephron) as well as changes in cell form, and finally in the changes of the chemistry of such cells impress one with the extent to which tissue changes may go in order for cell function and organ function, modified as they may be, to persist in an adapted state and so effect the survival of the organism as a whole.

From this discussion the significance of change, of change as a characteristic and function of life is apparent. The continuance of life depends upon the elasticity and adaptability of its nature determined by chemical and physicochemical forces of an order of which we are in large measure ignorant other than the dominating genetic factor. Such an admission offers a broad field for investigation into the life span of any species of animal or plant in which the element of change is the outstanding characteristic of life as normal adapted life, as maladjusted abnormal life, and as life as it passes from birth through successive modifications, finally terminating with death in senility.

⁴ *Idem. Proc. Soc. Exp. Biol. and Med.* 31: 293, 1933.

THE YOUNG NATURALISTS' SOCIETY

By Dr. C. JUDSON HERRICK

PROFESSOR EMERITUS OF NEUROLOGY, THE UNIVERSITY OF CHICAGO

I. IN THE BEGINNING

Two fifteen-year old boys sat together at one of the old-fashioned desks of the Jefferson Public School at 10th Street and Hennepin Avenue, Minneapolis, during the school year of 1873-74. Tom lived in town, but Clarence walked every morning from an outlying farm and was often tardy. The boys quickly became intimate, for they had many interests in common and Clarence had no other playmates. Of course they must not whisper, but there was so much to tell that Clarence fell into the habit of sketching on his slate a pictorial record of his activities since yesterday—milk-ing the cow in a swarm of flies, gathering potato-bugs or husking corn. The teacher (who evidently had no sense of humor and little of any other sort), noting something unusual, one morning called Clarence to his desk with the slate. On seeing the pictures, which were both realistic and fantastic, he gave the boy a severe whipping. Clarence returned to his desk with a smarting palm and a smiling face and refilled the slate with caricatures of the teacher.

The following summer these boys with two other schoolmates camped on an island in Lake Minnetonka, and here the interest in birds and all other wild life which hitherto had captivated their childish minds now became a ruling passion which endured and shaped the whole subsequent courses of their lives. This camp was probably the seed-bed within which the Young Naturalists' Society germinated. Tom, with rare pertinacity, clung to his first love, the birds; but Clarence's interests, appar-ently from the dawn of his interest in

anything, were spread over the whole face of nature.

In September of that year, 1874, these boys entered the Minneapolis high school, where during the three-year course and for some time thereafter their exploits as "Young Naturalists" were so original and productive as to merit description. A record of the activities of these young pioneers written week by week with their own hands has fortunately been pre-served, and these yellowed pages contain something of historical interest and much of inspirational value for us of a later generation.

Through the kindness of Dr. Thomas S. Roberts, director of the Minnesota Museum of Natural History in Minne-apolis, these papers have recently come into my hands. They are of interest for two reasons: first, they document a critical period in the history of science in the upper Mississippi Valley, embrac-ing the years 1875 to 1878; second, they give illuminating glimpses into the inti-mate lives, habits and mental furnishings of a small group of exceptional children whose spontaneous interest in natural history came to expression in the formal sessions of their society. Here we see the quickening and operation of scientific interest in the minds of sixteen-year old boys and remarkable industry and originality in the cultivation of these interests. The cultural background and historical development of their commu-nity in 1875 have been outlined in a previ-ous article.¹ Extracts from these docu-ments are presented with some commen-tary. Two of the three promoters of this

¹ C. Judson Herrick. *Scientific Pioneering in the Middle West*. SCIENTIFIC MONTHLY, Vol. I, pp. 49-56.

society are now living in Minneapolis and they have given me interesting details which supplement the written record.

II. ORGANIZATION AND PROCEDURE OF THE SOCIETY

On the 12th of February, 1875, seven boys organized the "Young Naturalists' Society," whose records show continuous activity until November 18, 1878. These boys were members of the first-year class of the Minneapolis high school. There were some later additions and some withdrawals, but the number of members remained about the same and four or five of them were active throughout the life of the society. These included Thomas S. Roberts, Clarence L. Herrick, Robert S. Williams and Frank P. Clough, son of the city engineer at the time of threatened disaster to the Falls of St. Anthony (1869 to 1876). Regarding the inception of the society, Dr. Roberts writes me:

The nucleus consisted of Clarence, Robert S. Williams and myself. I was the promoter and furnished the place of meeting—my bedroom. This was on the second floor, reached by a side entrance, through the diningroom and up a back stairs. It was heated by a little drum stove and provided with storage arrangement for specimens, etc. Here we assembled and sat around in earnest conclave, for we were a serious bunch. Our youthful friends of different minds were wont to poke fun at us by sending us bogus specimens from time to time. But we went gravely on our way. Clarence did the best work.

It is an important point, here reiterated, that neither the society nor any of its members had any significant contacts at school or elsewhere which might encourage or guide their activities before the end of September, 1875. During the following two school years Mr. Roberts continued in the high school, graduating from the three-year course in 1877. But Clarence left the high school to enter the preparatory department of the university. The official records of the University of Minnesota show an application

for admission by his father dated Sept. 28, 1875, "for 6 years." Beginning in the autumn of 1875, he attended four years and two quarters, graduating with B.S. degree in June, 1880, thus completing the six-year course in less than five years. His competence as a naturalist very soon was recognized, for within less than a year of matriculation he was appointed assistant to Professor N. H. Winchell, director of the Geological and Natural History Survey, and his extracurricular activities in the Survey probably were of greater educational value to him than any of the regular courses. This influence was perhaps similar to the help which the young G. H. Parker received from the Academy of Natural Sciences in Philadelphia, as recorded in an autobiographical note.²

Robert Williams also came under Professor Winchell's influence at some time during the active life of the society. He did not graduate from high school and probably entered the preparatory department of the university, for in a recent letter to me he writes:

I first took up an interest in birds and began making skins and trying to mount them along with other boys in the neighborhood. I paid little attention to plants until attending the Minnesota University for a short time. I had to pass an examination on local plants and make a collection of fifty specimens. This I did and received 100% on it from Prof. Winchell.

It is obvious that from the date of Clarence's matriculation at the university in the autumn of 1875 this connection with an organized scientific program was a significant help to the society and all its members; yet this certainly was not the source of its initial motivation. In origin it was parthenogenetic, not sired by any outside person or influence; and its form and procedure were not sensibly changed during the later years when Clarence was Professor Winchell's assistant.

² G. H. Parker. *Frontiers*, Philadelphia, January, 1937.

That they had access to books is evident, and at first these were probably drawn largely from the public Athanaeum library, later no doubt from the university library. That they used the available literature to good purpose will appear shortly. For other equipment they were dependent almost entirely upon their own resources, for there was little money except from the small monthly dues and fines.

Among the spoils of war brought home by Clarence's father from his Civil War campaigns was an old Springfield army rifle which had done heavy duty at the front. Heavy duty is right, for none but a husky man with good teeth could manage this clumsy piece of ordnance. The strong paper cartridge containing the leaden bullet and a charge of black powder was torn by the teeth, inserted in the muzzle and then rammed home, to be discharged by a percussion cap. The recoil was terrific and the execution out in front was appalling if the rifle-ball met its target. This ancient weapon, with the rifling of the barrel reamed out so as to transform it into a muzzle-loading shotgun, was Clarence's only equipment in the early days of his collection of birds and mammals. With a light charge of small birdshot and due attention to the erratic disposition of sights and scatter, he usually contrived to bring down the smallest bird in perfect condition. But not always, and I well remember his rage when a rare specimen fell as a mangled wreckage of blood and feathers.

During Clarence's high-school days his father out of his poverty bought him an eight-dollar microscope. There were no such refinements as coarse and fine adjustment, merely a tube sliding in a sleeve for focussing. But the lenses were good, and with that crude instrument he explored the fauna of ponds and ditches so diligently and productively that, of the three short papers

prepared for publication before he entered the freshman class at the university, one was entitled, "A New Cyclops." These papers were published in 1877, the others being, "Ornithological Notes" and "The Trenton Limestone at Minneapolis."³ The minutes of the Young Naturalists' Society show that these papers were prepared for the society and read at regular sessions; and the range of subjects which they embrace is typical of the catholicity of interests cultivated by these youngsters.

Meetings of the society were held in the evening, at first weekly and later biweekly throughout the year, including the summer months. Mr. Roberts was the first president, and he was reelected for the following term also. In his "Report of the Secretary of Young Naturalists' Society" for the six months ending January 14th, 1878, he writes:

Since March 12, 1875, one hundred and nine (109) regular meetings have been held, all of them with the exception of one or two in this room. Twenty-six (26) regular meetings were held during the past year. . . . March 5th the regular monthly tax which had been 10c was reduced to 5c which it still remains. . . . There are in the society's possession forty-four (44) original papers written by its members, and eight (8) reports. The papers were mostly read during the year 1875 and the first part of 1876. Some if not all of these would probably bear rereading and general criticism.

One of the primary objectives of the society was the preparation of accurate lists of the local fauna and flora. In Secretary Roberts' report at the end of the third year he writes:

The ornithological list since it now numbers one hundred and ninety-four (194) out of a possible three hundred (300), does not increase very rapidly. Four (4) new species have been handed in during my term—vis.; the Blue-gray

³C. L. Herrick. "Ornithological Notes." Fifth Annual Report of the Geological and Natural History Survey of Minnesota (for 1876), St. Paul, 1877, pp. 230-237. "A New Cyclops." *Ibid.*, pp. 238-239. "The Trenton Limestone at Minneapolis." *Am. Nat.*, Vol. 11, pp. 247-248, 1877.

Gnatcatcher (*P. caerulea*), by R. S. Williams, and the Gray Snipe (*M. griseus*), Ring-billed Gull (*L. delawarensis*.) and Leconte's Bunting (*C. lecontei*) by C. L. Herrick. Two of these are especially noteworthy; the Blue-gray Gnatcatcher on account of its occurrence so far north, it being essentially a southern species; and Leconte's Bunting, from its general rarity and meagre history. Several other new species have been taken but not yet entered upon the list.

More work has been done in Botany than in any other branch; at least the results are larger; but this is to be accounted for in great part by the field being new and large. The names of the plants identified were at first kept in the form of a wholly unclassified list. By the time a hundred and fifty (150) species, or only one summer's work had been thus entered it was found that the list was rapidly becoming unmanageable. . . . In the scattered condition of the list just at present I cannot say how many species have been identified but think the whole number closely approximates five hundred (500).

The list in Paleontology contains fifty (50) species the result with but two (2) exceptions of the work of Mr. Herrick. The Entomological list includes 31 species. But few additions have been made lately. The last is the Zoological or miscellaneous list which contains thirty-one (31) species, covering mammals, reptiles, and fishes. These in due time will find their proper places when lists in their respective departments are started.

These lists were never published, save for a list of birds⁴ and a reference to a list of plants in Warren Upham's Flora of Minnesota.⁵

The constitution of the society has not been preserved, though its salient fea-

⁴ "Ornithological Notes" by C. L. Herrick in the Fifth Annual Report of the State Survey, already cited, include a list of 91 birds added to the collection of the University Museum, where they still are. Most of these were collected in the summer of 1876. There are annotations upon some of the rare or atypical specimens and their parasites.

⁵ Warren Upham's "Catalogue of the Flora of Minnesota," published in the Annual Report of the Survey for 1883 (Minneapolis, 1884) has the following statement on page 10: "A list of about 500 species, observed chiefly in the vicinity of Minneapolis by the Young Naturalists' Club, was communicated by Mr. Thomas S. Roberts, by whom nearly all of these species were determined, others by Clarence L. Herrick, F. S. Griswold, and R. S. Williams."

tures are summarized in one of the Reports quoted beyond. It evidently received very serious consideration, for the minutes record repeated revisions. Officers were elected for a term of six months and comprised a president, vice-president, treasurer and secretary, besides standing committees on ornithology, entomology, botany, geology, conchology and physics. The usual order of business included a roll-call, reading of minutes and presentation of original papers and assigned readings, followed by general discussion. Formal debates are reported upon these, among other topics:

The state of the interior of the earth.

Which have the greatest influence upon agriculture—birds, insects or rodents?

Have birds and animals more than instinct?

Which has the greatest influence upon the form of a country—water in a flowing condition or all the other influences combined?

The relative importance of the natural sciences among the sciences.

The list of assigned readings as recorded in the minutes reveals some of the sources available to these boys and more about the range of their interests. The following are selected from a larger number:

Selections from Audubon; Marsh's "Man and Nature"; Geography and Evolution; Form and Life; The Stone Age; Frauenhofer's Lines; Vortex-atom Theory; Insectivorous Plants; The Flight of Birds; Cause of Earthquakes; The Great Auk; Influence of Habitat on Animals; Croll on "Climate and Time"; The Relation between Sunspots and the Price of Wheat; The Difference between Eastern and Western Birds; Theory of LaPlace—Creation; Rise and Progress of Modern Views as to the Antiquity and Origin of Man (A. R. Wallace); How Plants are Fertilized by Insects; Localization of the Functions of the Brain; Wild Mice and their Ways; Fertilization of Orchids; Transmission of Excitations in Sensory Nerves (Paul Bert); Theory of Tides; Song Birds of America; Obituary of Professor Henry; Intellect in Insects; Insect Wings; Structure and Affinities of Hummingbirds; Variation in Nest-building.

These topics have a modern ring in 1942, and this is what these high-school

boys were reading and thinking about more than sixty-five years ago.

The original papers were carefully written and filed in the Archives. Some were illustrated by drawings, specimens or experiments. These papers were not digests or reviews of literature; it was expected that each one of them should report original work of some sort. Lectures delivered extempore were apparently discouraged, for we read in the minutes of November 25, 1875, "Mr. Herrick was allowed to extemporize. Subject, The Cyclops." It is reported, however, that during the third year few original papers were written and there were seven unwritten addresses. Here are some of the titles taken from the minutes:

Essay by Clarence Herrick.

List of birds presented by Mr. Roberts. This entry appears frequently throughout the record; also lists of flowers.

List of insects presented by Mr. Herrick.

List of fossils by Mr. Herrick.

Essay on Our Winter Birds by Mr. Roberts.

The Balance of Nature by C. L. Herrick

Remarks upon a blackbird by the President (Mr. Herrick).

General discussion upon capillary attraction and cause of circulation of sap in plants.

Discussion about making a dredge.

Extemporaneous speech on some of the most noticeable animals in a bucket of water by Mr. Herrick.

Papers by Mr. Roberts on The Hummingbird, The Swallows, The Scarlet Tanager, The Least Bittern, The Nesting of Robins, Algae.

Papers by Mr. Williams on The House Wren, The Wax-wings, The Brant.

Entomostraca by Mr. Herrick.

Mimicry among Animals by Mr. Roberts.

III. THE RECORDS

The documents relating to the Society which have been preserved are as follows:

1. Minutes as written by the secretaries from March 5, 1875, to November 18, 1878.

2. Mr. Roberts' first president's report, July, 1875.

3. Eight semiannual reports by the secretaries and treasurers at the close of their terms.

4. Six reports for the term ending December

31, 1876, by the committees on Entomology, Ornithology, Botany, Geology and Mineralogy, Conchology and Physics.

5. An ornithological report addressed to Dr. P. L. Hatch, State Ornithologist, dated March, 1878, and recording observations made during 1877 by Thomas S. Roberts, Robert S. Williams and Clarence L. Herrick.

6. The manuscripts of five original papers by Frank Ham, eight by C. L. Herrick, two by Robert S. Williams and one by T. S. Roberts. These sixteen papers are all that have survived from the forty-four reported as on file in the archives of the society in January, 1878.

7. Many letters by members of the society or relating to it.

The documents here listed are now filed in the library of the State Museum of Natural History, Minneapolis, Minn. Many of the specimens collected by the society are preserved in the same Museum.

These documents will now be reviewed and annotated. In the quotations from them which follow the original form, punctuation and spelling of words are scrupulously followed. Most of these boys were weak in spelling, and in the case of at least one of them (Herrick) this disability persisted as long as he lived. The present writer is not inclined to be very censorious about this; for to this day, despite the reading of many thousands of pages of proof over a period of fifty years, he still finds it necessary to keep a dictionary at his elbow—not for technical terms, but for the common words.

IV. MINUTES OF THE SOCIETY

The original copy of the Minutes is a foolscap folio of 58 closely written pages. Most of the entries are neatly written in ink and some are in pencil. The first entry is undated and probably is of March 5, 1875, for the next entry is dated March 12 and the succeeding meetings follow at weekly intervals. The secretary's record of the meeting first reported is typical of those which follow.

"Reading by Mr. Scott, 'The Bladderwort.' Essay by Mr. Clough, 'Metamorphosis.' Reading by Mr. Williams, 'Spiders.' Essay by

Clarence Herrick. Remarks upon the fluctuations in Bassets Creek. List of Birds presented by Mr. Roberts. List of Insects presented by Mr. Herrick."

The program of June 12 of that year included a paper by Mr. Clough and "a paper read by C. Herrick in place of reading as was assigned." Mr. Roberts handed in lists of birds and flowers.

At the first meeting of the second half-year, July 2, 1875, officers for the next term of six-months were elected: President, Mr. Roberts; Vicepresident, Mr. Williams; Secretary, Mr. Herrick; Treasurer, Mr. Clough. On July 9 the President reviewed the history of the society and the Treasurer's report showed receipts of \$5.15 (dues \$4.55, fines for absence or failure to meet assignments \$.60), expenditures of \$1.40, and cash on hand, \$3.70. There is no record of an audit or comment on the apparent discrepancy in the cash account. An examination of the itemized Report separately filed reveals an error in subtraction.

On July 28, after a reading by Mr. Williams on "Animalism in Plants," Mr. Roberts presented a paper on "The Scarlet Tanager." It was then voted to purchase a case of drawers for the preservation of specimens. That the discussions were animated and often prolonged is indicated by the minutes of a meeting in December, 1875:

"Society called to order by the President. Minutes read and corrected. Parts assigned. The reading of Mr. Clough omitted as he was not prepared. Reading by Mr. Ham — Fleas & Bugs. Paper of a week ago read by Clarence Herrick. Notice of two amendments given by Mr. Herrick. Mr. Leon Lum admitted as member of society. All the members signed the constitution. List of several insects handed in by Mr. Ham. The name of one new bird presented by Mr. Roberts. Conversation on various topics. Moved and seconded to adjourn, lost. Conversation resumed. Moved and seconded to adjourn, lost. Discussion regarding Darwinism resumed. Move and seconded to adjourn, carried. Society adjourned."

Officers for the next term of six months were elected Jan. 7, 1876: President, Mr. Herrick; Vicepresident, Mr. Williams; Secretary, Mr. Lum; Treasurer, Mr. Scott. Successive parts of the "Inaugural Address" of the newly elected president were read at meetings of Feb. 4, Feb. 11, and May 12. Mr. Herrick was reelected for a term of six months, July 1, 1876. The following is the complete record of the meeting of Feb. 11, 1876:

"Society called to order by the Pres. Roll call. Minutes of last meeting read and approved. Parts assigned. Literary exercises. Reading

by Mr. Williams. sub. Vinegar Plant. Reading by Mr. Lum Sub. "America the Old World." Reading by Mr. Roberts sub. "The Rattlesnake." Moved and seconded that a committee be appointed to confer with Mr. Gillespie and see if the members of the society could visit the Government Works. Carried. Messrs. Clough and Roberts appointed. Moved and seconded that a committee be appointed to confer with Mr. Ham and exhort him to be more regular in his attendance. Carried. Messrs. Scott and Williams appointed. Moved and seconded that those who were absent Jan. 28th be excused. Carried. General discussion. Presidents Inaugural contin. Moved and seconded to adjourn. Carried. —Leon Lum. Sec."

At the next following meeting, of Feb. 18, we read: "Report of committee appointed to call upon Mr. Ham called for. The committee reported that Mr. Ham gave as his reason for not coming that there were only 168 hours in the week so he had no time to come and if the society could make any more he would be happy to come. General discussion." Apparently the discussion did not yield a satisfactory resolution of Mr. Ham's problem, for his name does not appear in the minutes of any subsequent meetings.

The "Government Works" mentioned in the minutes of February 11, 1876, were of lively interest as the final chapter of a thrilling history of desperate struggle to save St. Anthony Falls from sudden and total destruction. This would mean the loss of the waterpower and the ruin of the city's chief industries.

St. Anthony Falls were discovered and named by Louis Hennepin in July, 1680. The next white man to publish a report of a visit was Jonathan Carver in 1766. Following the Louisiana Purchase (1804), President Jefferson in 1805 sent Lt. Zebulon Pike to explore this region, and in 1819 a detail of soldiers established Fort Snelling at the mouth of the Minnesota River seven miles below the Falls. Shortly thereafter a government sawmill was built at St. Anthony Falls.

When the first commercial use of this waterpower was made in 1847*this cataract was near the end of its natural life. The caprock, about 12 feet of hard Trenton limestone, overlies a soft St. Peter

sandstone which was undercut by the falling water. The thin cap extends but 12,000 feet above the present brink of the Falls and in the natural course of the rapid recession of the Falls the caprock would surely have been worn completely away within at most a few centuries, for recession by normal erosion was 375 feet between 1860 and 1869. This would immediately transform the vertical falls into rapids of moderate slope.

The process of stripping off the caprock was tragically accelerated when a six-foot tunnel was driven for a millrace through the soft St. Peter rock from Hennepin Island below the Falls to Nicollet Island above. Excavation began at the lower end in September, 1868, and on October 4, 1869, it reached the lower end of Nicollet Island above the brink of the Falls. Now a rift through the Trenton caprock appeared above the Falls and the tunnel was flooded. A big whirlpool appeared at the rift and only heroic measures could prevent the rapid stripping of the remaining caprock.

My father told me when I was a child of that hectic morning when the alarm was given by all fire whistles and church bells. It was a Sunday, I believe, and probably the church of which he was pastor had few able-bodied men in the audience, for all available men and teams were requisitioned to dump brush, hay and stones into the vortex. These measures failed. A cofferdam was then built around the crevasse, which temporarily checked the flow. The necessary \$10,000.00 was raised by subscription and the work was finished on October 20. New breaks appeared repeatedly thereafter and in May, 1870, an engineer was employed who drew specifications for an apron of timber and masonry, which was built. But none of these devices were adequate and experiments continued for several years. The

federal government finally came to the rescue, building a supporting dyke 2,000 feet long and 40 feet deep under the caprock. This was completed in November, 1876, and still holds the Falls where the millers want them. Of the cost, \$545,000 was appropriated by Congress and \$334,500 by the city. This was a good showing for a city whose population in 1872 was only 18,316 people.

The "Government Works" at the Falls were nearing completion when the Young Naturalists began negotiations with the engineer in charge. The minutes of February 25, 1876, report that their request for opportunity to inspect the works was granted, and Dr. Roberts tells me that under the guidance of Mr. Gillespie they spent an afternoon examining the masonry underlying the "apron" covering the Falls. The writer of these notes on a recent visit to the Hoover Dam in Boulder Canyon was taken down through the elevators and the tunnels into the bowels of that vast mountain of concrete. The inside view of this triumph of modern engineering was a great event in my life; and yet I doubt if this thrill of the septuagenarian could rise to the level which these 'teen-year old boys experienced in 1876.

At the meeting of Sept. 11, 1876, Mr. Griswold read a paper on "The Sun" and "Mr. Herrick gave notice of an amendment to the constitution at the next meeting. . . . Mr. Griswold moved that the 'Farmer's Union' be adopted as the 'Organ' of the society. Considerable talk on this motion resulted in nothing definite." Mr. Herrick read a paper on "The Trenton Limestone." An abstract of this, as already mentioned, was published in *The American Naturalist* for April, 1877. On Oct. 2, 1876, it was "moved and seconded that the secretary be required to keep a list of the pamphlets, &c, which have been or may be presented to the society and act as librarian. Carried."

On Oct. 9 there was no quorum. In the minutes of the following meeting, Oct. 16, we read: "Names of birds handed in by Mr. Roberts. Names of corals also handed in by Mr. Herrick. General discussion. The operation of chloroforming a snowy owl to produce death

was successfully performed by Mr. Roberts in the presence of the members of the society. Moved and seconded that the society adjourn. Carried. — Leon E. Lum, Sec."

At the semiannual meeting, Jan. 8, 1877, reports were received from the president, treasurer and chairmen of the following committees: Ornithology, T. S. Roberts; Entomology, C. L. Herrick; Botany, R. S. Williams; Conchology, F. P. Clough. On Jan. 29, "Mr. L. E. Lum read an interesting paper on Physics the same being his report on this subject as chairman of the committee." These five reports and the report of F. S. Griswold of the committee on Geology are now among the records of the Society and will receive further notice in another article. On Feb. 12, a paleontological list was handed in by Mr. Herrick. At the meeting of March 5 there was an "address by Mr. Herrick" on evolution, especially as exhibited in bird lice.

In the minutes of subsequent sessions we find the following items. April 9, 1877. "Moved and seconded that the society extend a vote of thanks to Mr. Herrick for identifying and labeling the mineralogical specimens in the collection. Carried." April 23, 1877. "Reading by Mr. Griswold, Subject. 'Blowpipe Analysis, Directions for,' followed by general and informal practice with Blowpipes kindly obtained for the occasion by Messrs. Herrick and Griswold, together with material upon which to experiment." May 7, 1877. "Some unimportant experiments by Mr. Roberts illustrating the Effects of Ammonia Gas upon the colors of flowers. General discussion. Moved and seconded to adjourn. Carried. — T. S. Roberts, Sec. pro. tem."

June 4, 1877. "Reading by Mr. Williams. Subject. 'The Dodo.' Reading by Mr. Lum. Subject 'Phlogiston.' Business called for. Moved and seconded that the society find out whether a botany of the Northwestern flora has been published and if so to purchase it. Carried." June 18, 1877. "Paper by Mr. Herrick on the Embriology of the Common Hen written from personal observations. General Discussion." July 2, 1877. "Address by Mr. Herrick on the position of the old bed of the Mississippi River as shown by the geological

survey of the county and how from data obtained during the survey an approximation of the date of the glacial epoch has been arrived at."* Jan. 28, 1878. "Mr. Herrick gave the society a short account of his trip to the southwestern part of the State recounting some of the peculiarities in geological formation and some of the birds and plants observed and collected." On June 3, Mr. Roberts presented a narrative of a collecting trip, and on Aug. 26 and Sept. 28, 1878, Mr. Benedict Juni reported "general scientific notes from L. Superior" and "some particulars concerning the natural history, geology, &c of the North Shore of Lake Superior, which were very interesting."

The officers elected on July 1, 1878, for the ensuing term were, President, Mr. Williams, Vicepresident, Mr. Roberts, Secretary, Mr. Herrick, Treasurer, Mr. Lum. At the expiration of this term the society seems also to have expired, probably because of scattering of the membership. The last entry in the minutes is of Nov. 18, 1878, as follows:

"Society called to order by the president. Roll call. Minutes of last meeting read and approved. Reading by C. L. Herrick—'Method in History of Life' (Prof. Winchell). Description and history of the Radiometer by T. S. Roberts. Discussion. Moved and seconded to adjourn. — C. L. Herrick, Sec."

In addition to these minutes, the other documents in the files of the society yield some instructive views of the workings of these young minds and of the stage of development of natural history then attained in their community. A digest of these papers and a sketch of the subsequent careers of the three leading members is in preparation.

* Professor Winchell's estimate of the time elapsed since the close of the last glacial epoch was 7,803 years. His account of the recession of the Falls from the mouth of the Minnesota River at Ft. Snelling, a distance of about eight miles, is in Vol. 2 of the Final Report of the Minnesota Survey, 1868.

SCIENCE AND THE PROBLEM OF HUMAN VALUES

Dr. JOHN M. FLETCHER

EMERITUS PROFESSOR OF PSYCHOLOGY, TULANE UNIVERSITY

SOME years ago a distinguished American scientist said in one of his textbooks:¹

We live in a world of values. We have material standards of comfort, and moral standards of conduct; and we eat, and drink, and dress, and house our families, and educate our children, and carry on our business life, with these standards more or less definitely before us. We approve good manners; we try to be honest; we should like to be cultivated. Everywhere and always our ordinary living implies this reference to values, to better and worse, desirable and undesirable, vulgar and refined. And that is the same thing as saying that our ordinary living is not scientific. It is not either unscientific, in the regular meaning of that word; it has nothing to do with science; it is non-scientific or extra-scientific. *For science deals, not with values but with facts.*

This is a most important declaration concerning the province and purpose of scientific inquiry. It is important because it is not merely the peculiar and personal point of view of the late Professor E. B. Titchener, but rather because it represents a concise statement of the consensus of opinion of scientists in general, even though few of them may have bothered to draw the distinction which he pointed out.

To say that while we live in a world of values, and that although the satisfactoriness of our existence depends upon our modes of adjustment to these values, science can do nothing for us in our endeavors to make such adjustments, is to disqualify science for dealing with matters that concern us most, and hence to discount the part which it can play in human affairs. Such a conclusion

¹ Titchener, E. B., "A Beginner's Psychology," Macmillan Co., N. Y., 1915.

naturally challenges one's interest in an era so predominantly scientific as this.

In former ages of the world's history this severe delimitation of the functions of science would not have created the dilemma which it obviously creates to-day. Throughout the Middle Ages and later the authority and competency of the normative disciplines, such as logic, ethics, and esthetics, to deal with all questions of value were not successfully challenged. To-day, however, the presuppositions, and the canons, or norms, upon which these ancient and honorable disciplines are grounded are being scrutinized and their authority challenged everywhere except possibly within the sphere of influence of the University of Chicago, where, it would seem, a return to these disciplines is being looked upon with favor. There are, of course, ecclesiastically fostered educational institutions which have never departed from their medieval heritage in these matters. These would naturally prefer that the traditional separation between fact and value be maintained.

However, as between a return to the conventions of medieval thought and a consideration of the possibility of extending the scope of scientific inquiry so as to include at least certain aspects of the tabooed question of value, I believe that it is more in harmony with the modern temper to adopt the latter alternative. At any rate there seem to be sound reasons for holding that psychology, contrary to the dictum of the noted psychologist quoted at the outset, is one science which can not consistently waive

its responsibility for dealing with the problem of human values. In a peculiar way psychology must admit that it is human and that nothing which is human can be alien to its interests.

First, however, let us see if we can find any explanation for the fact that this question is to-day clamoring for attention with an insistence that is characteristic of our times. For an explanation of this fact one needs only to turn to the ideological struggles of the Old World, which have requisitioned all the resources of modern science for the destruction of those values which constitute what we are accustomed to think of as the substance of civilization. Here we see science, in total disregard of its responsibility for social values, prostituted to the ignoble task of aiding in the destruction of the very civilization it has helped to build. The mere *fact* that in doing so it is leading toward its own ultimate suicide should at least appeal to the curiosity of the scientific mind, however indifferent it may be to the *value* aspects of such an eventuality.

By waiving all responsibility for questions of value, science would step aside from most of the world-disturbing issues of our day, for these issues are issues of value, rather than of fact. Without doubt the most far-reaching and disturbing issue of our times, for example, had its origin in the Russian revolution. The issue there was clearly one of value, not of fact. The questions as to how many men own land in any country, and how much they own, are obviously questions of fact, and the answers to them are easily arrived at by methods of inquiry that are familiar to science. But the question as to whether it is a *good thing* for men to be permitted to own land at all is a question of value, and the answer to it, according to Professor Titchener, and according to the widely accepted tradition concerning the functions of science, lies completely out-

side the range of scientific inquiry, for "science," we are told, "deals, not with values but with facts." And so likewise with other vital issues of our times and our country, such issues, for example, as those of capitalism, socialism, labor-unionism, militarism, democracy, public ownership of utilities, competition versus cooperation, protective tariff, international trade agreements, ship subsidies, farm subsidies, race relations, and so on and on.

In all of these matters the really vital issue is, Which of the alternative policies would be for the best interest of society? The *facts* concerning these issues are accessible and hence do not necessarily lead to controversy. It is when we come to deal with the question of the relative merits, or values, of the alternative policies that we find the sources of disputes, conflicts, hostilities and war.

The dilemma with which modern society seems to be confronted might be stated as follows: Either we must conclude that our conception of the scope and methods of scientific inquiry can and should be readjusted and broadened so as to include in some measure these hitherto disregarded social problems, or else we must abandon the entire realm of values to the pure moralist, who seems these days to be fighting a losing battle, or else to the speculative philosopher with his normative disciplines, which hark back to the Middle Ages, disciplines whose influence on the lives of men grows less with time.

In recommending the adoption of the first of these alternatives one might also suggest the advisability of clarifying the distinction between "pure" science, so-called, and the "impure" variety commonly known as applied science. President Hutchins of the University of Chicago has brought this matter into the foreground of attention in current educational discussions. He thinks that the

invasion of applied science into higher education is one of the vulgarisms of our time, and is a main cause of the anti-intellectualism that characterizes our higher learning in America. Technology and vocationalism, in his opinion, have the effect of depriving universities of their only excuse for existence, which is to provide a haven, where, in cloistered seclusion from the madding crowd the "search for truth may go on unhampered by utility or pressure for results."

It has always seemed to the writer that, whereas it is well to maintain a distinction between pure science, or science motivated by intellectual curiosity, and applied science, or science motivated by interest in the practical results of discovery, this distinction becomes difficult at times to maintain. Such a distinction might be maintained between the rare genius and the common herd of mankind. Hence it goes without saying that it can not well be applied to the population in the average higher institution of learning. An investigator's interest in truth is not less affected by his interest in "results" if he happens to be concerned with the indirect instead of the direct consequences of his findings. A monograph, for example, on the theory of relativity, or on cosmic rays, may not yield cash dividends from industry, but such things do sometimes bring about promotions and other valuable considerations. Surely we could not say that the pure scientist is so unlike other human beings that he is influenced not at all by the practical results of his labors. There are, to be sure, martyrs in every field of human endeavor, but they are so few and far between in university halls that it hardly seems necessary to provide for them in the budget.

Furthermore, laying aside all traditions and theoretical considerations, it does not seem that the close alliance between the biological sciences and the practicalities of medicine has made them

less capable of "search for truth." Neither has the alliance between the physical sciences and industry, which has been so strengthened in recent years, lessened their capacity for scientific research. So far as one can see it has not even narrowed the scope of scientific inquiry, but has broadened it, as numerous research laboratories maintained by industry will testify.

The pure scientist has always maintained that one can never know what practical consequences will accrue even from the most theoretical sort of inquiry. And there are many instances in the history of science to support this contention. Now the applied scientist can, on the same principle, say that one can never know what results of great theoretical importance will accrue from pursuing, in a scientific way, questions of practical moment. The history of modern science especially can furnish many instances to support this contention.

The truth of the whole matter seems to be that where one's findings and conclusions bear upon and make important differences in human affairs, they are more likely to be checked and their errors pointed out, than they would be if they had no practical consequences at all. Such checkings, it goes without saying, makes for higher, rather than lower, standards of scientific inquiry. When a person permits an overwhelming interest in the results of his work to tempt him to draw hasty conclusions, such a person has simply failed to maintain proper standards of scientific procedure, an error to which theoretical as well as applied scientists are, and always have been, subject. The fault, then, in such cases lies not with the objectives, but with the methods of inquiry.

No more intensely practical problem could be imagined than that of social values. In our present state of confusion as to the jurisdiction of science in the case, and in the absence of other ade-

quate agencies for dealing with it, there is widespread fear that all our modern scientific achievements will but hasten the doom of civilization. It is therefore a distinct disservice for educational leaders to endeavor to heap contempt upon science for undertaking to deal with the serious practicalities of life, or to "humanize the utilities," as modern education is accused of treacherously attempting to do. Fortunately, most sciences are prepared to accept the opprobrium of this sort of treachery. They seem to prefer it to that of a pathological escape into the contemplative seclusion of the medieval cloister.

It seems high time to break up this ancient tradition of intellectual royalty and substitute a grouping of the sciences based upon the more democratic conception of the division of labor. The two main functions of science are explanation and control or application. In such a grouping explanatory science must always have a place of central importance. But explanation for the sake of explanation, or explanation as mental exercise, or mental discipline, can hardly be considered moral in an age so beset by life-and-death problems as is our own. The pedagogy of such a pursuit is also open to serious criticism.

Explanatory science deals with cause and effect relations, and has as its aim the establishment of facts and laws. Applied science or technology, on the other hand, deals with problems of means and ends, and should aim at the production of values. Mr. Aldous Huxley thinks that it is a mistake to separate problems of scientific techniques from those of social values in professional training. Besides teaching young men to be mechanics, for example, he thinks that we should teach them "to understand the ways in which machinery affects, has affected and is likely to affect, the lives of men and women." Certain it is that, in the absence of any feeling of responsi-

bility in such matters, the more highly specialized a professionally trained person is, the more of a menace to society he can turn out to be.

Technology should assume responsibility for two somewhat distinct problems. In the first place it should seek to ascertain what sort of means will produce what sort of ends. This problem is as simple and as clear-cut, and as factual as are the problems of cause and effect with which explanatory science undertakes to deal, and the methods of inquiry called for in the case are not different from those employed in theoretical science. In the second place technology, or applied science, must, if it is to carry out its part of a joint undertaking, devise ways and means of determining which ends are good and which are bad. This is the crux of our problem. Granted that this is a field of inquiry from which by common consent science has for the most part in the past been barred, does this settle the question? It is not a new event in the history of science to explore hitherto unexplored territory.

Can the knowledge and the technical skills of our time be brought to bear upon the confusions that characterize human relationships everywhere? Upon the answer to this question depends the unsettled issue concerning man's ability to govern himself, for, in spite of our miracles of discovery and achievement we have been accused of living in a Stone Age sociology.

Among the sciences which deal primarily with man anthropology, ethnology and archeology are essentially explanatory. Psychology is both an explanatory and an applied science. It therefore seems in order to examine its competency and its obligation to deal with certain aspects at least of this problem of social values. There are other aspects of this complicated problem with which other social sciences, especially

sociology, are competent to deal. These of course can not be considered here.

First let it be said that to a psychologist of the present day it seems strange to hear the claim made that man lives "in a world of values," but that the very science whose proper study is the study of mankind must consider him in complete disregard of this environing world. In accordance with the principle of relativity, which is recognized in psychology as well as in physics, man's environment is to be regarded as a function of his behavior. His actions are always directed toward some object or goal. His emotions have reference to certain situations and conditions, and his thoughts are always *about something*. To think of man otherwise is to make of him a pure abstraction. We are forced, therefore, to conclude that psychology, in the very nature of the case, must either assume the responsibility of taking cognizance of the value aspects of man's environment or else abandon its *raison d'être* as presently conceived.

Furthermore, what, may we ask, is the nature of that mysterious something called value that all science must avoid the consideration of it? In what realm of reality does it abide, so as to be forever beyond the scrutiny of the scientific mind? While there are many divergences of opinion among psychologists and philosophers who have attempted to answer this question by giving definitions of value, there seems to be an agreement among the majority of competent writers on the subject that it can be defined, as all other natural phenomena must be defined, in terms of human experience. That which is an object of *interest*, we are told, is by that fact recognized as having value. Likewise, things which have the capacity to provoke *desire* are by that fact invested with value. Value, in other words, is generally conceived in terms of categories of human experiences, such as *interest*,

appetence, desire, yearning, craving, etc., all of which are familiar to psychology and fall within the range of the inquiries which it has been prosecuting since it undertook to become a science.

Such a conception of value will at once be said to be subjective, and hence would preclude the possibility of generalizations in accordance with the requirements of science. "*De gustibus non est disputandum*," or every man according to his taste, are not good mottoes for science, so it will be insisted. Whether our feeling experiences are any more subjective than our perceptual experiences would be a question too intricate and involved to be considered in this connection, though to all except the naive realist the question is at least a valid one. The ideas we get of the physical objects before us are, we are told, derived from electrical discharges in the cells of our brains. The symbols or images which we construct to serve as the mental surrogates of these objects are, we are also told, no more like the reality of these objects than are the words we use to describe them. Hence the truth of Emerson's exclamation, "What a different world is walking about under your hat and mine!" He meant to say, I think, that what the world is to you or to anyone else depends more upon what is under the hat than it does upon what is out there.

And yet, the common ground of perceptual experiences, shared alike by all mankind, is sufficiently broad to furnish a foundation for all the vast accomplishments of the physical sciences. We have not as yet adequately surveyed the common ground of our affective experiences so as to afford a corresponding basis for the scientific study of the problem of human values. There does not seem to be any valid reason why such a study might not be prosecuted with this definite purpose in mind.

Since science does not pretend to be

competent to deal with ultimate reality it can not, of course, have anything to say about absolute good or absolute evil, granted that such values really exist. But in so far as we may think of good and evil hedonistically, that is, in terms of experienceable values, as all our authorities have defined values, then there seems to be good reason for assuming the competency of psychology to deal with them. The truth is that it has already made considerable progress in devising techniques for doing so, and has made some contributions in the application of these techniques.

Much of the work with these techniques has been done in the field of animal psychology. Some of the enthusiasts in this field are of the opinion that the essence of everything important concerning man's nature may ultimately be revealed through the continued analysis of the determiners of a rat's behavior in a choice point situation in a maze. Many others can not share this enthusiasm. It sounds too much like poetizing about the flower in the crannied wall. However, it is out of such simplified and controlled experimentation that we have been able to develop some of our most valuable procedures. The experimental attempts to measure social attitudes might be considered to admit of methodological refinements comparable with those which have been achieved by experimenting with rats in a maze. The pure scientist might, of course, resent the prostitution of his study of rats as rats to practical human ends, but fortunately not everyone can share his resentment.

If we define the socially good as being that which, in the long run, people, in the exercise of free choice, express a desire to perpetuate, we have a means of determining at least this sort of human value by scientifically satisfactory procedures, thanks to the rat in the maze. Voting, if it is to be a true expression of public preference, must, of course, be

free from constraints and from fear, and, if it is to be socially beneficial, must be exercised in the knowledge of the merits of the issues at stake. Voting pro or con, assuming such conditions to exist, would seem to give quite as valid evidence of satisfactoriness or unsatisfactoriness, liking or disliking, that is of values, as the corresponding techniques employed in the study of animal behavior. Democracy, let it be noted, is the only form of government which can meet these conditions of scientific procedure. Let the prophets of doom turn from their prophesying and urge the exploitation by the democracies of this crucial advantage.

✓ But the root of the difficulty of making politics scientific is not necessarily the impossibility of devising a scientifically dependable methodology, as has been indicated, but rather is it to be found in a veritable tangle of stubborn and stupid social traditions. We have come to accept the politician and all his ways as a sort of necessary evil. We are quite aware that the typical politician distrusts scientific knowledge, and has a holy horror of experimentation, which is the glory of scientific procedure. A defeated politician does not stop at *believing* his opponent's policies will not work; he proceeds at once to do all that he can to see to it that they shall not be permitted to work, and is honored as a faithful party man in doing so. Behavior that would put scientists in oblivion will put politicians in the seats of the mighty. Democracy, as a result of this tradition, remains on the level of the ancient trial by combat and will continue to do so until we adopt more scientific modes of evaluating public policies.

Picture a scientist sounding an alarm against a fellow scientist for suggesting new ways of doing old jobs. The typical politician, that is, the man who survives in office by the art of "playing politics,"

is almost a neophobic. To the typically scientific mind nothing is so welcome and stimulating as new modes of thought, new interpretations, new technical procedures. Mr. Charles Kettering, of the General Motors Corporation, is quoted as saying at the American Club in Paris in 1933 that "because we are unwilling to take change-making as part of our everyday life, changes are forced upon us and we say, 'this is catastrophic.' I do not believe that you will ever get civilization or government of any kind on a sound basis until you appoint a cabinet member on change-making, logical change-making, because you can not keep change from coming." The industrialists who view with alarm all departures from the policies of the founding fathers of business are quickly and automatically eliminated. Such people survive and thrive only in the field of politics.

Picture a scientist trying to convince people of the soundness of his theories by beating drums and blowing horns in their ears. Picture a scientist who would repudiate experimental procedure. Only politicians are permitted with impunity to do this sort of thing. It is one of the

inexplicable anomalies of our scientific era that we continue to subject ourselves to the leadership of those who, in the administration of public affairs, do such violence to the fundamental principles of scientific practice. Only the realization that this sort of policy is infinitely more dangerous to-day than it has ever been before can bring us to the grim determination to revolutionize our methods of dealing with problems of social values.

Once we accepted the rhythmic succession of economic prosperity and depression with a fatalism that was nothing less than primitive. Economists seem now—at least some of them do—to be persuaded that economic plagues, like other sorts of plague, are subject to human control. Our society is subject to another kind of rhythmic succession of good and evil, namely, the succession of rotten politics and reform movements. The possibility of dealing with this evil rhythm, which we continue to endure with the same primitive fatalism, is, in the writer's opinion, contingent upon the possibility of dealing scientifically with the problem of human values.

THE AMERICAN ACADEMY OF ARTS AND SCIENCES

By Dr. RALPH S. BATES

MASSACHUSETTS INSTITUTE OF TECHNOLOGY

In the recently issued pamphlet entitled "The American Academy of Arts and Sciences, 1780-1940" (Boston, 1941) the present writer was afforded an opportunity to review briefly the past accomplishments of the second oldest scientific society in America.

The Royal Society of London, from its formal organization in 1660, was the principal scientific body to which the American colonists turned, a number of

whom entered its membership or contributed papers to the *Transactions*. An attempt was made at Boston in 1683 to form a "Philosophical Society," and Cotton Mather, one of the prime movers in the enterprise, did creditable scientific work, which was later reported in Europe. When the young ex-Bostonian Benjamin Franklin sought to join a scientific society in Philadelphia and discovered that there was none, he organ-

ized his own, the "Junto," in 1727. Later, he issued his appeal for an American Philosophical Society in 1743 and laid the foundations for an organization of wider scope. By 1769 the remnants of these two bodies had coalesced and the merger resulted in a vigorous scientific career on the part of the American Philosophical Society in the closing decade of the eighteenth century.

Needless to say the successful enterprise was watched with much interest and almost envy by such civic-minded men of Massachusetts as John Adams and James Bowdoin, who soon dreamed of launching a similar enterprise in their own commonwealth. It was notably the experiences of John Adams, while in France representing his country in its struggle for independence, that started the chain of events leading directly to the formation of the American Academy of Arts and Sciences as he relates in his "Memoirs":

In France, among the academicians and other men of science and letters, I was frequently entertained with inquiries, concerning the Philosophical Society of Philadelphia, and with eulogiums of the wisdom of that institution, and encomiums on some publications in their transactions. These conversations suggested to me the idea of such an establishment at Boston, where I know there was as much love of science, and as many gentlemen who were capable of pursuing it, as in any other city of its size.

In 1779, I returned to Boston in the Frigate *La Sensible*, with the Chevalier de la Luzerne and M. Marbois. The Corporation of Harvard College gave a public dinner in honor of the French Ambassador and his suite, and did me the honor of an invitation to dine with them. At the table, in the Philosophy Chamber, I chanced to sit next to Dr. Cooper. I entertained him during the whole time we were together, with an account of Arnold's collections, the collections I had seen in Europe, the compliments I had heard in France upon the Philosophical Society at Philadelphia, and concluded with proposing that the future legislature of Massachusetts should institute an Academy of Arts and Sciences.

. . . I entreated him to propagate the idea and the plan, as far and as soon as his discretion would justify. The doctor accordingly did dif-

fuse the project so judiciously and effectually that the first legislature under the new constitution adopted and established it by law.¹

The fact that patriotism ran high as the Revolutionary War was being waged to a successful conclusion made it easier to plead that Americans ought to attempt to promote the arts and sciences in their own behalf by organizing a distinctively American academy. The efforts of the founders to acquire legal recognition by the Commonwealth resulted in "An Act to Incorporate and Establish a Society for the Cultivation and Promotion of Arts and Sciences." The charter thus granted on May 4, 1780, declared that:

As the Arts and Sciences are the foundation and support of agriculture, manufactures, and commerce; as they are necessary to the wealth, peace, independence, and happiness of a people; as they essentially promote the honor and dignity of the government which patronizes them; and as they are most effectually cultivated and diffused through a State by the forming and incorporating of men of genius and learning into public societies. For these beneficent purposes,

Be it therefore enacted by the Council and House of Representatives in General Court assembled, and by the authority of the same: That a list of the incorporators follows . . . are hereby formed into, constituted, and made a Body Politic and Corporate, by the name of THE AMERICAN ACADEMY OF ARTS AND SCIENCES. . . .

And it went on to state that:

. . . the end and design of the institution of the said Academy is, to promote and encourage the knowledge of the antiquities of *America*, and of the natural history of the country, and to determine the uses to which the various natural productions of the country may be applied; to promote and encourage medical discoveries, mathematical disquisitions, philosophical inquiries and experiments; astronomical, meteorological, and geographical observations, and improvements in agriculture, arts, manufactures, and commerce; and, in fine, to cultivate every art and science which may tend to advance the interest, honor, dignity, and happiness of a free, independent and virtuous people.

¹ John Adams, "Works" (C. F. Adams, editor, Boston, 1851-1856) IV, 260-261, in footnote.

Among those of the original incorporators that are remembered by posterity were Governor James Bowdoin, who became the first president of the academy, John Adams, Samuel Adams and John Hancock. By 1781, Benjamin Franklin, George Washington, Benjamin West, Ezra Stiles and John Warren had been elected into the society; in the following year Loammi Baldwin, David Rittenhouse and Jonathan Trumbull were among those taken into the fold. Thomas Jefferson was admitted in 1787, and Benjamin Rush in 1788. John Jay, Alexander Hamilton and James Madison were among the first men prominent in public life to be entered on the roster of the academy; while on the other hand, the names of the architect Charles Bulfinch and the painter John Singleton Copley evidence the wide range represented by the early membership of the academy.

Then, too, the rapidly expanding academy was becoming international in scope, for it could count among its esteemed foreign honorary members of the first decade d'Alembert, Lalande, Buffon, Euler, Priestley, Sir William Herschel, J. D. Cassini and that erstwhile American, Benjamin Thompson, then Count Rumford, residing in Bavaria, who became a member in 1789. His gift of what came to be later known as the Rumford fund was made in 1796. No award was made under it until 1839, when the chemist Robert Hare of Philadelphia became the first Rumford medalist in recognition of his invention of the oxyhydrogen blowpipe.

With the appearance of its first volume of "Memoirs" in 1785, the academy had meanwhile been launched on a career of publication. A preface to the initial volume, in addition to setting forth the aims of the society, contained a vigorous appeal to the "patriot-philosopher" to delve into the hitherto unexplored natural history of America. This same

stout volume contains no less than fifty-four papers, exhibiting interest in a wide variety of topics ranging from "Account of the Transit of Mercury, observed at Cambridge, November 12, 1782" by James Winthrop to "Observations on the Longevity of the Inhabitants of Ipswich and Hingham . . ." by the Reverend Edward Wiggelsworth.

The first research project sponsored by the academy was an astronomical expedition undertaken in 1780 in collaboration with Harvard College, to what is now Hlesboro, Maine, to observe a solar eclipse. Although the Revolutionary War was still in progress and the British naval blockade rigidly enforced, the scientific party headed by Professor Samuel Williams of Harvard was permitted to land. Insufficient time remained to the astronomers to determine a suitable site of observation, the weather was bad, maps inaccurate, and the upshot was that when the eclipse occurred the astronomers to their intense disappointment found themselves just outside the path of totality. Their disappointment might have been less keen had they realized that Professor Williams's report in Volume I of the "Memoirs" of the academy contains what is perhaps the earliest conclusive description and drawing of the phenomenon commonly described as Bailey's Beads.

During its first decade the academy had made solid progress, and a new chapter in its history came with the inauguration of John Adams as its president in 1791, a part which he was destined to hold for almost twenty-five years. In the early years of the nineteenth century men with intellectual interests as far apart as those of Nathaniel Bowditch and Noah Webster were contributing materials to the "Memoirs." A little later Loammi Baldwin, the ornithologist Thomas Nuttall, the botanist William S. Sullivant, the geologist

Edward Hitchcock, and the astronomer William C. Bond were among the leading men of science in the academy.

Meanwhile Horace Mann, Edward Everett, Jared Sparks, William Cullen Bryant, John Greenleaf Whittier, Ralph Waldo Emerson and Henry Wadsworth Longfellow were representative of those who strove to keep the humanities from being crowded out of an academy becoming ever more engrossed in the physical and biological sciences as such veritable intellectual giants as Louis Agassiz, Asa Gray, James Hall, Joseph Henry and Jeffries Wyman—academicians all—loomed on the horizon. Shy Maria Mitchell, of comet fame, was the first and only woman to become a member of the academy, being elected in 1848. In the same year the "Proceedings" were commenced.

By the closing decades of the century such scientists as James D. Dana, H. A. Newton, Simon Newcomb, George W. Hill, Edward C. Pickering, Josiah Willard Gibbs, T. U. Richards, Seth C. Chandler, Samuel P. Langley, Alexander Graham Bell, O. C. Marsh, Joseph Leidy, A. S. Packard, H. P. Bowditch and Charles W. Eliot had come into prominence in the academy which celebrated its centennial in 1880. Among the names of men in the academy eminent in the humanities and in the social sciences during those years one finds Centennial Poet Oliver Wendell Holmes, Charles Francis Adams, George Bancroft, Henry C. Lea, Lewis H. Morgan, W. G. Sumner, Francis A. Walker, B. L. Gildersleeve, H. E. Van Holst and

Henry Adams. There were also to be found men of public affairs and large philanthropies like Augustus Lowell.

A cursory glance at the roster of the academy reveals at once a notable galaxy of foreign men of science elected into membership during the course of the nineteenth century, including Humboldt, Thomas Young, Faraday, Arago, Maxwell, Lyell, Liebig, Darwin, Leverrier, Joule, Oersted, Clausius, Helmholtz, Kirchhoff and William Thomson. Among the more important foreign men of letters and affairs who became members in the nineteenth century were Guizot, John Stuart Mill, Thiers, Ruskin, Gladstone and Tennyson.

There figure in the annals of the academy during the early decades of the present century such names as those of A. A. Michelson, T. C. Chamberlin, Elihu Thomson, Percival Lowell, Alexander Agassiz, W. T. Sedgwick, Maxime Bocher and Charles P. Steinmetz. The academy, celebrating its one thousandth meeting in 1910 with a dinner typical of colonial times, heard Professor Edward C. Pickering forcefully reiterate the original aims of the academy when he sounded as his keynote that, "The real objects should be the increase and diffusion of knowledge, the first by research, the second by its publication."

In recent decades the academy has continued its career of fostering the growth and dissemination of the fruits of scholarship. In the present troubled world, the academy still stands as a beacon of the continuity of international learning.

AN ANTHROPOLOGIST IN RUSSIA. I.

By Dr. A. HRDLÍČKA

CURATOR OF PHYSICAL ANTHROPOLOGY, U. S. NATIONAL MUSEUM

Foreword. The writer has made three trips to Russia, in 1909, 1912 and 1939. He had chances to see large parts of the country, including Siberia and Mongolia, and the people of the same. He was everywhere aided generously by the Russians, and understanding their language had a valuable advantage. The notes that are to follow were made on the memorable trip of 1912, when in search of American affinities he was able to visit parts of southern Siberia and Outer Mongolia. They are the faithful simple records of a student of humankind and one fond of nature, for his wife who had to stay at home. By this day they are largely already but matters of history. Between 1912 and 1939 everything in Russia, Siberia and also Mongolia, has changed, was almost reborn or remade. What in the earlier years were but vast steppes or forests are to-day in many parts rich farms, with new and bright settlements; and what in 1912 were mere country towns were now found to be unrecognizable large industrial cities. Even the types of people, or at least their aspect and bearing, have changed, so that the whole population appears now rejuvenated and re-energized. It is truly a new Russia, new, virile and modern yet its own kind of a world—only the kindness and cordiality of the people remain as they were. And the same is true, from what was learned, about Mongolia.

In 1911, Colonel D. C. Collier and Dr. Edgar L. Hewett, the former in charge of the Panama-California Exposition that was to be held at San Diego, California, in 1915, and the latter director of the anthropological exhibits, approached me for a plan of an original exhibit in physical anthropology. There were consultations, the plan was submitted by me and accepted, and a sum of money was deposited with the Smithsonian Institution to be disbursed under my direction. The plan comprised the preparation of five halls of exhibits, the first devoted to man's evolution and antiquity; the second to his development from birth onwards or his life cycle; the third to man's racial and individual variation; the fourth to human decline,

pathology and elimination, and the fifth to anthropological library, instruments and methods. As no such a comprehensive exhibit had ever before been attempted and there was not enough of the needed materials at hand or even in existence, and in order that both the Smithsonian, under whose auspices the whole work was to proceed, and science in general might benefit as much as possible from the occasion, it was decided to send out a series of expeditions to Europe, Asia, Oceania, Peru, and to the St. Lawrence Island in the far northwest, between Asia and America. Two of these expeditions, that to Siberia and Mongolia, for a study of some of the peoples there and of their affinities with the American Indian, and that to Peru, for pathological materials, were reserved for myself and carried out in 1912 and 1913. Both proved highly fruitful as well as interesting, enriching the memory with whole lines of new experiences, some of which may be worth recording. The following are the day-by-day notes on the trip to Russia and Mongolia.

St. Petersburg, July 7, 1912. Over Europe since late in May. Attended a scientific congress in London, scoured France, Belgium, Germany, for needed specimens and preparations, and eventually reached Russia, where I am now impatiently waiting for necessary documents, and learning Russian. Have as yet no permission for Siberia and as matters look now will in all probability get none for Mongolia. Am bound nevertheless to go and try to do what I can with some friendly letters, permission or no permission, until they send me back; but if I have to go thus it will be far from pleasant. There still seems much resentment felt in this country

over the abrogation of the Russo-American treaty by the U. S. which was the work, they say here, of our Jews. Another anxiety are my boxes with instruments, etc., sent here from the Smithsonian. Have been unable thus far even with the help of our people to find if they are here. Have also sent here to the Embassy, through mail, some printed blanks from Paris, and find that they are held at the custom-house. Some of the people whom I have to see about the Far East are on vacations and I have to go after them into the country, even to Finland. And the language is difficult in the beginnings. So there are troubled waters enough. But I may yet find a way through it all; have gained one in-

will not be back till evening of the next day. Walk again—no car, no drozka about—and search for a restaurant for lunch but find none; with limbs weary reach finally the Museum of the Old Academy where I know two or three people, only to find that they also are out of town, for this is the period of vacations. But the one man who is there, an assistant, treats me to a glass of plain tea, at 2:30 p.m. Another good walk to a car and a trip to the principal Bibliothèque, where I understand my boxes from the Museum would most probably be. Meet the Secretary—and he tells me nothing has come. He has however a letter in which the Smithsonian informs him that the boxes were shipped the 31st of May,

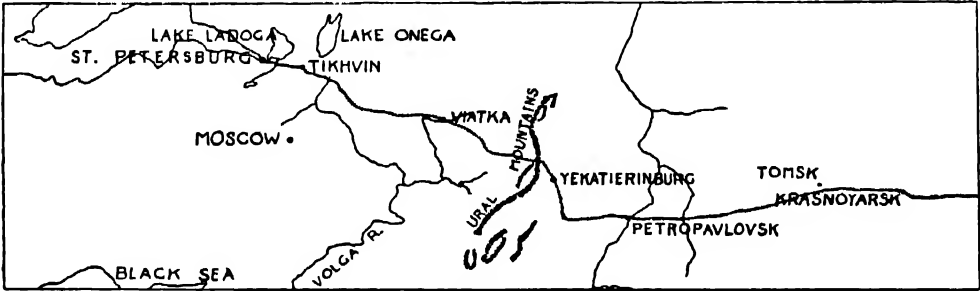

FIG. 1

fluential friend; and am healthy and vigorous.

July 10. This is how it went yesterday. 9 A.M.—coffee, restaurant half a mile distant, Polish; in the hotel here prices too high, of mornings everything smells yet of last night and life is barely commencing, and all service venal, after fees only. At 10 a visit to the Ministry of Foreign Affairs in search of one who could perhaps help with Mongolia—he will not be here till 11. Walk the streets. Come back at 11—not there yet. Go again and come back 11:30—still not there; go to his office, and there after some ten minutes am told that he will not come to-day. Get his house address and go to search him there. Walk an hour over the hard pavements and at last find the house—only to be told that the man I want has gone somewhere and

but when they will get here he knows not. Well, there is nothing to be done; if the boxes do not come before I leave, they will have to go back and I shall have to get along the best I can. They contain my photographic outfit, blankets, clothes, etc.; but I have a smaller camera with me. Swallow some lunch nearby and then to the Finnish station, for I must still reach Finland this afternoon. At 4:30 on train, at 6:15 at Raivoli, Finland, then 5 versts in an old cab, and I am with Professor Radloff, whom I know from before, director of the Ethnographic Museum and president of the Society for Exploration of Central and Eastern Asia. He is a highly esteemed old man and receives me very cordially. The girl brings a cup of coffee and some biscuits; we talk and talk. He will help me with letters to the authorities in

Siberia and Mongolia. Will make me, still better, an "agent" of the Imperial Geographic Society, which is an official body greatly respected everywhere in the East by all Russians. At 8:20 my *izvoschik* comes back for me. At 8:55 A.M. again on train for St. Petersburg; arrive 11 P.M., swallow three or four little bits of sandwiches at the station and a glass of hot tea, take a car, then another, and just before 12 A.M. back again where I started from this morning, in the Hotel de France and my little "chambre." Slept like a stone till quarter of 7, though dog-hungry. To-day at 11 the Ministry of Foreign Affairs again, just to try my reviving luck; then to the American Embassy; then the anthropologists at the Museum of Alexander III; and then the custom-house, if time permits, and after some information. But do not mind now anymore. . . .

July 13. 12:30 p.m. Wonders still take place and good fortune still can smile broadly, even in Czarist Russia. Am on the fast Siberian express leaving St. Petersburg, bound for Krasnoyarsk, central Siberia, where the train is to arrive six days hence. The Ministry papers, am assured, will go after me in a few days; have a pocket full of Russian letters of introduction; have engaged a nice young man, a University student, speaking English to meet me in Siberia and he will bring my boxes, which have at last come on a boat not yet unloaded. Besides all of which the sky is bright and the ground green, and I am beginning again to feel my old good-natured self. But I did not know until within twenty-five minutes of the departure of the train whether I should be able to leave. Will not mention all done and walked and waited since I last wrote, but now I am on the fastest and best train they have here. Only this—as a lesson. I saw the officials of the Ministry of Foreign Affairs at last, thanks to my influential new friend, Prince Ukhtomsky; and they very

kindly made us to understand that the delays in issuing my permissions were due to the fact that they had received from our Embassy a letter which they could not quite understand. This letter was written, I found later, by a young woman interpreter at the Embassy who was French and did not know good Russian. . . .

3:30 p.m. Just had a splendid lunch on the train, for 75 cents: fish with shrimps and mushrooms, meat with vegetables, and *čaj*, the hot, sweet Russian tea with a slice of lemon in it, with which the good moist black Russian bread and sweet butter. Am alone in a *coupé*—the porter, to insure a bigger fee, has already called my attention to it, saying that he has put the one who was to share with me into another compartment. All want fee here, as elsewhere in Europe, but they endeavor to earn it and are not rude about it. The more I learn to know them the more I like the Russians. . . .

Ride through extensive flat country—all is flat for great distances about St. Petersburg. Most of the ground is covered with young spruce and birch forests of different ages, with grassy patches between, unutilized, and far apart a "dierevna"—a small but mostly large drab log-house village with a round of fields and meadows about it, on which graze cattle with big heads and horns, and work women, girls and older men, piling up hay. Cross the Volkhov River, bigger than the Seine, but here no one takes any notice of it. There are barges with square sails which remind one somewhat of the Nile. Now and then pass a clean wooden station with the characteristic bearded grizzly Russian *moujik* faces. . . . Towards evening, pine, spruce, fir, birch forests, from saplings to half growth. Dead patches, after fire; cords of cut wood in the forest; rarely a human being—lone postman, a peasant, a girl—one wonders where they are from and why so far from

everything. A village of about ten frame or log houses with poor fields, and with hundreds of cords of cut wood. Smaller and larger streams, with more or less muddy water. Large sandy patches along the rails, sandy roads. Again great stacks of wood, the fragrance of burning branches. Here and there swamps. The bleak hand of the north visible. In the south such lands would soon be fit for cultivation, but here they stay just wastes.

Now the train runs on a raised bank, the forest is so low that one can see many miles away, and it is like in the pampas of Argentina, only all covered with small woods; not quite all, for there and again in another place is an agglomerate of a dark village, with a few red roofs, and in distance ahead the blue and golden cupolas of three Russian churches in Tikhvin, a little city. These blue, green, grey and gold cupolas and spires of the Russian "pravoslavny" churches look everywhere chaste and beautiful, but most so amidst the green scenery. They seem the embodiments of pure prayer, of higher solace to the human sufferer. . . .

Once in a while rural or forest worker with shirt worn belted over the trousers, or a woman or girl with a white kerchief on her head. White, yellow, reddish, bluish flowers scattered through the grass; an occasional field of rye or potatoes or cabbage. And all the rest the self-same pine, spruce and birch.

Alone in my spacious compartment, undisturbed, and so can give myself fully to the odd world through which the train is passing. The "express" goes thirty miles an hour, and about every forty minutes there is a comfortable stop, the men oil the journal boxes, passengers step out and stretch limbs, the locomotive gets an additional supply of wood, children bring milk in bottles and sell to passengers, the bell rings, conductor whistles, everybody leisurely gets in, then another signal, a hardly perceptible

start—and we merge deeper into northern Russia. I sit on a stepladder at the window and look and think and write, and feel happy as we go. A savory smell of supper comes through the spacious good cars, and again the smell of the woods and grasses. It is comfortably cool. What more for the while could one wish for. Some jackdaws—but strangely but few other birds; pools and ponds of water; and woods, woods, woods. . . .

8:30 p.m. Near sunset—days here are long. The red glowing celestial ball reposes a few moments on the tops of the low trees on the horizon. Supper—soup, fish, some kind of a game bird, little ice cream, and two glasses of golden tea with lemon (they serve nothing in cups unless demanded)—88 cents; and plenty of everything. No stinting on trains in Russia. An accident during supper—in passing one of the poor little villages some ignorant threw a stone and broke one of the windows of the dining car.

Pass two saw-mills. How homelike it must be for wolves in these endless low forests. And what a life it must be in those isolated villages, especially those far away from the railroad, alone in the vast green wilderness. Who could show such a life, truly and entirely—or has man even here conquered nature? The beds made, the long northern twilight is upon us and slowly deepens. . . .

July 14. Sunday. Bright peaceful morning, as if Sunday reigned everywhere. Had a nice clean bed, but it was cold and I wished I had my camel-hair blanket! Had to help with the coat.

The road is sandy, dusty, and everything got greyish over night, but the porter, who speaks Russian so clearly that I understand him readily, has made everything near neat again. Outside the scenery still much the same as yesterday, only more water, brown or rusty but clear, and the forests more spruce, more undergrowth, more dense. The villages the same but even farther apart, twenty,

thirty miles in cases. Some horses graze on a meadow, the Russian horse, with body medium or smaller as compared with ours, but a good-sized well-formed head and thick mane. They are generally red or brown in color and appear full of power. Little girls bring wild strawberries to the train, ten kopeks (5 cents) a full plate, but no paper, which probably in these small settlements is a very scarce article. Another good-sized river, the Sharia. A few birds. Plenty of grass going to waste—few people, few cattle—still too northerly.

The forest, for a wonder, this forenoon gives away! At first segregates in large patches and at last its remnants are only like scattered larger and smaller islands. The country is now uneven and covered with fields, but these still of mediocre quality. Windmills appear, wooden, uncouth, home-made like. A village or two are passed close and it is seen that the gable-shaped roofs are made of boards running not from side to side but from above downwards. There is no paint on the log-houses or roofs and everything, unless new, has the dull slaty color of old wood. Some goats and sheep are seen for the first time. The sky is getting cloudy, and it is as cold as with us about the middle of October, one could easily bear heavier clothing. Peasants are seen with peculiar open-work felt sandals, the "laptie"; some look as if made from straw, and are worn over a cloth wound about the feet and legs, which reminds one of the leggings of our Pueblo Indians. A boy stands at a little station barefooted and with his boots hanging over his arms—not a rare picture; the boots are expensive while the skin grows. . . .

As we near *Viatka* (now Kirov) a change in houses and other constructions becomes manifest, the roofs now slope in four directions instead of but two. The dwellings also are more square. There are large A-shaped sheds, for hay prob-

ably; and occasionally one sees half underground dwellings covered with earth, as we used to have in the Dakotas. The hand of the north.

Viatka is a sparse city with a cathedral of five cupolas, beautifully dark blue. At the station they sell all sorts of hand-made wooden things, especially nice plates with carved mottoe inscriptions, and Siberian gems. But the common people are disappointing. They are not of the good Slavonic type. They speak Russian and have doubtless some Russian blood, but are most likely largely of Finno-Ugrian admixture. There are seen often rather long faces with prominent cheek bones, mouth, and angles of the jaw, and with various shades of grizzly or pale hair and beard. And many look uncultured. They are, of course, the untutored peasants, but they are not like the peasants of Bohemia, Moravia, Poland, or more southern parts of Russia. The women look better though nothing to boast of. A true open Slavic physiognomy makes here and there a pleasing exception. . . .

Another good-sized river, the *Viatka*, after the town. More fields, but then again poorer country. . . . At 3 P.M. again all a young forest, except now and then a smaller or bigger clear patch.

8:30 p.m. No day passes without some returns, and so with this. Most of it was rather dull, with chilly, cold, overcast sky, poor scenery and uninteresting people, until near supper. Then the country became one mainly of fields and villages, and the people changed for the better, different, more intelligent, more lively. In all probability another strain, more Russian. But the fields are still not rich and we are evidently nearing still worse or a more unfortunate region, for as we stop at a station during supper Russian young men and women, probably University students, come in to ask aid for the hungry who through drought had no harvest last summer. And they pin to the coat of each one who contrib-

utes, and there are none who do not, a little bunch of green rye-tops, the harbingers of a better summer and winter this year. Here they are—I shall save them. Gave not much but gladly, and there is inside already a warm nook for these people. The masses are backward, but they only need awakening, as shown in every eye, every fiber of these youngsters. The girls in particular, they are not beautiful yet attractive, intelligent and refreshingly free from flimsiness either in dress or behavior. . . .

July 15. Monday, 6:30 a.m. Sun, bright morning; but at 7:30 cloudy again, and now rainy, cold. The country has changed again, there are now low hills and shallow basins—approaching the Urals. The ground too is more fertile. There are many fields, with cattle, geese; and there are numerous smaller villages. Bits of the forest remain, but cultivated ground predominates all over.

9:30 a.m. Slowly going higher—this train is surely no “speeder” in our sense of the term—we have made, I learn, on the average less than twenty-five and now are running about fifteen miles an hour. But it is all very comfortable and gives a good chance for observation. The hills are low, underlaid with horizontally stratified shale as near Pittsburgh, and it would seem natural to see coal mines and oil-pumps, but none are visible. The houses and villages are much like those before, with occasionally a red or green tin roof. The people preserve the better type, more Slavonic; and there is about them something interested, sympathetic and friendly, which one misses in other countries. If only it were warmer. What must it be here in winter!

10 a.m. Once more forest only, on all sides. . . .

5 p.m. Hard to write, so chilly. The thermometer shows 57° F., but the damp air makes it feel much lower; and the train can not be heated, they say, at this time of the year. They promise better once we get to Siberia.

Forests, or rather one vast forest, again since this morning, with only patches of clearing, sometimes far apart, and even there the young trees are sprouting in many spots wanting to retake what was their own. There was, however, a large town, Yekaterinburg (now Sverdloosk)—like an oasis.

Nevertheless the scenery is much nicer than yesterday, and in sunlight must in its way be beautiful. Now, towards the evening, the train runs through peaty levels which are overgrown by the trees more sparsely, often in bunches, with the higher parts of the ground among them covered with low grass interspersed with daisies and other little flowers—the whole looking like a fine natural park. But thick woods commence at the low hills behind; and a boy tells us the wolves come to the little settlements here every night, after sheep. Little more north bears come, also. This must be the country of which some of the older European folk speak “where the wolves give good night and the bears good morning.” . . .

Not a fruit tree of any kind, not a dozen seen since St. Petersburg—can not stand the winters here; and though this is the midst of July twice already have I noticed the leaves of some garden plants wilted by frost. Yet it must be beautiful here in fine weather, and the people look sturdy, animated, good. . . .

At Yekaterinburg saw a mass of emigrants for Siberia. All poor, often in big worn leather coats, big caps and big boots, or with the legs wound in rags; but many of good physique, sturdy, and none dejected—surely good materials for the peopling of the wilds of Northern Asia.

In the villages it is a common thing, notwithstanding the chill and drizzle, to see a child running barefoot. No one outside in fact seems to feel the cold as we do here in the train.

See some women, and again others, in short skirts, high boots, a whitish kerchief on their head, and each with a scythe on her shoulder. Their backs are

somewhat bent from work, but they walk easy and surely do not look "downtrodden," or anemic, a good strong stock.

Pass a village of many hundreds of houses, the largest yet seen; but the houses are all alike and the dark dull color of the old wood, now wet, under the leaden sky and with the muddy roads, look gloomy. A church with its fine blue cupolas in the midst is like a fairy palace in comparison. But the view is lost in the forest before one can wholly consider the scene. The ever present daisy, quite the same as ours, is always with us, and so is the fireweed, which has spread over much of the northern parts of the globe.

6 p.m. See to our left for the first time what deserves the name of hills, but not great, not much more than those about Washington. If the Ural here is thus then it does not deserve the name of a "mountain" range. But where all is flat even a small hill becomes a "mountain," and there are parts where the range is much higher.

A little while yet and we will be in Asia. The notes for this day will already be finished in Siberia, the vast, concern-full, wonderful, unknown, the motherland of our Indian and Eskimo.

Sorry for all this fine grass hereabout that is going to waste; there must be tens of thousands of acres of it here, for it extends even into the woods. What flocks could graze here—and doubtless will in the future. . . .

A little station, children bring blueberries, and a young man a live porcupine. There is no insistent or unpleasant tone to the offerings, the prices are moderate, and sellers as well as buyers good-natured.

July 16. Tuesday, 9 a.m. Southwest Siberia, Asia! And one would only need to half close the eyes, so that the low young birch woods here and there looked more like cottonwoods, and one might be somewhere on the prairies in western Nebraska or Kansas. There is the same

dark earth, the same drying grass, and here and there even a little patch of alkali. Much here already cultivated, and with only more moisture this would be a rich country. Once in a while a large shallow pond or lake—exactly again as in some parts of the Mexican plains. Nature repeats itself. Nor are the grazing cattle and horses missing, or even the distances, or straggling new settlements—only the dwellings are different, more log-houses, more sod on the roofs, less board; but the differences are not very material.

The air is warmer and the sky, though cloudy, shows patches of bluish. The wild vegetation has changed, too, as if by a magic. There is no more clover, no more fireweed here, nor even a daisy; instead what looks like a caraway-seed plant and yellow, white, pink and blue wild flowers, some of which I do not recognize. . . . Have passed a short time ago Petropavlovsk, a rather large town, lying at a tributary of the great Ob River.

P.M. The country changes but little, except that cultivation is becoming much less. On both sides there are now endless grass-covered steppes over which appear like sparsely sown smaller or larger patches of young birches. On the grassy levels between are seen now a herd of cattle, now stacks of hay, and then again nothing but wastes, with far away level roads showing the deep dark soil. Once in a while one, two, three men or boys on horses, or the characteristic small-wheeled Russian troika, or a woman turning some hay so it will dry better. The wild parsley has increased until now the levels are yellow with its flowers, like those of fennel.

Before Petropavlovsk saw the first Kirghiz or Tartars, dusky, mongoloid, but apparently quite sturdy people. Saw also two of their round tents. One of the men could easily have been an American Indian.

In places along the tracks piled-up

sections of snow fences, ready for winter—as in our Rockies. Patches of ground that show drought, but also small swamps or pools. At times the birch thickets recede to the very horizon and there appear raised above the ground in half haze, like a mirage—exactly as distant bushes on our prairies or brush along distant low banks along our rivers. Then again a region where the thickets occupy almost the whole vista—and then once more great worked fields, with thousands of hay-stacks, or long lanes of wheat or barley. On the other side a large shallow pond with a herd of cattle reposing close to it, like on a Dutch picture. An ideal country for grain raising and cattle and horses—until one doubts that this can be Siberia.

Pass a freight train, flat cars, on them some men, and a woman with bags—evidently the state does not mind if some one thus gets a cheap ride. Pass trains full of peasants, the migrants. Crowded in converted freight cars with small windows near the roof, sleeping on tiers of shelves. But their welfare appears to be looked after—one sees everywhere samovars in the cars and at every larger station there are for them free hot water and cheap provisions.

The Russians call the dead body a "pokoinik," the peaceful one; "nediele" (no-work), originally Sunday, is now a week; "golubčik," and "golubuška"—he- or she-love; and a wild flower is a "dikói cvietóček." The whole language is soft and, when well spoken, very pleasing. I spend all my spare time learning and reading it, and light is coming. Like the language more and more and hope to acquire at least as much of it as I need in travel and work. There is not a foreigner on the train, except two Japanese, and they speak some Russian, so I can not but hear and learn. Only like everywhere there are but very few who have the fairies' gift of speaking with clearness and purity.

First little sage-brush—we must surely now be at the edge of our prairies. A girl in a pool, red skirt tucked in above knees, washing linen. Black sheep. Sod-covered low dwellings. A little station—women bring half-ripe looking, but sweet, small wild strawberries—use them also for preserves; have big buckets full, must be very plentiful. . . .

More Kirghizes—of brownish skin, peculiar round caps on heads—are Mohammedans—and peculiar shoes. Look at stations for a postal card that would be showing some of them, but in vain. As with us the last thing of interest to the vendors are strangely the local and especially the native people. . . .

Have made two friends on the train already, one a young Russian officer, the other a Russian engineer. The latter goes out with me at Krasnoyarsk, which will be already the morning after tomorrow. How "small" is Siberia—have barely begun to be acquainted with it and already off the day after to-morrow.

17th, Noon. A whole little village with sod-covered roofs; also half-underground sod-roofed houses with little windows. Saw once very similar things in South Dakota. Not Russian. . . .

The scenery keeps similar; yet since Nicolaievsk there comes a change, unevenness in ground, low ridges on horizons, birches higher, ground well covered with grass, and fields of grains. The earth itself is the same blackish earth as everywhere thus far in southwest Siberia, old loess, humus and alluvium. No stone in sight anywhere, and future architecture will be brick only. The black ground like ours in Illinois, and those grand rivers that can easily be utilized for irrigation—what a future; and what a future after the children of all these sturdy immigrants, brought up under these vast free skies, acquire education. There will surely then be a new Russia, a new great people, a New World in Asia.

(To be continued in April issue)

BOOKS ON SCIENCE FOR LAYMEN

MATHEMATICS FOR THE PHILOSOPHER

Mathematical Logic. Willard Van Orman Quine. xiii + 848 pp. \$4.00. September, 1940. W. W. Norton and Company, Inc.

PROFESSOR QUINE'S book is far too technical for adequate notice here, and we must refer to the mathematical abstract journals for fairly detailed notices. The complicated printing and proofreading have been done with extraordinary care (page by page use with a small class disclosed surprisingly few slips, either of statement or of printing).

The impression a detailed reading made on at least one mathematician may have been shared by others. In spite of all its formulas, and the great skill shown in constructing proofs, the book is that of a philosopher rather than a mathematician. A class in philosophy would find here endless opportunities for metaphysical polemics. A class in mathematics, on finishing the book, might feel somewhat dazed, as if they had been present at the creation of a new heaven and a new earth: "God said 'Let there be an infinite set of so-called *axioms of quantification.*' And there was an infinite set of so-called axioms of quantification." It is not quite as simple as that, of course; the infinite set is merely 'specified' as a device to aid calculation. Mathematicians have long been addicted to specification. Without it, a large part of extremely useful mathematics might never have come into existence.

To the reviewer the most interesting part of the book was the concluding chapter, "Syntax." Here the author expounds his own derivation of Gödel's classic theorem on the incompleteness of logic and arithmetic. It is not easy reading, and possibly it is one of those really deep things in mathematics that

have to simmer a long time before they either boil down to a fairly stable solid residue or evaporate. One of the conclusions may be stated:

"Indeed, a notion of theorem capable of exhausting those logical formulae which are true and excluding those which are false will be definable only in a medium so rich and complex as not to admit of a model anywhere in the reaches of logic and the derivative body of mathematics."

For those who are willing to master a symbolism essentially simpler than that in more technical mathematics, the book can be recommended as a stimulating account of some of the main topics in mathematical logic. Much of the presentation has been influenced by the author's own work. This is nothing against it. What is the point in bringing out books which follow their predecessors like sheep going through a hole in a fence?

NOTE: Since the above notice was written, J. B. Rosser (*Bulletin of the American Mathematical Society*, 48, 1942, 21) has pointed out that "Unfortunately, the system of logic presented in this book admits the Burali-Forti paradox. This admission renders the system inconsistent. As a result the book fails in its primary purpose and will need serious revision." The first three chapters and (except for minor details) the last are unaffected by the paradox.

E. T. BELL

THE PHYSICAL SCIENCES AND THEIR APPLICATIONS

Science in a Changing World. Emmett James Cable, Robert Ward Getchell and William Henry Kadesch. xvii + 665 pp. \$3.75. 1940. Prentice-Hall, Inc.

For the rapidly increasing number of adults who have developed a real interest in the physical sciences or in their applications and who wish to achieve a degree

of correlated understanding this survey of the elements of physics, chemistry, geology, physical geography and astronomy should be of real value. It is mature, very readable, well illustrated, sound and thorough without being technical. It is practical in the sense that every topic begins with common, well-known phenomena and then explores the reasons and explanations. Thus, without ever being didactic or deparmentalized, it engages the reader and gives him a better knowledge of the fundamentals of these various sciences than most college students would retain from a number of separate and more technical courses.

The authors are professors of geology, chemistry and physics, respectively, at the Iowa State Teachers Collegé at Cedar Falls and have perhaps developed this book from a unified course in the physical sciences for education students. It would serve such a purpose very well. Surely every teacher in the elementary schools needs at least this much understanding of the world about us, though it is equally sure that few now have it. College professors in the separate sciences will object that such a survey does not go far enough nor deep enough, but the limitations on such a course are rigorous and only one who has attempted to make such a selection can commend the authors for the scope and level achieved. True economy of college time consists in learning only what will not be forgotten and from that point of view this book should be a success.

The reviewer must, however, object to the catch-penny title—and on two counts. The word "science" covers a far broader scope than does this book. It is unethical, and should be reprehensible, to offer in the title more than is covered in the book. One could as well give the title "Medicine" to an elementary book on anatomy, or "The Human Drama" to a version

of Shakespeare. And, secondly, the changing world is not once mentioned in the text. There is a five-page final chapter which looks ahead a bit to what may be expected of applied science in the years to come, but nowhere is there a discussion of social and economic conditions as affected by science or as undergoing any change. That would be an entirely different sort of book. It is, of course, usually the publisher, not the author, who selects the title, and this lack of candor and precise expression can certainly not be charged to the very competent scientists and teachers who are the authors.

GERALD WENDT

A PSYCHIATRIC ANALYSIS OF KING GEORGE III

America's Last King. Manfred S. Guttmacher. Illustrated. xv + 426 pp. \$3.50. 1941. Charles Scribner's Sons.

THE current general interest in biography is evident to every one who reads the advertisements; the proportion of biographies to the total output of new books is greater than for many years. The reader should not gather the impression, however, that the instant volume is "just another" biography.

Here we have a highly readable account of the life and times of a man who reigned in England for sixty years, during a period which saw the American Revolution, the French Revolution, the rise and fall of Napoleon; a man who suffered during his life five well-documented attacks of manic-depressive psychosis at a time when much less was known of the care of the mentally ill than to-day and when public attitudes toward mental disorder were considerably less enlightened. This picture, of political, historical, psychiatric and human interest, is portrayed by a prominent psychiatrist who has for many years pursued a study of George III, much of it

from original and hitherto unpublished sources, and who combines with a deep psychiatric insight and a solid knowledge of his subject a skill in writing which is lamentably scarce among medical men, and indeed none too common anywhere.

One feels a sympathy for poor George III, a neurotic young man, of limited capacities, dominated by his mother and possessed of none too favorable a heredity, called upon to head an empire at a time when the whole world was in flux; conscientious and inherently decent (buying votes in Parliament was *de rigueur* in those days!), taking his task too seriously and exhibiting a pathological stubbornness as a defense against his own inner insecurity; troubled by parliamentary disputes and by the highly unfilial and unconventional conduct of his children, a much harried man who found his only escape a psychosis. As Dr. Guttmacher sums him up (p. 259):

So conscientious and honest an individual was George III that he could not, when well, comfortably dodge reality. He had none of that facility for postponing and evading issues that more unprincipled men possess. He hated euphemism. He could not tolerate solving problems by pettifoggery or what he termed "metaphysical reasoning." Whenever the necessity developed of compromising with what he considered absolute truth, he suffered painfully. Men of this type in public office are constantly tormented and harassed; only opportunists are really happy in politics.

This rigid, scrupulous psychological constitution was chiefly responsible for George's attacks of mental disorder. Had he been able to delegate unpleasant tasks to his subordinates, leave difficult decisions for others to make, or adopt a "come what come may" attitude and do the best he could with a problem, he would not have become insane.

The book can be heartily recommended as a valuable addition to psychiatric and biographical literature, to be read with profit and pleasure by the physician, the historian and the general reader who is interested in the stuff that human relations are made of.

WINFRED OVERHOLSER

ALLERGY—ITS NATURE AND TREATMENT

Strange Malady. Warren T. Vaughan. Illustrated. xvii + 268 pages. \$3.00. 1941. Doubleday, Doran and Company, Inc.

"STRANGE MALADY," as the title implies, suggests that the reader is about to encounter a discussion of one of the human ailments concerning which little is known. However, after perusing the two hundred and fifty-five pages of Dr. Vaughan's book, the layman will come to the conclusion that great progress has been made by scientists, both in Europe and in America during the past twenty years, toward the solution of these strange allergic manifestations. It is to allergy that Dr. Vaughan has given his appropriate title.

The book is divided into five parts. The history of allergy should be of special interest, as Dr. Vaughan has had the opportunity, because of his distinguished father's associations, to meet at first hand in his own youth a number of the early students of this specialty, and to acquire from his father intimate details and anecdotes of the work and habits of these scientific men.

In part two the discussion of allergy and the relation of one manifestation to another is linked together in such a concise style that the reader might assume after all the problem is quite simple, and that the solution of the mystery depends only on a careful study of the patient's environment and the history of events in the progress of the disease. This assumption might be correct in a limited number of the victims; the history is most important. But often the patient still "lives" a miserable existence in spite of most careful investigation; and to this sick individual Dr. Vaughan's title can be aptly applied.

The author touches briefly on the treatment of allergy in part three. He de-

votes only fourteen pages to this phase of his publication. He must have given careful thought to his final decision to limit this discussion to the barest details. Only confusion would have resulted had he attempted to present the many procedures with which the allergist attempts to relieve his patient.

Part four begins with the statement that "Sensitization to foods is the commonest form of human allergy." The reviewer takes exception to this statement, disagreeing with the opinion of Dr. Vaughan and other members of this school of thought. It is unfortunate that he has placed such emphasis on "food allergy." Many of the conservative allergists will not agree with him, as he has no scientific proof to substantiate such a broad generality. Likewise, many trained internists will heap criticism upon his head if they read his book. There are individuals who are specifically sensitive to certain foods, a small minority in the opinion of the reviewer. Far better and more accurate would the statement have been had he emphasized that often an inexperienced or over-enthusiastic allergist confuses the digestive symptoms of a patient, who is nervous and harassed by financial or domestic problems, for gastro-intestinal or "food" allergy. Fortunately in part five the author mentions the possibility of such confusion.

Thus with one exception, and an important one, the book contains many entertaining and instructive characteristics of a fascinating and baffling variety of affections.

Mr. Tillery's illustrations are unique and amusing, but at the same time they portray accurately many of the complicated problems of immunity and they greatly enhance the value of the book to the reader.

LESLIE N. GAY

A STUDY OF THE PSYCHOPATHIC PERSONALITY

The Mask of Sanity. Hervey Cleckley. 298 pp. \$3.00. 1941. C. V. Mosby Company.

"AN attempt to reinterpret the so-called psychopathic personality" is not a new line of endeavor in the field of psychiatry, but the work is worthwhile and to be recommended because it tends to crystalize thought and stimulate discussion of a topic in which there is little agreement and for which there is no satisfactory means of treatment. The theatrical title, "The Mask of Sanity," is belied by the orthodox psychiatric treatment of the subject and detailed presentation of case records. The evolution of the terminology from constitutional psychopathic inferiority and constitutional psychopathic state to psychopathic personality is described and the author offers "semantic dementia" as a new contribution to this poorly defined and unexplained group of cases. The vagaries of nomenclature are described clearly, and the author recognizes gradations of personality deviation included under the general term psychopathic personality, yet he speaks of "the psychopath pure and simple" and "thorough and complete psychopath," referring to the condition as a disease entity. The author feels that he has not exaggerated or embellished the case histories in order to give a dramatic picture, but it appears that he utilized fully the most illustrative material available and his vividly descriptive and excellent vocabulary. In the fifteen detailed case histories presented the influence of alcoholism is emphasized in fourteen; the reader at times is impressed by the alcohol problem as much as by the personality deviation. The study is based largely upon patients admitted to a hospital of the Veterans Administration for the care of ex-service men, which eliminates women patients

from consideration, and notably influences the context.

The volume would be instructive to the courts, which often mishandle these cases, as well as to the physician who also not infrequently fails to be of material assistance in solving the problem. The psychopath is treated as a criminal on one occasion, as mentally ill on another and again as a normal human being. To this the author offers objections, believing that the psychopath is always psychotic. His objections are not entirely valid because the current psychiatric attitude is one of "more or less" instead of "either or, one or the other, all or none"; there can be therefore no dogmatic advice as to treatment and disposition of patients who suffer from personality variants.

A brief review of the literature on the subject brings forward the various opinions of recognized authorities which illustrate that little improvement has been made in our concept of these socially maladjusted individuals since they were originally termed "moral imbeciles" in England. The best characterization of these patients is that they fail to profit by experience and are lacking in goal-striving, self-criticism and guilt sense. The usual belief that the genius resembles the psychopath is quite correctly contradicted, because the genius performs with unmistakable purpose and achieves concrete end results; despite his bizarre conduct and uneven performances in his weak moments, his greatness comes only through strength and consistency of purpose.

The distinction between the pathological drinkers who are psychopaths and those who are neurotics is indeed interesting; it is emphasized that the neurotic drinker wants to recover, recognizes his inadequacy to face reality, tries to adjust to life with the remaining part

of his personality and reaches out for help. The prevalence of introversion in neurotic patients is properly stressed while the psychopathic patients are usually extroverted, aggressive, glib in their rationalizations and logical in their defense reactions—a pattern which they follow without gaining insight throughout life.

The author believes that psychopathic personality ("semantic dementia") represents a true psychosis and makes a strong appeal for the social recognition of the problems involved, the implication being that the psychopath is both neglected and mistreated. Certainly, he is mismanaged, but in the reviewer's experience he usually takes advantage of his opportunities cleverly, as illustrated by a case recently observed which had been admitted to a mental hospital thirty-five times, usually after becoming involved with the law, and had been discharged on each occasion after a time, usually by the courts, as without psychosis. The author's plea for a better understanding and more adequate facilities for the care and treatment of these unusual individuals is timely and worthy. I would add that a part of the educational program might well include a warning that society should not be too greatly influenced by the superficial and impulsively dramatic appeals of these irresponsible personality types. Psychopathic personality is perhaps as much a social as a psychiatric diagnosis, and it still remains questionable if the author's "semantic dementia" transposes it *in toto* to the medical sphere. The work represents much study and psychiatric interest in a subject which heretofore has been considered to be in the borderland of psychiatry.

RILEY H. GUTHRIE



Harvard College Library

GALILEO GALILEI, 1564-1642

Portrait of Galileo, first printed as a frontispiece to his book on sunspots and later used for the same purpose in other books. The cherub on the upper left is using one of the military compasses invented and sold by Galileo, while the cherub on the upper right is using an early form of Galilean telescope. Note that the latter is trumpet shaped. Later, Galileo simply used a cylinder or straight tube of lead.

THE PROGRESS OF SCIENCE

THE HERITAGE OF GALILEO

THE current year marks the tercentenary of the death of Galileo, who died on January 8, 1642. He was born in 1564, the year of the death of Michelangelo and of the birth of Shakespeare.

The achievements of Galileo are summarized in any book on the history of science, and information concerning his contributions to particular fields of knowledge may be easily had. But it is of some value to examine the general aspects of Galileo's work and to search out its meaning for our time. Recent years have been marked by many new Galilean studies. Those that take their place with the new classic books of Wohlwill, Fahie and Martin are chiefly two: L. Olschki's "Galilei und seine Zeit" and A. Koyré's "Etudes Galiléennes."

In his own day, Galileo made his reputation as an astronomer, although his official title was "Matematico straordinario dell Studio di Pisa, e Filosofo, e Matematico primario del Serenissimo Gr. Duca di Toscana." The notion of Galileo as astronomer lingers, although many persons are equally aware of his contributions to mathematics, mechanics and physics. His fame as an astronomer is largely owing to his good luck in having been first to look at the heavens through the telescope. But the subject wherein he overshot the mark of his time, and in which his work stands out now for us and for future generations of scientists and thinkers, is cosmology, for which, as a matter of fact, he "invented" his mechanics.

Galileo was interested in mechanics, because at heart he was a "gadgeteer" with true mechanical feeling. Thus one of his earliest discoveries was the isochronism of the pendulum which he applied to the invention of the *pulsilogium*, a device for recording and comparing pulse rates. But Galileo was looking for a proof and final vindication of the Copernican system. As early as August,

1597, he wrote to Kepler, "I adopted the opinion of Copernicus many years ago." He knew instinctively that Copernicus was right, but he had yet to find the reason why. The Copernican system was the simplest, the most elegant and the most beautiful. Furthermore, from the Platonic point of view, it was the most dignified, since it placed the sun at the center of the universe. That Galileo was a protagonist of Plato, in opposition to the followers of Aristotle, has been demonstrated with great clearness by Koyré.

It may be an exaggeration to say (as Martin and Wohlwill have) that the entire work of Galileo is to be conceived in terms of a struggle for the Copernican system of the universe. Yet it is clear that cosmological preoccupations dominated Galileo's thought to a very high degree. Let us see how they influenced his mechanics.

Galileo came to mechanics, because he had a natural bent for that subject—but also because he thought of mechanics as a cosmological science and the link between the earthly and celestial phenomena. The implication of this point of view is immediate: Find the laws of motion. Galileo's burden was thus to show that the planets follow their paths in the heavens by regular law and not, to use the then-current phrase, because each was guided by a "special intelligence" of its own. The search for the laws governing planetary motion led Galileo to a kinetical justification of astronomy, according to the system of Copernicus, which he expounded in his famous "Dialogues Concerning the Two Principal Systems of the World, the Ptolemaic and the Copernican," first published in 1632. Of course, the dynamical justification had still to await the guiding hand of Newton, but in the meanwhile the way was being prepared

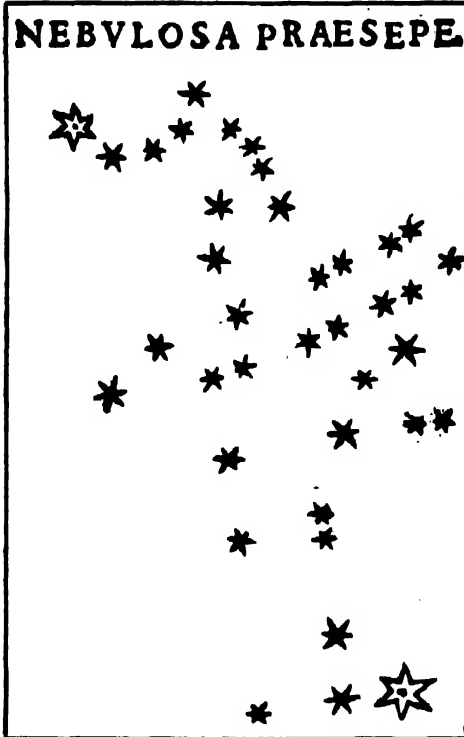

Harvard College Library

NEBULOSA PRAESEPE

or the Beehive Cluster in Cancer, called by Galileo the "Beehive Cloud." Due to the telescope, Galileo was able to see more stars in this group than any of his predecessors.

by Galileo and by his friend and correspondent, Kepler.

While Galileo was still figuring out the general plan of approach to his heavenly kinematics, *i.e.*, some 23 years before he completed the *Dialogues*, luck played into his hands: he heard of the newly invented telescope and forthwith set about figuring out how it worked. Soon he had reinvented the instrument; the early form of Galileo's telescope (trumpet-shaped) may be seen in the portrait reproduced herewith. The series of discoveries which he then made are well known. He discovered that Jupiter has 4 satellites revolving about it, that the surface of the moon is rough, containing mountains and craters, that Venus has phases just like the moon,

that the sun rotates and is "dirty," or covered with spots, that the planets all shine by reflected light, as the moon does. These were described chiefly in his "Sidereal Messenger" (1610) and his "Solar Spots" (1613).

In Galileo's mind, this chain of discoveries showed, above all, that the matter of the heavens greatly resembles that of the earth. He was more interested in regularities than in irregularities. Thus, to his own way of thinking, he had shown:

The moon is like the earth, being similar to it in surface appearance.

The planets are like the moon, since they shine by the reflected light of the sun.

Venus is like the moon, since it has phases.

The sun is like the earth and moon, since its surface is not perfect, but rather covered with blemishes.

Jupiter is like the earth, since it has attendants or moons.

Jupiter is like the Copernican solar system.

Now, too, Galileo could reply to the opponents of the Copernican system who thought the inferior planets different from the superior, and he could reply to the question frequently asked of Copernicans: Why should the earth alone have a satellite.

In this way there came finally into Galileo's hands the real wedge with which to enter and crack the Aristotelian system, not only for the world at large, but for Galileo himself. He was as much enmeshed in the old system as his contemporaries, but the difference was that Galileo was seeking a means of getting out of it. Instinctively he had known for a long time that the old system was wrong; now he knew why.

Galileo knew that he had the key, he knew that the classical distinction between sublunary and celestial matter was devoid of both truth and meaning. His discoveries, in other words, promoted matter itself—earthly matter—to celestial importance, *i.e.*, the importance formerly given to celestial matter alone. And at this point he was ready

and able to write his "Dialogues" and finally justify the "hypothesis" of Copernicus. Galileo's own statement of earthly versus celestial matter is extremely illuminating.

He says, in effect, that people have for centuries been writing about the crystal-line "pure" celestial matter which they supposed immutable, ingenerable, permanent and incorruptible, and which they contrasted to earthly matter, the chief characteristic of which is transiency or change. Well, he wonders, why is "change" thought of as so negligible? Like the gardener, he contemplated the perpetual cycle of "corruption and generation" with far more satisfaction than the supposed changelessness which characterized heavenly bodies. Thus he vaunted change at the expense of permanence. And, in any event, his own discoveries have shown that the heavenly bodies were far from perfect, and their appearance did not make them look immutable.

To make his point as well as possible—and we must never forget that Galileo was a consummate literary artist—he invoked a dramatic example. If the Aristotelians say, he wrote, that a jewel or a piece of precious metal is to be a chief object of admiration (because it resembles the immutable and incorruptible matter of the heavenly bodies), then he himself would prefer to admire a little plot of earth with a little tangerine (China orange) tree growing in it; here he would be able to watch it "sprout, grow up, and bring forth so goodly leaves, so odoriferous flowers, and so delicate fruit." Bearing both flower and fruit, the tangerine tree represented both fertility and fecundity, hence life itself.

Once Galileo had established the great principle of the uniformity of matter—celestial matter being exactly like earthly matter, and hence acting in the same way—then, to his mind, earthly matter was as worthy an object of study as the matter of the heavens. It thus became

as important to investigate the motion of a falling stone as of a star moving in its course. If the star in its course is subject to mathematical laws, then so is the falling stone. This was his cue, and without it there would have been no science of mechanics. His predecessors (such as the Paris School), lacking this cue, had been able to apply mathematics to the study of nature only in a half-hearted way.

Galileo felt his principal cosmological achievement to be the law of composition of movements—the analysis of all motions by means of components. This led him finally to the principal of inertia and the idea that motion unimpeded by the action of an outside force in a given direction would continue uniform and unchanged forever. By means of this principle, he was able to demonstrate that a stone dropped from the top of a high tower will fall at the foot of the tower, even if the earth is assumed to be in motion. In general, then, he was able to show that motions on the earth as we see and know them are compatible with the assumption that the earth itself is in motion. And, in one fell stroke, he thereby removed a host of the chief objections to the Copernican system.

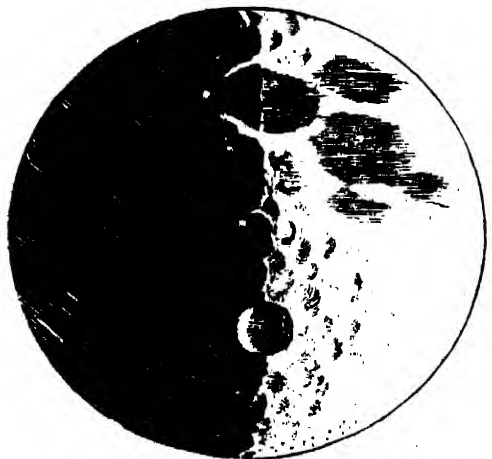

Harvard College Library

THE SURFACE OF THE MOON
AS SEEN BY GALILEO THROUGH HIS TELESCOPE
AND PICTURED IN HIS "SIDEREAL MESSENGER."



Harvard College Library

FRONTISPIECE OF GALILEO'S GREAT TREATISE

on the Copernican system of the world as contrasted with the Ptolemaic. His name appears as "Galileo Galilei Linceo," indicating his membership in the "Lincei," The Society of Lynxes, which group of scientifically minded Italians sponsored the publication of the book, and showing the three characters in the dialogues, *Salviati*, *Sagredo* and *Simplicio*.

All motions have an inertial component, unaffected by the terrestrial component, according to the principle of the composition of movement. The motion of the planets is, according to Galileo, purely inertial, without a terrestrial component and without terrestrial complications. By these new results, Galileo in his *Dialogues* justified the cosmology of the Copernican system, and showed that the earth could move according to the Copernican system without altering in any way the known laws of terrestrial mechanics.

Every one knows that after the publication of his "Dialogues," Galileo was summoned before the Inquisition and his cosmological speculations officially came to an end after he formally abjured his "errors and heresies." Now he had to confine his attentions entirely to the phenomena of the earth, and the results of his investigations were published in his great book on mechanics, "Dialogues Concerning Two New Sciences" (1638). Actually he was now led to precisely what it was he had been seeking all the time, namely a science of dynamics proper. And in this work, he completed his cycle of discoveries, showing that the principle of composition of movements, plus his determination of the true law of falling bodies, indicated that the path of a projectile was a parabola, and so on. By placing his mechanics on a firm basis, he actually justified his cosmology, and thus the circle of his life was completed.

The net effect of Galileo's work was the substitution for the older idea of a logical and teleological order of the newer idea of mathematical laws which apply equally to star and stone. The older notion of "fitness" was thus replaced by the new notion of "necessity." This is actually the basis of modern physics, since it entails the search for the true description of necessity, namely, the laws governing it, or mathematics.

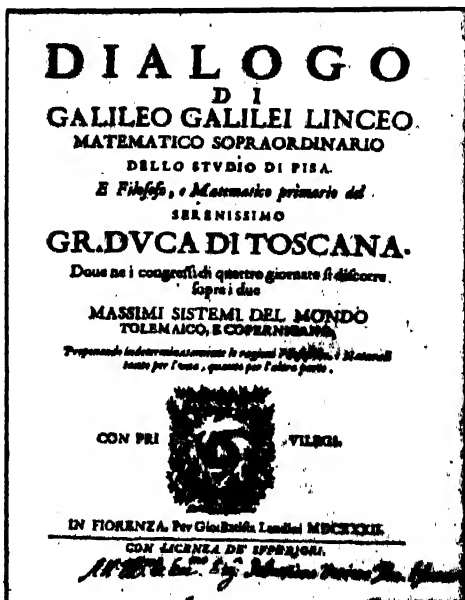

TITLE PAGE

TO "DIALOGO DI GALILEO GALILEI." THIS IS A PRESENTATION COPY, AUTOGRAPHED IN GALILEO'S OWN HAND AT THE BOTTOM OF THE PAGE.

The key-word to the thought of Galileo is *necessity*, which leads to mathematics. And the implications of that point of view are to-day at the basis of exact physical science.

WORKS OF GALILEO: 1.) *Sidereus nuncius* . . . (Venice, 1610); 1a.) *The Sidereal Messenger of Galileo Galilei* . . . trans. by Edward S. Carlos (London, 1880); 2.) *Istoria e dimostrazione intorno alle macchie solari* . . . (Rome, 1613); 3.) *Dialogo di Galileo Galilei . . . sopra i due massimi sistemi del mondo, Tolomaico, e Copernicano* . . . (Florence, 1632); 3a.) *Galileus Galileus his System of the World* . . . trans. by Thomas Salusbury: *Mathematical Collections*. vol. 1 (London, 1661) [new ed. in preparation by G. de Santillana, to be issued by Columbia University Press]; 4.) *Discorsi e dimostrazioni matematiche intorno à due nuove scienze* . . . (Leyden, 1638); 4a.) *Dialogues concerning Two New Sciences* . . . trans. by H. Crew and A. de Salvio (New York, 1914, 1933; Evans-ton, Ill., 1940).

I. BERNARD COHEN
HARVARD UNIVERSITY

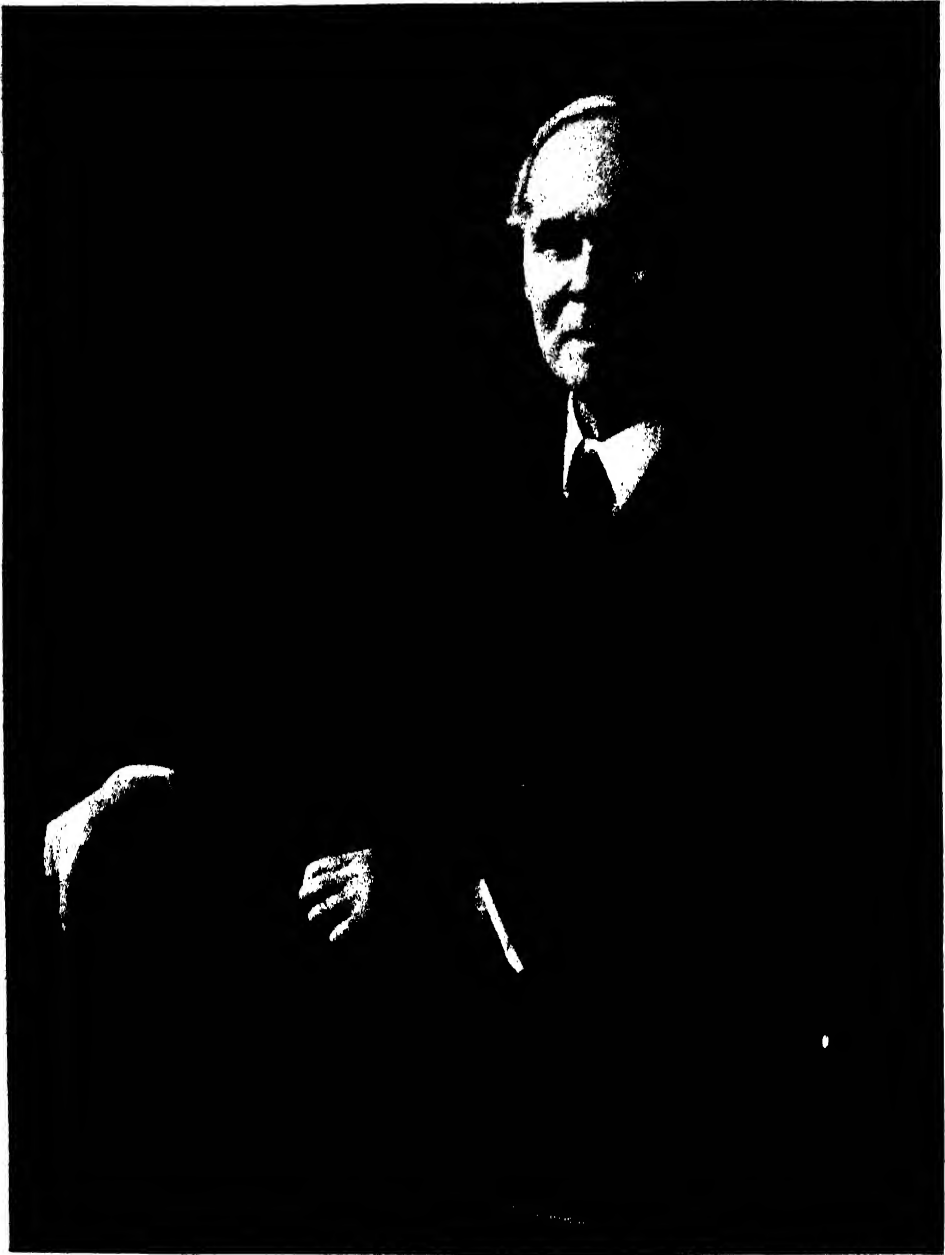

WILLIAM ALBERT NOYES

RESOLUTIONS ON THE DEATH OF WILLIAM ALBERT NOYES

WHEN he reached the age of eighty, the members of the department of chemistry addressed the following words to William Albert Noyes:

"Your numerous scientific discoveries, your successful promotion of societies and journals, and your inspiring guidance of students and colleagues have made your name immortal among men of science."

This great and illustrious man, nearing the age of 84, died on October 24, 1941. His death brought to a close the career of one of the towering figures in the development of the modern science of chemistry.

Dr. Noyes was born in the country near Independence, Iowa, on November 6, 1857. He received the doctor's degree in chemistry at the Johns Hopkins University under Remsen before reaching the age of twenty-five. In 1903, he became chief chemist of the Bureau of Standards; in 1907, he came to the University of Illinois as head of the department of chemistry, and continued in this position until 1926, when he became professor emeritus. During this period, the enrolment of the university trebled, while the enrolment in the department of chemistry increased six-fold. The leadership of Professor Noyes, his wise and infinitely careful selection of staff members, his judicious administrative and teaching policies were the chief factors in gaining for the department the national and international reputation it has come to enjoy. Dr. Noyes, by his spirit of fairness, by his personal integrity, and by his example of productive research, instilled a confidence in his staff which resulted in a spirit of cooperation that has become a tradition in the department of chemistry.

Among the extended list of publications and researches of Professor Noyes should be mentioned his determination of the atomic weight of oxygen, of hydrogen and of chlorine, the values for

which were accepted by the Committee on Atomic Weights.

Dr. Noyes was one of the leaders in the development of the American Chemical Society. He was the editor of its *Journal* from 1902 to 1917. In 1907 he founded *Chemical Abstracts*, a publication that is justly called the "Key to the World's Chemical Literature."

Dr. Noyes was the recipient of many honors, among which may be mentioned the presidency of the Indiana Academy of Science (1894), vice-presidency of the American Association for the Advancement of Science (1896), presidency of the American Chemical Society (1920), honorary degrees from Clark in 1909, Pittsburgh in 1920 and Grinnell (his alma mater) in 1929; memberships in the American Academy of Arts and Sciences the National Academy of Sciences, the American Philosophical Society; the Nichols medal (1908), the Willard Gibbs medal (1920), the Priestley medal (1935).

The interests of Dr. Noyes reached far beyond the domain of chemical science. His deep religious interest was expressed in a liberal faith which he always felt to be in harmony with scientific truth. He maintained a wide correspondence with scientific men the world over, with a view to the promotion of a better understanding of international problems. He was both a scientist and a humanitarian. In the words of Matthew Arnold, the life of Dr. Noyes may be described as that of a man who

Loved no darkness
Sophisticated no truth
Nursed no delusion
Allowed no fear.

The Senate of the University of Illinois expresses profound sorrow in the death of William Albert Noyes and its highest regard for his scientific achievements which were among the greatest of any one man ever connected with its history.

UNIVERSITY OF ILLINOIS SENATE



MARKING THE TWENTIETH ANNIVERSARY OF SCIENCE SERVICE

VICE-PRESIDENT OF THE UNITED STATES HENRY A. WALLACE (READING BEFORE MICROPHONE) WAS THE PRINCIPAL SPEAKER AT THE PROGRAM DEDICATING THE NEW BUILDING IN WASHINGTON AND CELEBRATING TWO DECADES OF SCIENCE SERVICE. DR. HARLOW SHAPLEY (CHAIRMAN OF THE EXECUTIVE COMMITTEE), DIRECTOR OF HARVARD COLLEGE OBSERVATORY, IS SEATED LEFT AND DR. EDWIN G. CONKLIN (RESIDENT), EXECUTIVE OFFICER OF THE AMERICAN PHILOSOPHICAL SOCIETY, IS SEATED RIGHT. STANDING ARE DR. CHARLES G. DARWIN, GRANDSON OF THE EVOLUTIONIST CHARLES DARWIN AND DIRECTOR OF BRITAIN'S NATIONAL PHYSICAL LABORATORY, AND DR. VANNEVAR BUSH, PRESIDENT OF THE CARNEGIE INSTITUTION OF WASHINGTON.

THE TWENTIETH ANNIVERSARY OF SCIENCE SERVICE

THE completion of two decades of public service and the dedication of its new building in Washington was the occasion of a day of celebration for Science Service at the end of 1941.

In a real sense it was a time of rededication to the objectives and principles set forth when Science Service was organized in 1921 and in the ten years of operation since.

Vice-President Henry A. Wallace was the principal speaker upon the radio program over the Columbia Broadcasting System that was devoted to a survey of the past two decades of science and a look into the future.

Other speakers on this program included Dr. Vannevar Bush, president of the Carnegie Institution of Washington, who is also director of the Office of Scientific Research and Development; Dr. Charles G. Darwin, director of the Central Scientific Office of the British Supply Council in Washington; Dr. Edwin G. Conklin, president of Science Service, and Dr. Harlow Shapley, chairman of the Science Service executive committee. The radio program was one of the "Adventures in Science" program conducted by Science Service over the Columbia Broadcasting System each week by Watson Davis, director of Science Service. This regular broadcast has been on the nation-wide CBS network since 1930.

A luncheon for Science Service trustees and the distinguished guests preceded the broadcast. In the late afternoon the trustees and staff of Science Service tendered a reception to several hundred invited guests who had the opportunity of inspecting the new Science Service building at 1719 N St., N.W., where the celebration was held.

This new building, which was occupied by the whole Science Service staff early in September, is just around the corner from the location of the first offices of Science Service in the rented building occupied by the National Research Council

during and just after the first World War. When the building of the National Academy of Sciences and the National Research Council was constructed opposite Lincoln Memorial in Washington, Science Service was invited to occupy space in the building. For 17 years Science Service enjoyed this location. With the approach of the second war and the growth of Science Service activity it became evident early in 1941 that Science Service would soon need a building of its own. A four-story structure of about 25 rooms was purchased and remodeled, and Science Service now operates from a quiet, centrally located home of its own.

Vice-President Wallace in his dedicatory address keyed that task of science and of Science Service in the past and the years to come. Mr. Wallace said:

One of the splendid agencies for the dissemination of pure truth is an organization affiliated with the National Academy of Sciences, known as Science Service. Science Service is not a money-making corporation but the non-profit institution for the popularization of science founded by the late E. W. Scripps when, during the first World War, he realized that the safety of democracy in the future would depend on all the people knowing more of the facts of science. Scripps was a newspaper man himself and knew what some scientists do not know, that truth can be popularized. And so the ideal of the newspaper man has been joined with that of the scientist and Science Service has been making available in a most unusual way the facts of the ever-advancing science of our day.

Science Service is animated with the ideal of serving the people and not exploiting them. The scientists who express themselves through Science Service know how important it is that the science of the future should be the agent of peace and abundance instead of warfare and exploitation. In the year or two immediately ahead, we have a tremendous job to do in defeating those who are using science for propaganda and destruction. In that job our own scientists will play an extremely vital role. When that job is done, science, properly directed, will open a new day, a day of abundance and peace for all the people.

WATSON DAVIS,
Director

ANCIENT CONCRETIONS FOUND IN NEW JERSEY

PECULIAR and comparatively rare fossil-like concretions, supposedly formed in the earth's crust thousands of years ago, often called "fairy stones," were turned up in great numbers at Stirling, N. J.

Workmen of the Works Projects Administration, during installation of a modern sanitary sewage system, were working through a bed of glacial clay when the stones were uncovered. They ranged in size from a half inch to four and five inches in diameter and, like those found in other parts of the world, were circular and nodular in shape.

Primitive man regarded these stones with awe and adoration, and the cognomen, "fairy stones," came down from early times. These people, finding concretions in the shape of some familiar object—a bird, a turtle or even a human torso—would assume that they were the homes of the fairies that created them and wear them as ornaments or talismen.

The scientific explanation of the for-

mation of concretions is vastly different. An aqueous solution seeping through a mass of rock comes in contact with a salt, a fossil or some substance other than the rock through which it is passing. A deposit forms around the foreign matter, which grows concentrically, some of which attain a size of many feet.

The age of the concretions found at Stirling has been estimated to be in the neighborhood of 25,000 years by Meredith E. Johnson, meteorologist for the State of New Jersey.

The concretions were embedded sixteen feet below the surface when found; it is estimated that they were 200 to 300 feet underground at the time they were formed. Erosion probably would have uncovered the Stirling specimens in the course of another few thousand years. Concretions bared by erosion and containing fossil remains also have been found in New Jersey along the shores of Raritan Bay.

E. M.



THE "FAIRY STONES"—FOSSIL-LIKE CONCRETIONS FOUND IN NEW JERSEY

EXPANSION AND DIVERSIFICATION OF SCIENCE

No better illustration of the rapid expansion of science can be given than the great increases in the memberships of scientific societies. For example, the American Association for the Advancement of Science was organized in 1848 with an initial membership of 461; its membership now exceeds 23,000, an increase of fifty-fold in less than a century. During the same period the population of the United States increased only six-fold.

With the exception of the American Medical Association, all the 182 societies which are affiliated with the association have been organized since it was founded and most of them within fifty years. Even the American Medical Association was organized in 1847, antedating the association by only one year. The total membership (including duplications) of the societies that are affiliated with the association is of the order of a million. However, not all the members of these scientific societies, and of many others as well, are professional scientists, but it is safe to assume that they are interested in science and realize the fact that the changes it has made in the world within a century are greater than those in all previous recorded history.

From the days of the ancient Greeks down to within approximately a century nearly all scientists were amateurs in the sense that they pursued their investigations purely for the pleasure of doing so, without any expectation or desire of receiving rewards for their efforts. One has only to recall the experiences of Archimedes and Ptolemy and Galileo to realize that the pathway of the scientist in those days was often thorny as well as toilsome. Although most eminent scientists now are professionals in the sense that they receive direct returns for their scientific work, yet many, perhaps most, of them are amateurs in the sense that it is the esthetic satisfaction they get from their studies that is determining

their careers. For many years most professional scientists were university and college professors, but during the past two or three decades governmental and industrial research organizations and laboratories have increased so rapidly in number and size that they are employing tens of thousands of scientists in the United States alone. A recently published directory of industrial research laboratories in the United States listed 1,769 of these organizations whose technical scientific staffs range in number from a few to two thousand. The most recent edition of "American Men of Science" contains the names of more than twenty-eight thousand persons whose scientific activities and achievements entitle them to be included in this volume. In addition to those included in this select list, most of whom hold positions as professional scientists, there are uncounted thousands of others whose deepest interests are the advancement of science and the increase of its usefulness to society. It is probable that a hundred thousand of our population are doing serious work in science.

It is so characteristic of populations, whether of human beings or lower animals, to increase slowly for a time and then accelerate at a more rapid rate only to be followed by a gradual diminution to a final static condition, that the resulting growth curve has been called a law and used for predicting the future. An interesting question is what point on the curve the increasing scientific populations of the United States and other western countries have reached. Judging from the continued increase in number and membership of American scientific societies, and especially from the phenomenal number of amateur scientific organizations, it is clear that the rising curve of science has not yet passed its steepest part. It is certain that an increasing fraction of our population will be engaged in scientific work. Nothing

is more urgently needed than scientific statesmanship—to borrow a word from the field of politics—to direct these miraculous new forces to the improvement of human beings and human society. The aim should be not only to provide new comforts and new opportunities for enjoyment, but to plant and grow in the very core of our being a much more perfect harmony with the fundamental qualities of the universe of which we are a part. From the enormous experience of our ancestors through tens of thousands of years we have glimpsed the orderliness of nature, we have developed a form of logic that corresponds to the relationships that exist among natural phenomena, we have acquired a conscience that whispers to us the deep wisdom of all human history, and we are often moved, perhaps somewhat like birds in spring, with vague yearnings for some distant and happier conditions. These precious human qualities have been acquired through the endless toil, disappointments, sufferings and tragedies of unguided experiments. What is now to be hoped for is a scientific statesmanship that will not stop with the transformation of our environment, but that, on the basis of all that is known about the fundamental properties of inanimate nature and about the enormously more complex ones of the animate world from amoeba to man, will organize progress in human nature and human relations by the relatively easy methods of science. Anything short of such a program would be to still the voice of the best that is in us and to be traitors to ourselves and our successors.

As great as the expansion of science has been in recent decades, it is no less remarkable than its ever-increasing diversification. When the American Association for the Advancement of Science

was organized most of science was classified under "natural philosophy" and "natural history." In its early meetings many of the programs of the association were attended by all its members. But with deeper penetration into natural phenomena, specialization rapidly and necessarily developed. The biological sciences quickly divided into zoology and botany, and each of these into many subdivisions, and similarly with other sciences, until there are now hundreds of scientific societies devoted to the interests of special fields.

The work of the association is organized under fifteen sections, ranging in fields of interest from the abstractions of mathematics to the concrete problems of methods teaching the rising generation. Each of these sections organizes programs, often in cooperation with the affiliated societies whose special interests lie in its field. In addition, the affiliated societies in many cases have their own programs, sometimes independently of all sections of the associations and other societies, and sometimes in cooperation with other societies.

The association has a vice-president for each of its fifteen sections, a man eminent in its field. Each vice-president delivers a vice-presidential address, usually at the termination of his term (one year) of office. These addresses are published in *Science*, which becomes, because of even these addresses alone, the greatest place of record of syntheses of scientific progress in this country. The fact that any specialist in one field may find many of these addresses beyond the range of his deepest interest, and perhaps not easy fully to comprehend, is not sufficient to justify their neglect, for isolation leads eventually to sterility.

F. R. MOULTON,
Permanent Secretary

THE SCIENTIFIC MONTHLY

APRIL, 1942

MINERAL RESOURCES OF THE PHILIPPINE ISLANDS¹

By Dr. ALDEN CUTSHALL

DEPARTMENT OF GEOLOGY AND GEOGRAPHY, UNIVERSITY OF ILLINOIS

THE Philippine Islands are principally an agricultural country, and their important agricultural exports (sugar, hemp, copra, coconut oil and tobacco) are widely known. However, this American outpost is not lacking in mineral resources. With a few exceptions the exploitation has been confined to the last decade, yet mining is now one of the major industries of the Archipelago. The rise has been next to spectacular and, in value, now ranks second to sugar, which for many years has been considered the premier industry in value of exported products. Hence, mining will probably be given full consideration in any economic planning of the country or any post-war adjustment in the Orient.

In contrast to Philippine agriculture, which received its stimulus largely from the United States, the Philippine government has sponsored the development of the mineral wealth of the islands. Systematic mining operators in this country have relied upon the U. S. Geological Survey, but no comparable agency exists in the Philippines. Their own Bureau of Mines and the National Development Company supervise the mining industry, but an organized survey of reserves is

needed. Foreign development of the mineral resources has been restricted, the recent progress having resulted from insular initiative and capital. The American touch is evident, however, inasmuch as American machinery is used and many of the mining engineers are Americans.

Prior to 1907 there was no mention of minerals in the statistical records, and as late as 1932 the "Statistical Handbook of the Philippine Islands" gave only three of the 281 pages to mineral production. The rapid growth can best be realized by referring to Table I.

TABLE I
MINERAL PRODUCTION IN THE PHILIPPINES,
1908-1941

Year	Metalllc	Nonmetalllc	Total
1908	P 460,000 ^a
1918	2,800,000
1928	P 3,890,860	P 15,275,349	19,166,215
1929	6,895,329	8,094,677	14,990,006
1930	7,534,179	8,748,787	16,282,966
1931	7,825,408	8,262,373	15,887,841
1932	10,314,183	10,166,312	20,480,492
1933	16,346,255	5,597,827	21,944,082
1934	11,704,144	4,400,134	16,104,278
1935	18,671,266	4,801,275	21,472,541
1936	25,832,878	5,403,127	31,036,005
1937	55,741,175	6,623,939	62,365,114
1938	72,621,473	6,316,405	78,937,878
1939	78,670,000 ^b
1940	90,195,000 ^b
1941	79,840,920 ^c

^a One peso (P) equals \$0.50.

^b Approximate value.

^c Value of gold production alone.

¹ The statistics on mines and mineral production were obtained from the *Philippine Journal of Commerce*, *The Philippine Statistic Review* or the United States Department of Commerce *Minerals Yearbook* and press releases.

Of the total mineral production gold ranks far in the lead, but the recent rise

of the base metal industry is significant. Iron ore, which is the most abundant, leads this group, but the ferro-alloy ores of manganese and chromium are very important. The latter probably has the more promising future because of the large reserves and the technological advances which permit low-grade ore, to which the bulk of Philippine reserves belong, to be used in the steel industry as well as for refractory purposes. Copper, lead and zinc are metals of lesser rank, and coal, construction materials and asbestos are non-metals of commercial importance.

GOLD MINING

The mining industry of the Philippine Islands is essentially gold mining, for it amounts to more than 80 per cent. of the annual mineral production. Gold mining has been carried on in the islands since time immemorial, for as early as the third century Chinese writings mention gold as one of the principal products of Luzon. With only a few exceptions the 41 producing mines to-day have been worked at some time in the past, abandoned, then rediscovered and reopened. In some cases the present discovery resulted from the presence of ancient workings, whereas in others the current development has uncovered the older workings. Of the many companies organized before 1930, only three have survived.

Gold production means both gold and silver for the two metals usually occur together. By weight the ratio between these two precious metals is about one to one, although there is a wide variance from mine to mine. Some copper and a small amount of lead are also obtained as by-products of gold refining.

The value of gold taken from Philippine deposits was practically nil until World War I, then increased irregularly until the middle thirties. But following the gold rush of 1936 large-scale exploitation has characterized the industry.

Technological advances and the rise in price of gold (\$35 per ounce) have stimulated prospecting throughout the islands, encouraged the formation of new companies, and induced older establishments to enlarge their plant capacities. Philippine production surpassed that of Alaska in 1935 and now ranks second to California (Table II). Only the Union of South Africa, Canada, the United States and Australia had a larger production than the Philippines in 1941.

TABLE II
GOLD PRODUCTION IN THE UNITED STATES AND TERRITORIES, 1941

	Fine ounces	Per cent. of total	Decrease
California	1,411,800	24	- 3
Philippine Islands	1,109,659	19	*
Alaska	600,649	12	- 9
South Dakota	610,223	11	+ 4
Colorado	377,503	6	+ 3
Nevada	372,300	6	- 2
Utah	347,784	5	+ 7
Arizona	315,000	4	- 10
Montana	246,500	4	- 2
Idaho	150,000	3	+ 12
All others	205,445	4	- 2
Total	5,558,671	100	

* Less than one half of one per cent.

Gold-mining claims have been filed in practically every province, but only eight actually have an operating mine. Active production has been limited to four districts: (1) Mountain Province, Luzon, frequently referred to as the Baguio Mining Region, is the oldest and most important gold-producing area; (2) the province of Camarines Norte, southeastern Luzon; (3) Masbate, an island of the Visayan group; and (4) mountainous Surigao in eastern Mindanao. Of these four, Masbate is the region of older development, ranking first from 1910 to 1920, second from 1921 to 1933 and third since 1934. Mountain Province has been the number one area since 1920 and Camarines Norte has held second position since 1934. Of the 1938 total, Mountain Province, with the first, second, third and fifth producing mines, contributed 63 per cent.; Camarines Norte, 16 per cent.; Masbate, 12 per cent.; Surigao, 5 per cent.; and Bulacan,

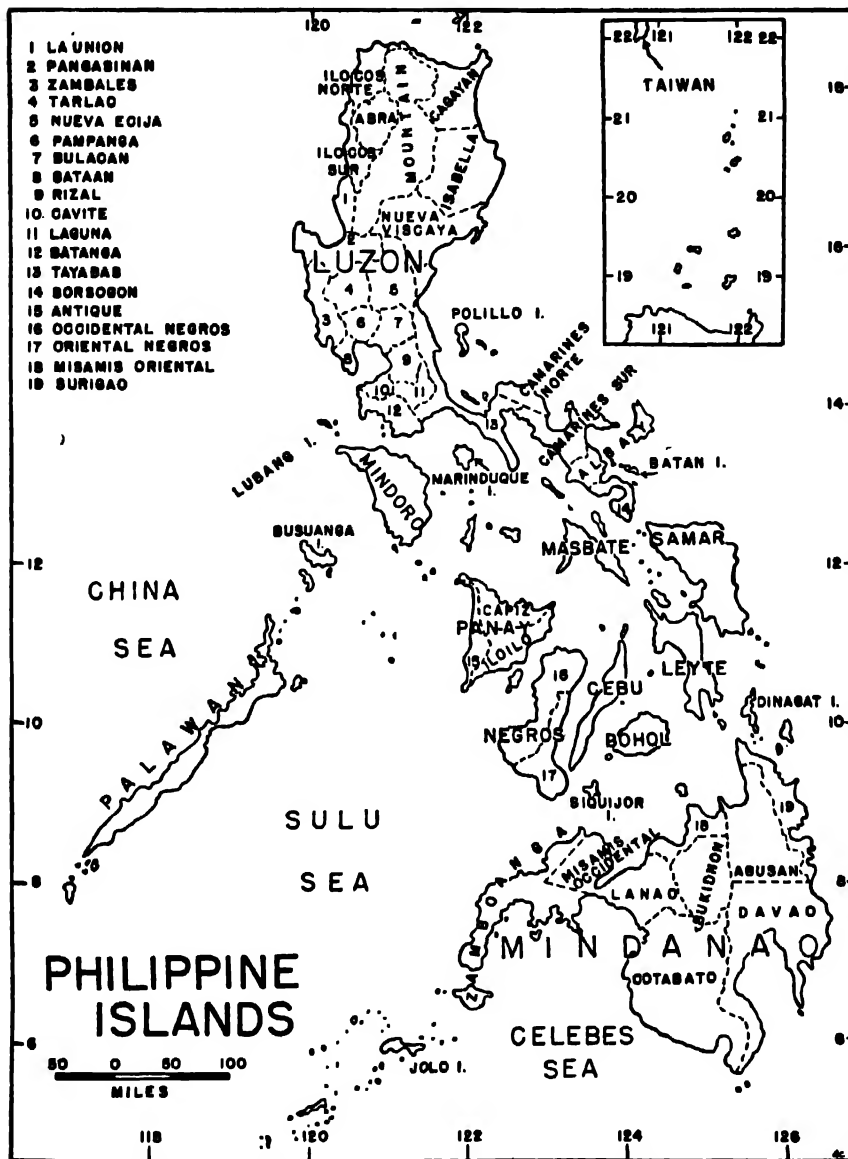

PRINCIPAL ISLANDS AND POLITICAL DIVISIONS OF THE PHILIPPINES.

Zamboanga, Camarines Sur and Marinduque the remaining 4 per cent. It is probable that the present order of the four leading districts will continue for some time.

Both placer and lode deposits are worked in the Philippines, but only four of the 41 producing mines are placer

operators. These four mines, only one of which is really significant, had a combined production of two and two thirds million pesos, or about 4 per cent. of the total output in 1938. Nineteen mines produce 95 per cent. of the gold, and the four leading mines in Mountain Province supply one half the total. Gold produc-

tion increased every year between 1927 and 1940, and approximately 30,000 men have been employed in the gold-mining industry for the last three years.

IRON ORE

For a long period leading up to the close of 1933, Philippine iron mining was confined to that limited amount which supplied the needs of the local iron industry. This was principally the manufacture, by primitive methods, of cast iron plow shares and plow points for local use.

The Philippine Iron Mines started with a low output in 1934. The following years its output, wholly for export, increased almost forty-fold and 1936 production more than doubled that for 1935. Other companies were organized and, except during 1937, production increased steadily until the recent invasion. Almost all the ore was shipped to Japan, and iron mining probably furnished employment for more than 3,000 persons. By way of comparison, the Philippines, in 1940, mined almost one half as much iron ore as Australia or about as much as was mined in the state of Wisconsin.

TABLE III
IRON ORE PRODUCTION IN THE PHILIPPINE ISLANDS, 1934-1940

Year	Metric tons
1934	7,239
1935	283,310
1936	654,456
1937	601,190
1938	910,952
1939	1,154,738
1940	1,191,641

The important iron-mining areas are Bulacan, Camarines Norte, Surigao, Samar and Marinduque. Bulacan ores have long been worked in primitive fashion for local use, but reserves are limited and little if any ore has been exported from this region. Camarines Norte has been the leading area of export. The ferrous content of the ore is high, 61 per cent.; but the estimated reserves approximate only five million tons. In contrast the Surigao reserves have

been estimated at 500 million tons, one of the larger ore bodies of the world. These lateritic ores are found in the northeastern part of the province of Surigao in beds varying up to nine feet in depth. This area is, in reality, two adjoining beds of ore, low in silica, phosphorus and sulphur, and having an average ore content of about 48 per cent. The deposits are near a good harbor and can be mined with moderate capital and operating cost; but even so, this was the last area to be developed. Little is known about the iron ore of Samar and Marinduque, but these islands have contributed materially to the islands' export of iron ore since 1938.

CHROMIUM

Philippine chromite deposits are of especial interest to the United States because 99 per cent. of the chromium used in this country is imported, most of it, until 1937, from Turkey, Rhodesia and the Union of South Africa. The most important application of chromite ores is in the manufacture of ferrochrome, which in turn is used to make chromium steel for the motor car industry and in alloys with other metals for tool steel and "rustless" steel. The second large consumption of chromite is for lining furnaces in the manufacture of refractories. The latter industry can use a lower quality of ore, and thus far much of the Philippine ore has come under this classification.

It was not until 1935 that chromite production in the Philippines was sufficient to merit inclusion in the trade statistics of the islands. Four years later chromite led in production among the base metals. Exports to the United States began in 1936, and most of the production has been shipped to this country each year. In 1940, a year that set a new all-time high, for we imported approximately one half the world's total production for that year, the Philippines supplied almost one fourth of our chro-

MINERAL RESOURCES OF THE PHILIPPINE ISLANDS 299

mium imports. In 1939 the Philippines were the fifth ranking producer of crude chrome, only U.S.S.R., Turkey, South Africa and Southern Rhodesia outranking the upstart producer which accounted for 11 per cent. of the world total.

TABLE IV
UNITED STATES IMPORTS OF CRUDE CHROMIUM,
1936-1940
(Long tons)

	Total imports	Imports from P.I.	Per cent. of Philippine production
1936	324,258	4,986	77
1937	533,916	43,648	91
1938	352,085	78,233	90
1939	317,511	71,912	98
1940	657,689	156,566	95

Chromite ore has been mined in Camarines Sur, Zambales and Dinagat Island, a small island a little north of Mindanao. Exportation of ore, more than 55 per cent. chromic oxide content, for Camarines Sur began in 1936, but reserves were limited and have evidently been worked out, for no ore was exported from this province in 1940. The Zambales deposits, believed to be among the largest in the world, contain about 10 million tons of ore. Although discovered in 1933, no production was recorded until two mines began shipments in 1937. A third mine began shipments in 1939 and these three producers supplied 99 per cent. of the 1940 total. The remaining one per cent. was mined on Dinagat Island, but lesser bodies of ore are known to exist on the island of Samar and in Surigao, Mindanao. The largest Zambales mine (79,000 tons) is producing a low grade ore, 34 per cent. chromium oxide, which is used principally in refractories; but the other two (68,000 and 15,000 tons, respectively) are mining ore averaging about 50 per cent. chromium oxide.

MANGANESE

Deposits of manganese ore are known to occur in many parts of the islands,

but no comprehensive survey of reserves has been undertaken. In general, Philippine manganese is of medium quality, but it usually occurs in powder form, which is not the most desirable for industrial purposes. Manganese mining does not require highly skilled labor or large expenditures for milling equipment. The ore is taken from shallow, open pits, and much of the mining, washing and selecting of ore is done by women.

The first manganese shipment to the United States was during 1935, although the pioneer company began operations in 1934. It used Philippine labor and capital, but an American superintendent was in charge. During 1938 manganese ores of commercial importance were worked on the islands of Luzon (Camarines Sur and Ilocos Norte), Masbate, Bohol, Panay, Siquijor and Busuanga. By far the principal tonnage has come from the two last-named islands, both of which are small and contain no commercial deposits of any other mineral. Siquijor is south of Cebu and Busuanga lies between Mindoro and Palawan. The latter has the better ore, uniformly over 50 per cent., and four mining companies operate on the island. The Siquijor deposits average 42 per cent manganese and have been mined intermittently since 1937. Production has come from several individual areas, and this island has probably accounted for 40 per cent. of the entire manganese production of the islands. The ore has been shipped to United States, Great Britain and Japan from the ports of Manila, Iloilo, Cebu, Aparri and probably others.

During 1940 Philippine production amounted to 58,038 metric tons, a 61 per cent. gain over 1939 and 40 per cent. more than was produced in continental United States during that year. This ore was 45 to 50 per cent. manganese, which would tend to disprove the general conception that Philippine manganese is of low quality. The above figure compares favorably with the average for Brazil

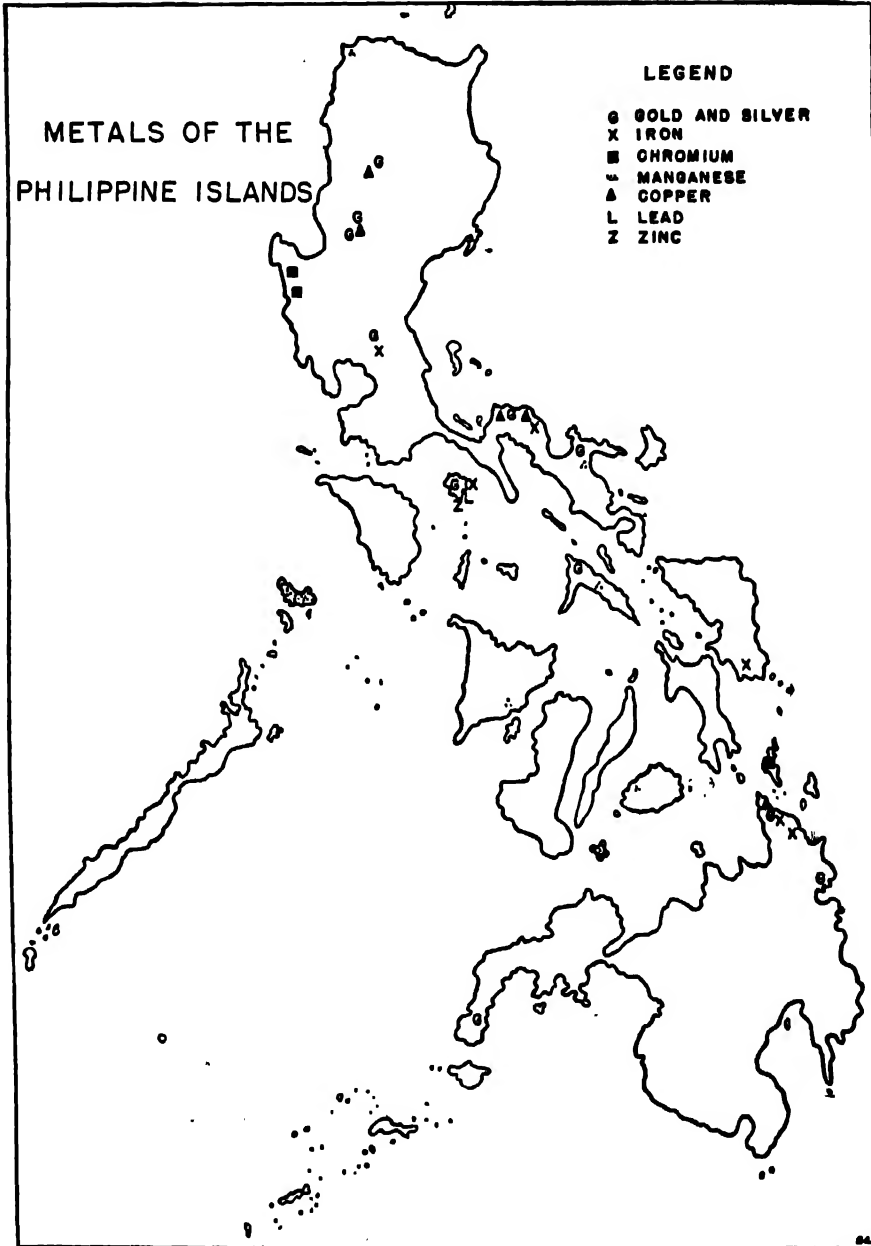

THE MINERAL PRODUCING AREAS OF THE PHILIPPINES ARE SCATTERED THROUGHOUT THE ARCHIPELAGO, BUT THE GREATEST DEVELOPMENT HAS BEEN CONCENTRATED ON THE ISLAND OF LUZON.

(38-50 per cent.), India (47-52 per cent.), Russia (41-48 per cent.), and South Africa (30-51 per cent.), the principal producing countries. However, selective mining is practiced in the Philippines, and this is probably not true in the other producing countries. In 1940, 89 per cent. of the ore was shipped

MINERAL RESOURCES OF THE PHILIPPINE ISLANDS 301

to this country as compared to only 32 per cent. the previous year, the exports to Japan having decreased since 1938, when 98 per cent. of Philippine manganese went to the Land of the Rising Sun. The Philippines, although not a major manganese producer, were surpassed by only nine countries in 1940, and only five of those supplied more ore to the United States.

Philippine manganese producers face several difficulties: (1) a monopoly controlled market; (2) high ocean freight rates; and (3) low to medium quality and high moisture content (10 to 14 per cent.) of the ore. Because of the last-mentioned difficulty, selective mining of most deposits is essential and some washing or screening is necessary to increase the grade. In view of the present world abundance of natural metallurgical ore little has been done along manganese ore beneficiation. A possible solution might be a Philippine ferromanganese plant, using cheap electric power; hence a processing operation near the source instead of at Niagara Falls, where most American plants are located.

OTHER METALS

Copper, lead and zinc are, next to iron, used in large amounts in modern industry. The United States is self-sufficient in these metals and, therefore, not a favorable market for Philippine output. All three are present in the islands, but their production is still comparatively undeveloped and the quantity of reserves still unknown. Each is produced locally, principally as a by-product of gold and silver mines. The export, then, is partly in the form of ore but mostly as concentrates and unrefined furnace products.

The export of copper was reported for the first time in 1936 and, except for a slump that coincided with the collapse of the Manila stock market in 1937, has continued. In 1938 eight mines produced not less than 30,000 pesos of cop-

per each, but only one reported copper as the principal product. Production for 1939 increased 110 per cent. over that of the preceding year and the output for 1940 was 24 per cent. above that of 1939. The Lepanto and Hixbar mines remained the principal operators, and Japan took most of the 9,259 metric tons produced. United States imports of Philippine Island copper concentrates surpassed two thousand tons.

There is also only one mine, Mineral Resources Mine in Marinduque, that produces lead as its principal product. The 1937 production was valued at 94,389 pesos and increased 141 per cent. in 1938. Exports were sent to the United States and Japan in somewhat equal amounts. Zinc is another product of this company, but its output has been relatively insignificant.

Other metals have been reported and in some cases mined locally but only in relatively insignificant amounts. Included in this group are tin and tungsten from Palawan, molybdenum from Panay (Iloilo), platinum from Mindanao (Agusan and Bukidnon), mica from Ilocos Norte, nickel and mercury. None of these can yet be listed as positive assets of the country.

NON-METALS

Production of non-metals in the Philippines was equal to, and in some cases exceeded, the metal production prior to 1933. Since that year non-metallic production has lagged behind until its value was only about 9 per cent. that of the metals in 1938.

Rich deposits of the fuel minerals are lacking. Coal-bearing strata are widely distributed (Batan Island, Cebu, Malangas, Masbate, Mindoro, Polillo Island, Sorsogon, Sugud Bay, Tayabas and Zamboanga) but proven reserves are limited. The coal is described as "too young," and it occurs in thin beds which have been broken by surface movement, thus mining is both dangerous and costly.

Native coal consumption has been supplied largely by one mine on Batan Island in the province of Albay and by small operators in Cebu. Except in scattered and limited localities, Philippine coal is not suitable for coke and is used principally as steam coal. It has been suggested that it might be used for the reduction of metals by non-coke methods or for the extraction of its by-products for chemical raw materials, but since the amount is limited these proposed uses appear improbable. In most respects local coal can not compete in price and quality with coal from Japan and Australia, the two coal exporters in that part of the world. All the mineral oil consumed in the Philippines comes from abroad, 80 per cent. from the United States. Petroleum seeps, residues and natural gas emanations have been found in eight provinces ranging from north central Luzon to central Mindanao, and are usually associated with folded tertiary shales and sandstones. Wildcat operations have been wide-spread, but none has resulted in a producing well. (There is one producing asphalt deposit in northwestern Leyte.) The more promising areas are Bondoc Peninsula, Tayabas and the central plain of Luzon as the formations appear more favorable in those regions. About four years ago the National Development Company engaged the services of several American geologists for a geological survey of possible coal fields and petroleum areas, but their findings have not yet been published.

Other non-metallic minerals have been utilized only limitedly. The cement industry is important, but local gypsum is in the mountainous interior and of the fissure-filling type, so the needs of the cement plants have been supplied from foreign sources. Asbestos has been mined locally in the mountains of Ilocos Norte, Zambales, Pangasinan and Agu-

san, most of it having been shipped to Japan. Quartz sand from Lubang Island, Mindoro has been used in local bottle-making, and several other silica areas are available. There are sulphur deposits in the many volcanic areas, but known deposits are small and access to them is difficult. Even though deposits exist in several provinces, the supply is considered inadequate to meet the demands of a sulphuric acid plant. Natural fertilizer in the form of guano is plentiful, but is no longer in demand. Evidently this has been supplanted by the importation of chemical fertilizer, 60 per cent. of which comes from the United States. This importation amounted to \$1,500,000 in 1938, a decrease of about 40 per cent. over the 1936 figure. Sand and gravel, limestone, marble and pottery clay are available in considerable quantities. Except for road material, some local building construction and cheap stone for riprap, however, these materials are unused.

MINING REGIONS

From this discussion, four mining regions of the Philippines stand out, and three of them are on the island of Luzon. (1) Mountain Province, Luzon, produces 63 per cent. of the island's gold and is also important for silver and copper; (2) the southeastern peninsula of Luzon and the nearby islands of Masbate and Marinduque have a great variety of minerals, of which gold and silver, iron, copper, lead, manganese and zinc rank in the order named; (3) the mountainous Zambales area yields 99 per cent. of the chromite exports and a little asbestos; and (4) in Eastern Mindanao, especially the province of Surigao, gold and the vast iron reserves rank of foremost significance. These major regions do not include the smaller islands that are important for manganese, chromite or coal or the scattered areas of limited or untested mineral wealth.

ASIATIC SURVIVALS IN INDIAN SONGS

By Dr. MARIUS BARBEAU

ANTHROPOLOGIST AND FOLK-LOUISIAN, NATIONAL MUSEUM, OTTAWA, CANADA

THE Siberian origin of our northwestern natives can no longer be doubted. Abundant evidence, gathered for the National Museum of Canada in the last twenty years, shows how the Athapascan nomads, after they had crossed Bering Strait into America, spread in various directions over a large part of our continent. Some of their roving bands, following the game, journeyed south along the Rockies, or down the northwest coast, where salmon was plentiful. Many of them scattered over the vast swamps of the far north almost as far as Hudson Bay, while others ascended the Mackenzie into the grasslands of the prairies. Once they had discovered the buffalo, they vied in the hunt with the earlier prairie occupants, eventually displacing some of them with hammerblows. For they were of the breed of the Tartars. They penetrated as far south as Arizona, and were only prevented by the white man from invading Mexico, as the Aztecs had done a millennium before.

The recent recording of the songs of the northwestern Indians has provided an opportunity for a study of their relationship to Asiatic songs. The results have been startling. Some of the songs, from both sides of Bering, have proved so strikingly akin to each other that an intensive study of our museum collections of phonographic records, with the object of ascertaining whether the songs had a common origin, was bound to follow. Indeed, it is under way, and is likely to continue. A few conclusions, even at this early stage, may be of general interest.

Among Europeans, there is an ample supply of religious and ceremonial songs that are more than a thousand years old,

e.g., the Ambrosian music of the Catholic church which adheres to the musical language of the ancients. The innate conservatism displayed in the Ambrosian chants may be observed also in the rituals of other creeds. Songs, in set forms, do not readily change. Handed down from generation to generation, they naturally hark back to the past, sometimes a very remote past. Their tunes and words linger on and on and, often deformed, travel far from their birthplace. Indian ceremonial-songs, in this respect, do not differ from others.

But, curiously enough, the idea of comparing Indian songs with those of Siberia or China as a means of discovering the origin of the former, did not occur to me until recently. Still, plenty of material has been ready at hand for years. Nearly one thousand native songs of British Columbia and Alaska were recorded in the past thirty years for the National Museum of Canada, and many others are conserved in collections of the United States and Germany. Many ancient Chinese and Japanese songs have been marketed by the phonograph companies. Besides, over a hundred Siberian songs were taken down about forty years ago for the Jesup Expedition, and the records have long been stored away at the American Museum of Natural History in New York. They are now in the keeping of Columbia University (Anthropology).

When studying the Indian tribes of the Nass River on the Alaskan border some years ago, I heard on the phonograph a Japanese tune that arrested my attention. It closely resembled some of the songs of the Yukon and northern

British Columbia, which I had been recording among the natives.

The tune at the beginning scaled a high curve, touched a top note, then dropped over wide intervals to the bottom, where it droned leisurely, just as do the tunes of a number of typical Indian songs. The melodic resemblance between the Japanese and Indian songs reminded me of other things: the nearness of Alaska to Japan; the Mongolian features of both natives and Japanese; the fan-like migrations of the Indians away from Bering, which I had been probing; and the cultural stamp of Asia noticeable on the whole northwest coast.

Incessant contacts tended to reunite the related peoples on both sides of Bering, long after they had parted and those on our continent had strayed away to farther districts. Bering is only forty miles wide. It is dotted with islands, freezes over in winter and can be crossed in a day or two. The American and Siberian natives kept in close touch with each other for barter. A trade route extended, since prehistoric times, from Siberia into Alaska, and almost as far as Hudson Bay. The strait was navigated in skinboats during summer, and it could be crossed, over the ice, in winter. No real barrier ever interfered with those widely scattered people, who sought each other seasonally for the exchange of commodities essential to life. Customs and culture passed back and forth also, slowly but surely. There was no complete break.

Ancient traditions accompanied the early migrators in their trek eastward into the Alaskan tundras. It may be easily surmised that, together with other things, some of the ancient songs survived among them, at least in type or melodic pattern. Or else, newer songs might have spread from one end to another along the trade routes. Traders were wont to sing during the barter, to impress would-be purchasers with the

excellence of their wares. Asia had much to furnish. She was like a large container overflowing with riches into a still uncultivated and hungry America.

The little Japanese song I heard on the phonograph at the Arrandale cannery of the Nass was enough to remind me of all this. But to what use? To compare Indian customs and songs with those of northeastern Asia is not an easy undertaking, since materials must be secured at first hand.

After having transcribed for publication nearly one hundred British Columbia and Yukon songs, I recently showed about twenty of them to Professor Kiang Kang-hu, an eminent Chinese authority, then on the staff of McGill University at Montreal. The results of his inspection far exceeded my expectation, particularly when we came to dirge or funeral songs. I shall recount here two or three examples of these results.

A funeral song, the Dirge of Raven-drum, is the exclusive family property of Kweenu, a Raven chief of the Kitwinkul tribe, on the Grease-Trail between the Skeena and the Nass, in northern British Columbia. The ancestors of this family in the recent past migrated down from the north. Their traditional dirges, of which the following is one, were used only at the death of chiefs, and during the incineration of the body on a pyre.

The Raven drum now has come back. We can hear nothing but its large voice. It is like a great brightness.

The great voice of the Raven, the cawing Raven all covered with pearls, is ahead of me. We can hear nothing but its large voice. . . .

Professor Kiang said that this Indian song quite resembled a Buddhist chant for funeral services, used among the nomads of Mongolia. I had not told him, at the moment, that it was a funeral song of a family of Indians whose home stands in the Canadian Rockies, on the Grease-Trail, running southwards.

His statement led me to look for other significant similarities between the mortuary rituals and songs of Asia and the northwest coast. How startling a turn my comparison would take if the resemblance were to change to identity in such things as ritual forms (in the use, for instance, of similar drums to mark the rhythm), or the appearance of Asiatic words—perhaps Chinese words—in the songs! Buddhism, though in eastern Asia typically Chinese, has traveled far to the north, among the primitive Siberian tribes. It is familiar among the present Siberian tribes of Kamchatka, close to Bering. Who knows but it might have been there early enough to cross the strait with the ancient Siberian ancestors of the present natives of the Canadian Rockies!

The next song examined, the Dirge of the Eagles, was one that is found exclusively in a branch of the Eagle clan of the Kitwanga tribe, in northern British Columbia. This clan partook in the most recent invasion from the north. It has belonged to this district for less than two hundred years.

I looked up to the sky. Daylight came down early from the East.

This funeral chant reminded Professor Kiang "very much" of a Chinese ceremonial song he had heard coffin-carriers sing in the streets of Peking. So, from Mongolia we had proceeded a step farther into China to find further similarities with Indian songs. But the next song, a second Dirge of the Eagles, brought us a real surprise. The very refrain was the same as that used in Chinese funeral songs.

Alas! alas! alas! alas! . . . (Hayu, hayu) The chiefs mourn the last survivors of Gyostanraet. Alas! alas! . . . Now that the great chief has died, it is as if the sun were eclipsed. Alas! alas! . . .

My heart is full of grief, because the burial boxes of the other chiefs (unlike ours) are quite empty. Alas! alas! alas! . . .

The words of the main section of this song were in a local dialect, and referred to a fairly recent tribal event. But, to the singer, the refrain *Hayu, hayu, hayu!* was unintelligible, meaningless.

Not so to Professor Kiang, who was amazed. *Hayu* means "Alas!" in Chinese, and is exactly what dirge-singers in China are accustomed to exclaim in frequent repetition. It forms an habitual part of familiar Buddhist rituals. The Indians of the northwest coast were unaware that they were singing a Chinese religious refrain. This was indeed a significant and startling discovery.

Looking over a number of other songs, I find that the refrain *Hayu* (alas!), wherever it appears, is used with the right context, *i.e.*, in songs of mourning over the death of a relative, and that, in every instance, it is employed by members of the Eagle and the Wolf clans, both of which were recent invaders from the far north.

The sing-song-like way of moaning because of the death of relatives and friends, familiar among those Indians, suggested other striking resemblances in mortuary customs. While I was at the Arrandale cannery, on the Nass River, close to the Alaska border, during the fishing season of 1928, a tragedy brought grief to the natives stationed there. Several of them died of poisoning, after eating decayed salmon roe. Dirges broke out early one morning, and throughout the following days women could be heard moaning in the woods.

As soon as the news of the misfortune broke out in the summer village, old women began to wail pitifully. Crouching on the ground in front of their houses, they tore their hair and beat the ground with their foreheads. For once in their lives, those Indians cast restraint to the winds and gave vent to grief. Professional mourners, like those of ancient Greece, rent the air with their

lament, and sprinkled ashes on their heads.

"Just as it would happen in China!" Professor Kiang added after I reported the occurrence to him. "There also mourners pound the ground with their foreheads, and they are paid for it. Quite typical!"

From the dirges, quoted above, Professor Kiang and I passed on to others. One of the most striking, because of its strange melody, was *Hano!* (a funeral song belonging to a leading Wolf clan of Gitlarhdams on the Upper Nass.) Somehow it seemed quite familiar to Professor Kiang, "It sounds very much like a Buddhist chant in a funeral service," he declared. "This chant comes from Hindu music." Another link in the long chain of origins: from Alaska, we pass on to Siberia, to China, to India.

Another Indian dirge of northern British Columbia, that of Small-Raven of Kitwanga, "sounds like a night-watchman's song in Pekin," said Professor Kiang. "The watchman goes out and shouts: 'Be careful of your fire and your doors! Beware of thieves!'" Drum-beats accompany the night-calls. The rhythm of the Indian dirge, Small-Raven (Hlkwaq), also is marked by drum-beats.

Hohaleanagwah, I bemoan the small human-like Raven of my sorrowful heart. . . .

The Raven here is the principal emblem of the singer's clan, which passes on to a new holder after the death of the head-chief. The song also includes the words: "I am left alone. Broken-hearted am I when I take his place, for I remember all my ancestors."

Other native songs from British Columbia likewise resemble Asiatic songs. For instance, a lyric tune of the Yukon and the Northwest, often called a "love" or a "mountain" song, "Honekone," was "like a harvest song of China. Girls

sing it while working in the fields and picking tea leaves." Like many Asiatic songs, its melody is in the pentatonic scale.

Another, a lullaby of the Nass (that of Nampks) "resembles a Chinese shepherd song. It is very much like it."

A "peace song" of the Haidas and the Nass people, the works of which are in a foreign language not understood by the singers, is reminiscent of "a Chinese sacrificial song." It was learnt by a Nass River Indian, the old singer's father, from Haida Indians on Queen Charlotte Islands. The Nass people had fought the Haidas long before, and peace had been restored after prolonged enmity. Nine canoes of the Nass tribes went to Tlawaq, on an island, and a feast was held. The Haida chief sang the peace-song during the ceremony. The guests from the coast of the mainland stayed there for three weeks and learned some of the songs of their hosts. After that time the Haidas and Nass people intermarried. The learning of the "peace song" by the singer's father shows how songs often travel from tribe to tribe. Many Nass River songs are in foreign languages, mostly those of northern tribes.

A lyric melody of the uplands, the "Fireweed" song of the Skeena headwaters, resembles a "Chinese street-tune." Its first part certainly sounds exotic, almost European, if heard among other Indian songs.

The Fireweed people will drink fermented juice with the Wolf and the Raven tribes. Why think you that we know not how to brew it? We walk about proudly, because we have made it for a long time.

Another song, a lullaby, reminds Professor Kiang of a Japanese lullaby, to the accompaniment of which Nipponese mothers, and Indian mothers also, gently sway the children wrapped upon their shoulders.

The use of the drum in the Indian

songs is an important element to consider in tracing their origin. The Indian drum of Alaska and the Canadian Rockies consists of a tanned skin dried and stretched over only one side of a closed circular band of wood. It is exactly similar to the instrument which the Koriak tribes of northeastern Siberia use in funeral rituals. Siberian drums, according to Jochelson,¹ are "covered on both sides with hide, like those found among the American Indians. . . . Together with drums covered on but one side" they "are used in Siberia only by the Buddhists," in "their divine services." Even in size the Siberian and Alaskan skin-drums are much alike, as our photographs show. In northwestern America, the drums were used not only in "divine services" but in rituals of incineration. For dead bodies, as in Siberia, were burnt on a pyre surrounded by dirge-singers and mourners.

In the light of these discoveries, a new field for investigations lies open before us. Theorists for many years have endeavored to explain the independent origin in America of cultural features known elsewhere. Primitive men were supposed to find within themselves the faculty of recreating the same processes over and over again wherever they might chance to be. For lack of historical records, it was impossible to check the application of the theory to features that refused to reveal their origins to investigators, and were accordingly swamped under a deluge of vague, if not sentimental, assumptions. But things may now take another turn, should the comparison of native songs on both sides of Bering prove that they go back to common Asiatic sources.

The new evidence under observation may turn out to be of a historical na-

ture, should it be finally established that an early derivative form of Buddhism long prevailed, as now seems practically certain, in the mortuary rituals of the northwest-coast Indians. Things like Buddhism and the Chinese mortuary rituals can not be considered essential to human nature. They are a culture growth, largely accidental, like all other such growths. Besides, there is explicit evidence of the migrations from Asia of the people themselves.

Once this is generally taken into account, many other so-called independent creations of prehistoric America are bound to prove derivations. Professor Kiang, impelled by the new drift of things, is already working upon a series of striking similarities, if not identities, between Mexican and Chinese civilizations. His work may be the beginning of the end for native American "insularity" in culture.

A thorough analysis of northwestern American and Siberian songs and rituals is an unavoidable step in the right direction. It is fortunate that it is now being undertaken. Over a hundred wax records of Siberian songs have been preserved, unpublished, for about forty years at the American Museum of Natural History in New York. They were recorded for the Jesup North Pacific Expedition to the Northwest Coast and Siberia. Their usefulness in the present investigation can hardly be exaggerated. I was startled, when I studied them early in January, 1933, with the definite evidence they yielded in a number of unforeseen directions. What was only conjecture without them, now becomes something demonstrable. Unexpected relations, of a semi-historical nature, are brought out between people on both sides of Bering—some of them far removed from each other—such as we had not even thought of before.

¹"The Jesup North Pacific Expedition," IV.

AN ANTHROPOLOGIST IN RUSSIA. II

By Dr. A. HRDLICKA

CURATOR OF PHYSICAL ANTHROPOLOGY, U. S. NATIONAL MUSEUM

A row of wagons tied to each other—the drivers sitting together on the last one for sociability regardless of the dust, talking, and the good little shaggy horses going it slowly alone. Have learned to love the Russian horse; he is not much to look at, but evidently has strength and sense and individuality.

A group of brownish Kirghiz at work on the tracks—try again in vain at stations to get postals with their pictures.

Sky still overcast, but no more chilliness, just agreeable warmth and the sun trying to break through. The train is most comfortable and one gladly forgives that it is not so very speedy. For second and first class such excellent trains are nowhere else in Europe, and but few in the West, in our own country.

The first rodent holes. Have not seen any at all before on this journey, nor any hares, rabbits, partridge, quail or other game. Only black crows, and the black-and-gray jackdaws. The wild flowers have changed again somewhat, some of them would look good in a garden; the wild-parsley-like plant is gone, but the daisy has reappeared, though not in large quantities. Here the Trans-Siberian is already double-tracked, or being so made—had it been so before the Russo-Japanese war the results might have been very different. . . .

And now, as we near Taiga, the ground becomes definitely more uneven, at first only long depressions and low ridges, later little irregular hills—though no stones yet. And not one tenth, perhaps not one twentieth, of this fine ground as yet utilized. A propitious region, waiting for man. The thick grass and weeds show it is fertile and even in part well watered.

First swallows, first magpies. Once in

a while a wagon, a hut or a red skirt or kerchief in the landscape.

Two real big cities, Omsk last night and Novo-Nicolaievsk this morning. The larger Siberian towns so far are, however, like repetitions of one and the same, all situated on a low rise to the east of a big river, while low grounds stretch towards the west; and also in composition—a number of churches with their bright-colored domes, some larger brick structures, a few brick and cement houses, and the great rest all small log- or frame-dwellings, each with its little barn and chicken coop and a yard-garden, set along wide, long, straight streets mostly green with grass. At Omsk hundreds of cows seen browsing along these streets—each family has one or two. They were sent out to pasture over the day, and were now returning to be milked. . . .

Immigrants are seen at every station and in their trains often strong, grizzly, shaggy figures; and placards at stations announce that "in the Primorskaia gubernia there are still 81,000 freeholds for distribution, in the Zabaikalskaia over 60,000," etc. Saw similar trains in my former visit to Russia, and pass one or more every day of this journey. The migrants are mostly whole families, with all their belongings tied up in bags; occasionally they even bring grain or flour. They are steadily peopling Siberia, and there could scarcely be a better stock for that purpose. . . .

The journey is nearing its end—at 7 to-morrow morning will be at Krasnoyarsk, and then the real doings will begin. Wish I knew the language as a native so I could pass freely and understand everything, and then to have sufficient time to see all of importance.

May yet give up the return by Europe, for here I am at the mine of knowledge and here is the true workshop for me. Want to reach the human sources here, for every glimpse of the natives makes me feel more and more strongly that near here somewhere must also have been the sources of the American aborigines. . . .

The day ends in country every part of which is interesting. A huge empire of fifty years hence. No winter will keep people from such lands, and who knows what lies beneath them? How different this from the Siberia of one's preconceptions!

July 19. On the Yenisei River. Bound for Minusinsk, on a wood-burning small old-fashioned river boat—three and a half days' journey. On the fine, beautiful, great Yenisei, of which the natives sing. My presence here almost like a dream, and by forgetting a little the surroundings and the absence of man's evidence it would be like on the Hudson where this passes above West Point through the lower hills.

Yesterday awoke amidst green moderate elevations and depressions, and soon after that the train reached Krasnoyarsk—a fairly big village-town stretched over a low flat terrace, on the left bank of the great stream—a terrace about four miles in length and formed once by the river. The place is really just a great village which here and there begins to turn into a city. Went with the engineer friend and put up at a frame hotel with big rooms, good possibilities, but furnished without taste and neglected like some of the frontier places in our country. There are two other hotels in town, one better but dear, the other, judging from outside, worse than this. . . .

The day was warm and I spent it in going about trying to find people, see Museum, get tickets for boat, visit the lunch-room. By ten at night, after many miles of walking and with feet almost sore in the heavy shoes, have seen everybody I wanted and was ready to go to

sleep—but not so other people in the hotel, who kept going about, talking, etc., I do not know how long. Had I not done such a day's work I surely would have had but little sleep, but as it was rested anyway, noise or no noise. In the morning, however, everything was asleep—at 8:30 not even a little coffee ready. Asked for my bill—"the paper was locked in." As I could not wait, the domestic, the only one about, began to write it on a half torn sheet with some advertisement on the other side and began to put down, as usual here, candles, which I never used, bed-clothes, to which I objected, and of course the room. With the help of my friend, who fortunately just appeared, succeeded in reducing the bill to what was reasonable and in having it written on a decent piece of paper. . . . Such places have I presume but common demands, the owners are not rich, and they have no experience of better conditions. They will disappear in the natural course of things.

At 9:15 on the boat, a sort of a ferry about 120 feet long. Could get no more of the very limited first- or second-class accommodations yesterday, so took a whole "cabin" third—fortunate that such was obtainable. As it is shall be more comfortable than I would have been in the second or first class with one to three companions; only there is no water to wash with in the cabin. The center of the boat, a good-sized space, is filled with the "muzhiks," their wives, children, bags, boxes, etc. The only provisions for these people are numerous flat benches, standing so that barely enough space is left for approach to the cabins—or more fitly "closets." On these benches they soon have their "padushky" (pillows), and blankets of all sorts, and before long a good many are lying down and sleeping, men, women, children, side by side, in all positions, packed almost like sardines. But still more come later on, stepping over and among those already on the floor, looking for a bit of space

for themselves; yet there is no altercation, no disorder, no sign of any distress—all seem to have plenty to eat—there is no drink, except some “kvas” (weakly alcoholic nourishing drink made by fermenting stale black bread)—and all appear contented.

The day is hazy, somewhat cloudy, but luminous, warm. My cabin measures 4' x 6', is 9' in height, and has a window from which I can look westward. The only furniture is a little table-shelf in the free corner, a wooden bench for a lower and a plank for an upper berth, and on my bench a grass-filled mattress with a clean unbleached linen cover; also little folding carpet chair, and a small rack on opposite wall for hand baggage. If there was another passenger it surely would be close but as it is it suffices, and I like the simplicity, the more so as all is quite clean and without any traces of insects.

Some wait before departure. As I had no breakfast yet, the first thing I do is to order “chai” (tea), and they bring it to me in a little pot which sits over a larger pot of hot water. One can drink the tea, which is good but not strong, and then add water and drink again, and so on to many editions; and that is the way the people here do it.

Make an acquaintance—a doctor and amateur naturalist from Tomsk; but he speaks the Russian so much worse than others, and is so much less apt at understanding what I say, that to be with him is more of labor than pleasure. However, much better than no one.

Go to top deck or rather roof. There are a number of benches along the sides and I take the foremost, where I leave everybody behind. The air is peaceful and pleasant. The fine, mighty Yenisei, as broad here as the Hudson at New York, with fresh-green islands, stretches before us to the steel railroad bridge and thence into the hills. On the left, the east, rises a continued range of high green hills with spruce woods, and there

are in spots lanes of brown-black freshly tilled soil and green lanes of grain fields on the slopes. To the right on a long bench about sixty feet high above the present level of the river is the village city, and farther on as well as behind mount finely green hills. There are as yet no quays here, no docks, only the natural shore of gravel. Boys are fishing from this, and once in a long while get a little silvery fish about three inches long. A man and again a girl come to the river and drink with their hands, regardless of impurities—but there are as yet no sewers opening here and so there is no special danger. The town, which has nearly sixty thousand inhabitants, has no sewers yet, as it has no car line and so many other things. A short distance from the floating boat wharf is a raft, very simple, for the washer-women, and it is full. They beat the tougher wash with wooden ladles as in old southern Europe and use no soap, but the water here is very soft. A soldier bathes a horse, farther on are two small bathing houses for men and women, and some clumsy rowboats made on the style of single log dugouts, which doubtless were their prototypes. What a chance here for a first-class bathing place and an array of nice rowboats, little sailboats, launches of our kind. But there are plainly so many chances in Siberia. . . .

A ferry swings across the broad stream by an ingenious device without any power of its own. It is tied to a line which is fastened also to half a dozen of boats, the first of which is firmly anchored in the middle of the stream, the others stretching along the line at a distance from each other; and this arrangement, which sustains the long tow-line above the water, together with the current and the rudder, carries the ferry whenever needed between the town and an island, perhaps a thousand feet distant.

Our boat starts a little after 10 A.M. It runs well, only slow. It pulls a



A YOUNG COLLECTIVE FARMER OF KHAKASSIA, SIBERIA
READING A KHAKASS NEWSPAPER TO A NINETY YEAR-OLD FRIEND.



SPASSKA BRAVA—THE MAIN TOWER AND ENTRANCE OF THE KREMLIN WHICH FACES THE RED SQUARE AND IS SLIGHTLY BELOW THE CATHEDRAL OF ST. BASIL. ALONG THE WALL TO THE RIGHT ARE BURIED MANY OF THE VICTIMS OF THE REVOLUTION. THERE, ALSO, IS THE TOMB OF LENIN, FROM THE TOP OF WHICH STALIN AND THE REST OF THE MEMBERS OF THE SOVIET GOVERNMENT REVIEW ARMY AND PHYSICAL CULTURE PARADES.

freight barge and will stop at every landing along the river. A fairly stiff breeze now blowing on the water, but the temperature is agreeable. Pass under the R. R. bridge, a huge iron structure, and on the east shore take on a lot more passengers. I thought the boat was already full, but there came probably forty others, and with what baggage! Boxes, small trunks, bags, an odd wheel for a wagon, sled-runners, bread tub and other things; yet they all get in somehow or other and that without disorder, and take their places on the ground and in all corners. They are not allowed to bring their things onto the top deck or that too would be turned into a "lager," but otherwise they can go wherever they want; there are no restrictions.

Pass picturesque rafts with wood, and later others with piled-up sacks of flour, or with hay, even with a load of cows and horses. Two men, or four, occasionally a woman among them, with big heavy oars, work alternately now in

front and now behind, two at one oar. There is a dog, a sheltered bench to sleep on and a pile of sand on the top of which is kept fire—people and a life of their own, as on all big rivers.

We stop near one such raft fastened to the shore, and one of our muzhiks or "chelovieks" (a human being), as they call them here, commences at once to inquire of the man on the raft where from, and how much does bran sell at his place, and how is the "chleb" (grain) there this season. Pity I can not yet follow everything. It is provoking to see a child of four or five talking the language so well and here I can not. And then come almost angry thoughts as to when shall the people of the world be evolved enough to adopt but one language, carry it to perfection and get rid of this and many other serious barriers to human progress. But that will be near the millennium, not in our time, and meanwhile half of man's life and effort must be spent in struggling against im-

pediments which he is unable as yet to overcome. He is still a victim of his defects and the mastering of these is so slow, so very slow and difficult. . . .

Notice that on shore most of the people wear black gauze about their heads and necks—this am told not so much against mosquitoes as against swarms of little flies and gnats.

It has now become rather windy on the river but not unbearable, and I keep my seat. Accidentally come across a newspaper notice that "there has arrived, at Krasnoyarsk, the Director of the Psychological-Anthropological Museum at Washington, Prof. Ales Gerlin"—which, it dawns on me, must mean myself. They have no H in their language, and the rest was just massacred. . . .

From what I see of the people, but few even here are of the more southern Slav type. Nearly all grizzly, in all shades, and the heads and faces rather oblong than rounded. They work very well and rest very thoroughly; and eat and eat, when they have. Women smoke cigarets which they make themselves, as

do the men, but both moderately. Many pitted from smallpox, but nearly all have good sets of teeth, and one sees no weaklings or deformities. Marks of poverty, but not as repugnant as elsewhere; and have seen yet no beggars here. . . .

The river is growing in beauty, the hills and slopes on both sides are live green and very pleasing. All is as fresh as new. My friend, the naturalist from Tomsk, comes and tells me enthusiastically of a wonderful discovery of his at Tomsk—a new frog. Lived there fifteen years, searching for amphibia, etc., but always went out one way from the town. Then once he thought he would go the other way. So went and, in returning towards evening, heard in a swamp a peculiar something with a very strong voice, which he took at first for a bird. On closer investigation, however, found the sound to proceed from the edge of the marsh, so approached carefully, located the sound, and pounced on the animal, taking it regardless of wetting—and found a new species of a big bull-frog, related to the American. And all told so delightfully naively. . . .

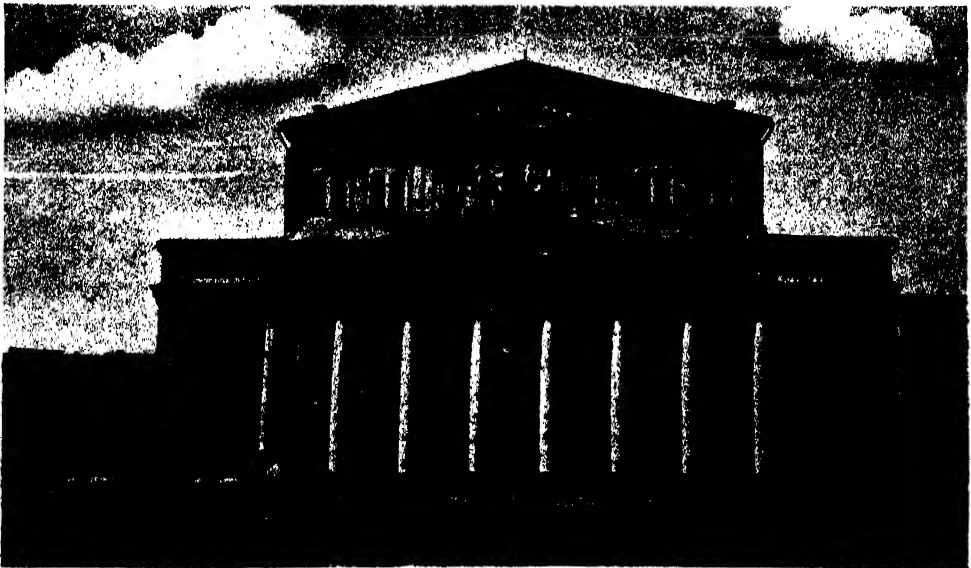

THE BOLSHOI THEATER OF MOSCOW
WHICH WAS DAMAGED BY THE GERMANS IN THE RECENT SIEGE OF THAT CITY.

The Yenisei water here is just a little muddy, of much the same color and swiftness as the Potomac when there were no heavy rains; and the bed has now become somewhat narrower. There are low flats covered with sapling birches; there are cliffs and slopes from which brownish rocks protrude like the ruins of walls or towers; there are woods and greens where the eye involuntarily looks for deer or a bear perhaps; and only once in a very long while is there any sign of human beings.

"Dinner" from 1 to 5, and nothing after that except to order. Good "borsheh" or red cabbage soup with a hard-boiled egg, a piece of meat and sour cream, all in one, very nourishing and by no means disagreeable; a fine piece of fresh sturgeon, good rye bread and the inevitable tea. Am able to save a good portion for supper, as do others.

Rocky cliffs to right with dark caverns. And a little later a "dierevna" (village), exactly like those in Russia. Plenty of children, an abundance of them everywhere. A group of men and women in a birch thicket on shore sing to us as we pass, agreeably, "to make us feel good." There are some wooden huts built into the shore, front of logs, roof earth and sod. A smaller affluent from the left—scenery now as primitive as that in the Sierras in Mexico. On right high steep rocky slopes continue. Meet a little boat with a square dark sail—does not look very trustworthy. A low sandy bluff with hundreds of holes in it—homes of swallows. And at the upper end of the bank, in a gully, a small stream and a log-house with a primitive mill.

Now we near a lone church with two nice blue-green bulging little domes, in the birch forest on the left, and a small chapel not far from the shore. It is a pilgrim place, where the travelers of the river may linger a little in the peace and beauty of it all, and say a prayer. As we come nearer the church bell gives a few sounds, some of the pravoslavny priests

with curious hats and long hair are coming down from the church to the chapel, one with a collection box takes his place at the steps which lead onto the small low flat from the river, and our boat sides into the raft which is rigged up here for the landing. The boatmen call "half-an-hour's stop." The chapel is opened, about three fourths of those from the boat go in, buy and light candles, hear some charmingly sung litanies in the characteristic deep Russian voices, then gather daisies on the greens about and stragglingly return. The priests now take a position on the bank and as the boat departs sing a final lovely majestic choral, and bless all with a large metal cross. I too went and listened, and felt good, and brought a daisy. How beautiful all this was, thus far out of the world. Submission under such an enchanting form bears something deeply instinctive and happy, and is proper to man, who is so dependent on the great known and the still far greater unknown. Priests served, pilgrims prayed, and all were chastened and strengthened. So, stranger, do not belittle, do not begrudge, but partake fully and give freely, and you too will be consoled. Could only all chapels, and priests, be such. . . .

The cliffs to the right now show rock broken up in vertical seams. And as we pass on we come, 50 versts above Krasnoyarsk, on the right shore, to limestone bluffs full of large deep caves, the "Birusi" caverns—a highly promising spot for exploration. There are but two small primitive limekilns around, and as most of the caves look inaccessible they presumably have not yet been despoiled. (Had one of them explored later by a friend from Warsaw.)

As the cave-cliffs are passed twilight is on. Have my little supper, with lots of weak tea. Engage in some conversation or rather listen to some with now and then a question, about Minusinsk. That is said to be a town of about sixteen thousand, and if the hotel at Krasno-



THE VALLEY OF THE UDA RIVER IN EASTERN SIBERIA
THIS IS ONE OF THE MOST POPULAR VACATION REGIONS FOR SOVIET TOURISTS AND ALPINISTS.



OLD-FASHIONED RUSSIAN FARMER



RUSSIAN GIRL FROM UKRANIA
TEEMING WITH HEALTH AND GOOD NATURE.

yarsk was bad that at Minusinsk is, I am assured, worse. Well, need not be there forever. . . .

When I come to my little cabin and ask the boy about bed, the pillow, sheets, cover—am told there are none and I ought to have brought my own. However, after some ado the boy lends me his own-pillow, hunts up somewhere a clean case for it, sells me for two rubles a new sheet of good unbleached linen, and I go to sleep. But the cover is too small; so it occurs to me that I have a piece of red cloth with me which I carry for a background in photography. It is just large enough and so, by about 11 or half past, after chasing some fleas, fall sweetly asleep. Had a day to a satisfaction.

About 1 A.M. am aroused by unearthly noises of wood thrown on board, and this keeps up for an hour. They are loading the boat with fuel, bringing a pile after pile of the big splits on two poles and throwing them on the floor about the boiler. That no one can sleep with such a noise is evidently quite equanimous to those who conduct this, for they make not the least effort to diminish the crashes, and pay no attention to any one. Well, the only thing to do is to console oneself that nothing lasts eternally. It did stop at last, and then I slept with vengeance till half past seven. . . .

July 20. To-day, Saturday, the scenery has changed, the hills are lower, less green and less beautiful, the exposures of the rock show horizontal stratification, and camps of gold-washers have begun. The country is growing more populated, several small villages are passed, located as a rule on the flat banks of the river. Stop here and there, women bring milk, five kopecks (2½ cents) a quart or a liter bottle; black bread, ten kopecks a round loaf of three to four pounds weight; eggs; some of the half-ripe nevertheless sweetish strawber-

ries, currants; very thick sour cream in earthen jars; and even a piece of butter. Then a man brings a pail of kvas, the fermented sourish not unpleasant drink made from stale black bread, and sells a kopeck a drink, that is a ladle. Everything is bought by the passengers, the milk especially, though not without much effort to reduce the price a kopeck or two on the part of the buyers. But all goes on good-naturedly and all are satisfied in the end, except one or two stingy ones who wanted the bread another kopeck cheaper so long till all was gone and they were left without any. But the others will surely sell them a portion. Have not seen such a bargaining since somewhere in the Old World in my boyhood. . . .

The meals are as yesterday. No one comes to do my bed, so I do it myself; it takes but little exertion. Look for the bothersome fleas, but they are not to be seen; anyway they do not yet bite me, just run and jump over the body. . . .

At 3 P.M. another stop of an hour for loading wood—they seem to want enough for the rest of the journey. All go picking strawberries, I also—they are small and not many, but good. Some of the muzhiks buy a live sturgeon, in a minute have an iron pot over a fire on the beach and the fish is cooking, while they form a brotherly group about and wait for their supper. No one minds me or stares at me. If only I could speak their language properly, some of them seem full of knowledge and love of these regions.

The river now meanders and divides between flats and among low islands, the hills in the background coming but here and there to one or the other bank as if to take a look at the stream. The day is warm but bearable, the sky keeps hazy.

The second night passed better than the first, one stop only at midnight; the noise of the anchor awoke me, but there was no loading. Am quite comfortable under my "compound" bedding, and with the fresh air, enough to eat and

plenty to learn, see and think of, am very contented. . . .

The hills have changed, show reddish dark or light green sides, gulleys, corrugations, and are now barren of trees or only sparsely and partly covered. The rich alluvial flats and islands along and in the river just cry for the plough, or at least the scythe, or cattle, but their time has not yet arrived. . . .

Needed to shave, but there was no looking glass and I was unable to impro-

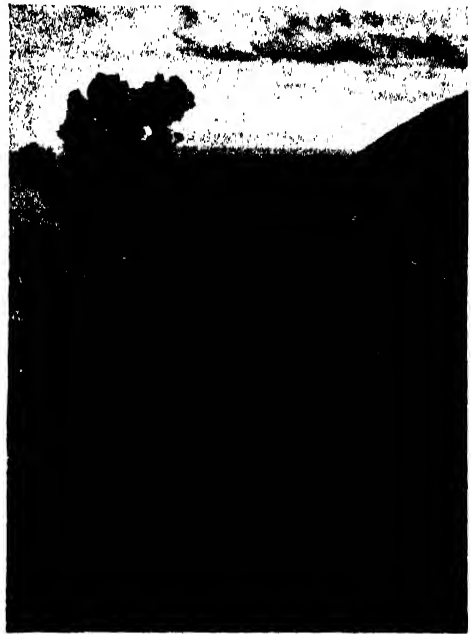

LAKE BAIKAL IN SIBERIA

vise any; so called again on the boy, my efficient provider, and he brought me a fragment of one, about 4 inches long by 2 broad; I stuck it behind a card with rules on the wall, and all went fine. The simple life for "sarten."

As I came out from my cabin saw a muzhik who had just washed his whiskered face in a pail of the river water and was wiping it slowly with his coat. Then saw a deck-hand who also washed, but following just shook the water off like a big dog and left the rest to dry.

The boat itself is kept clean and free

from smells and is in general very well managed. Met another such going down the stream named "Sokol" (ours is "Nicolai")—like a friendly neighbor—exchanged greetings. . . .

The weather is again fairly warm and the sky hazy, clouded. The river is still quite large, and in places swift. Curiously there are no water-fowl—but that is probably because of the season. There are also no fish jumping and no one at our stops now tries to fish, nor are there any nets or fishing boats to be seen, so the water here at this time of the year is probably not rich in fish. Also have seen as yet no trace of mollusks of any kind. And there is no smell to the yellowish-greenish and nearly clear water, such as given off by the Potomac and other rivers. . . .

The Sunday passes on mildly and, as usual, one would not know it except by the calendar. There are the same stops and loadings of wood, the same good-natured marketings and bargainings for one, two, three kopecks as on other days,

and there are no Sunday costumes or observances. The hills now grow again higher but nuder, and we are slowly coming to a drier region. Great flats made formerly by the river, and similar islands, lie unutilized—the best earth and easy of irrigation, if needed, but not yet needed enough. . . .

It is now windy and cooler, the muzhiks have put on their overcoats—we are getting higher and nearer the great southern mountains. There is a good deal of humor in these homely men and women on board, but they are never noisy. Drink, strangely, is almost absent. Have seen just two bottles of beer on this whole journey, and there has not yet been the slightest quarrel or disorder.

My friend of the frog fame makes me acquainted with two or three other passengers. One this evening. Used to be a soldier at Kronstadt and now in the service of the steamboat company. Was glad to answer all I could ask—I do not dare yet speak very much—and then went on telling me and telling me, of



A POSTMAN HANDING MAIL TO A YOUNG COLLECTIVE FARMER
ELEVEN NEWSPAPERS ARE PUBLISHED IN KHAKASSIA. POSTMEN DAILY DELIVER LETTERS AND
NEWSPAPERS TO THE REMOTEST CORNERS OF THE LAND.

what I shall never fully know, but it was some part of the universal complaint against the government and especially the officials. One can not approach closely any one without soon hearing some of the same story. But I was glad he talked, for what still sounds largely like the bubbling of a brook little by little is becoming more intelligible. I would like so much to know well this expressive and, when spoken well, especially by a fine woman, a really beautiful language. Have accidentally heard two such on the river promenade at Krasnoyarsk, and followed them as close as I dared just for the treat of it. They were young, but I never even saw fully their faces. . . .

It is now nearing 10 P.M.—near noon in Washington, almost at antipodes. The last night on the boat—where and how will I sleep to-morrow? But what matters? Am clean and well, have made a journey of near 500 versts on one of the great Siberian rivers, and there is a whole new creation before me where I go. . . .

Have come now into a region of semi-arid plains and mountains, and into one of old burial places. The latter are marked with more or less high and upright stone slabs, which we see in some places from the boat. The captain says that on clear days one can already see from here the snow-clad peaks of Mongolia; but it is again hazy and half-cloudy. On the west they point out to us coal mines, said to contain millions of tons of good coal; and farther south, the engineer tells me, is a mountain of asbestos, large deposits of marble, and other native riches, waiting till Siberia gets ready. . . .

July 21. Had another wood loading at 1 A.M. with the usual results, but now, there being no more wood, they keep on; at 2 P.M. are to arrive at Minusinsk. Will see the Museum, natives and the old burial grounds of the region. . . .

Now that this little idyllic journey is nearing its end I become conscious that I shall be sorry to part with all this company which has become a sort of a big family. Yesterday a nice, middle-aged, well-educated lady began to talk to me, and before the evening we were like old friends. She told me much about hers and wanted to know of mine, and it was all so kindly and genuine, ending with cordial invitations to visit her Tobolsk family. . . .

Minusinsk is the southernmost town in these parts of Siberia. It lies in a vast alluvial grassy plain beyond which looms a chain of forbidding snow-clad mountains, the Sayan range of western Mongolia. It is a nice, not very compact frontier city, and surprised me by its astonishingly rich and well-arranged Museum. The vast plains about it with their rich soil will once be a region "of milk and honey." But they are interesting also in other ways. Disseminated over them, especially in the northwestern direction, towards Atehinsk, are hundreds of old native "kladbishche" or cemeteries, marked by their more or less leaning tall stone-slab monuments. They date from the bronze to early historic periods and contain the remains of countless nomads whose flocks and occasionally armies roamed over these plains. It was from these regions doubtless that Genghis Khan recruited much of his strength. Remnants of the old population still live on the Abakan River, where I went to see them and where with the aid of a young Russian I obtained many photographs; and the whole country is full of promise archeologically. . . .

The few days spent in the district passed rapidly, were followed by a much quicker return to Krasnoyarsk, whence I took the first good train to Verchni Udinsk—a regular frontierstown—then another long trip on the Selenga River to Khiakhta, and from there a wonderful trip to Mongolia.

(To be continued)

STREAMLINING THE SOVIET WATERWAYS

By Dr. W. O. BLANCHARD

PROFESSOR OF GEOGRAPHY, UNIVERSITY OF ILLINOIS

For a country so vast, so compact and so lacking in open ports, Russia has been dependent to an extraordinary degree upon *inland* transport. Yet, until a decade ago, the ordinary facilities for such haulage—the roads, the railways and the waterways—were notoriously poor. As a consequence long distance movement of either goods or peoples was negligible and local communities had to be self-sufficing to an extraordinary degree. Not until the First Five Year Plan was inaugurated in 1928-29 was the nation's transportation system scheduled for a thorough overhauling—a job long overdue!

Highways Few and Poor. Of all the country's commercial facilities, the highways have been found most wanting. The United States had, in proportion to area, about twenty times the mileage of Russia. Actually the disparity was even greater than this ratio suggests, for many of the Soviet rural "roads" were mere trails across the country, unimproved in any fashion, unfenced, not even graded! They were distinguished only as parallel wheel tracks in the dirt. Naturally they were passable only during extended fair weather. It was not unusual for villages to be cut off from the outside world for from two to six months at a time when prolonged rains or spring thaws made travel impossible.

Inadequate Railroads. Although they had long been the main dependence of the country's transportation system, the railway facilities had also lagged far behind the needs of the nation. They were lacking in mileage, in equipment and in efficient operation. Here again the United States, in proportion to the area, has about twenty times as much

main trackage. Much of the Soviet mileage was originally laid without careful planning, while many lines were built with an eye chiefly to their strategic importance. Equipment was mostly purchased in western Europe, where short hauls were the rule. Small cars, hand-operated brakes, light rails and engines, poor bridges and inadequate ballast—all in a bad state of repair—this was the sorry picture of the Soviet railways in 1928.

Waterways Poorly Developed. The inadequacy of roads and railroads had for long served to emphasize the importance of water carriage. Yet, on the whole, that service was about as backward as the others. Little effort had been made to dredge the streams, equip fleets or build terminals to handle the traffic. Even the most elementary port equipment was lacking. In the half century ending in 1910 expenditures for railways were seventy-five times as much as for river and canal improvements. Steamers were used on only one fourth of the navigable streams, and canals or canalized rivers made up less than 1 per cent. of the total mileage of rivers suitable for navigation or timber floating. The traffic was not only small, but in recent years it was declining rapidly. Thus, from 1913 to 1936 it decreased by two thirds! Under the Czars the tonnage moved on all the rivers combined was very little more than that carried by the Rhine River alone.

Natural Handicaps to Water Transportation. Superficially, Soviet rivers would seem to be well suited for navigation. Actually, in their natural state, they leave much to be desired, and their modernization has been anything but

easy. While they have ranked *second* to the railways in traffic the waterways have certainly ranked *first* as a headache for the commissar in charge of communications.

The fact that the country is a vast plain is, of course, advantageous in rendering streams navigable. However, the *extreme* flatness of the terrain leads to

poor drainage—to vast areas of marsh, ponds and shallow lakes as well as to a dearth of stone for construction works.

The climate offers still more serious handicaps both as regards temperature and precipitation. In the extreme north the rivers are frozen for about six months; in the south, for at least two months. Likewise the highly seasonal

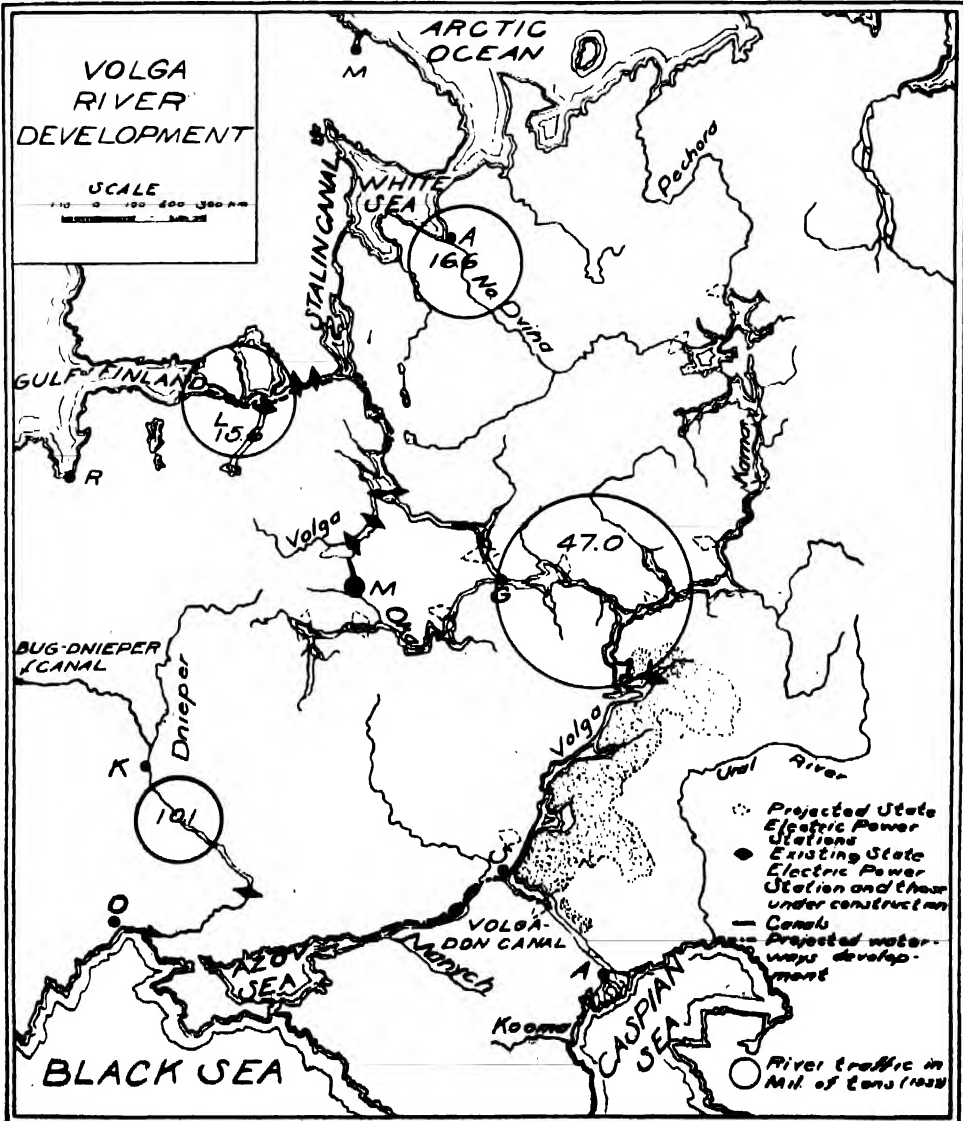

FIG. 1. INTERIOR WATERWAY SYSTEMS

character of the precipitation and thawing results in alternate periods of flood and low water.

Finally, the limited commercial importance of the coastal waters restricts the usefulness of their tributary rivers as links in the foreign trade routes. Practically all the coasts are ice-bound at least part of the year. In addition the Baltic and Black Seas can be and, at times, have been, easily blocked by foreign powers, while the Caspian is, of course, an *inland* sea.

It should be noted, however, that waterways transportation is favored by the bulky nature of the freight to be moved. Timber, oil and grain are of this type, the first mentioned accounting for over one half of the total water-borne tonnage.

General Character of the Volga. The Volga is Europe's longest river, and with its tributaries it offers a navigable length of some 7,000 miles. The entire drainage basin of about half a million square miles is the home of 50 million people. Including water extensions, completed or in the course of building, it reaches from the Baltic-White to the Caspian-Aral-Black Seas, from the land of furs to the land of cotton.

The Volga in many respects resembles our own Mississippi. The two are practically the same length. Both rise in marshy areas at comparatively low elevations. Both wind leisurely across vast interior plains without notable interruptions by falls or rapids—in fact, their average gradients are almost identical, about three inches to the mile. Both discharge through vast deltas. Both suffer greatly from the scourge common to most rivers—a widely fluctuating volume, with the usual accompaniment of migrating sandbars, snags and shifting channels. Mark Twain, as a Mississippi River pilot would have been quite at home on the Volga!

In a number of respects, however, the Russian river appears at a decided dis-

advantage. Its watershed is about half as large and the total volume of precipitation is only one fourth as great as the Mississippi, so that part of its basin is practically desert. While both suffer from ice, the Soviet river is affected throughout its entire course. Still more serious, however, is the fact that the Russian waterway empties into an inland sea—not into the open ocean.

The Volga system plays the dominant role in Russia's interior waterway carriage (see Fig. 1), accounting for almost as much tonnage as all the others combined. The enormous extent of its navigable waters assures the existence somewhere in the system of all the major handicaps and the merits of the country's waterways.

The Upper Volga. Of the three major commercial weaknesses of the Upper Volga, low water in summer and ice in winter rank first. Almost as serious is the fact that without artificial connections the headwaters are "blind alleys." Finally, instead of serving the nation's capital city the river curves around it in a great bend, thus minimizing its usefulness to the great Moscow industrial region.

As a remedy for these defects, little could be done about the ice, but dams, completed or under construction, are designed to correct in considerable measure the fluctuations in volume.

The need for joining the headwaters with the northern sea coast was long ago recognized. As early as 1810 the connection was actually made by a series of canals and canalized rivers. Some 43 wooden locks were used and the water journey from Moscow to Leningrad required from one to two months. Present plans call for a complete modernization of this thoroughfare with depths about $2\frac{1}{2}$ times those of the old channel. This waterway joins the Volga at Rybinsk, where a great dam and reservoir have just been completed.

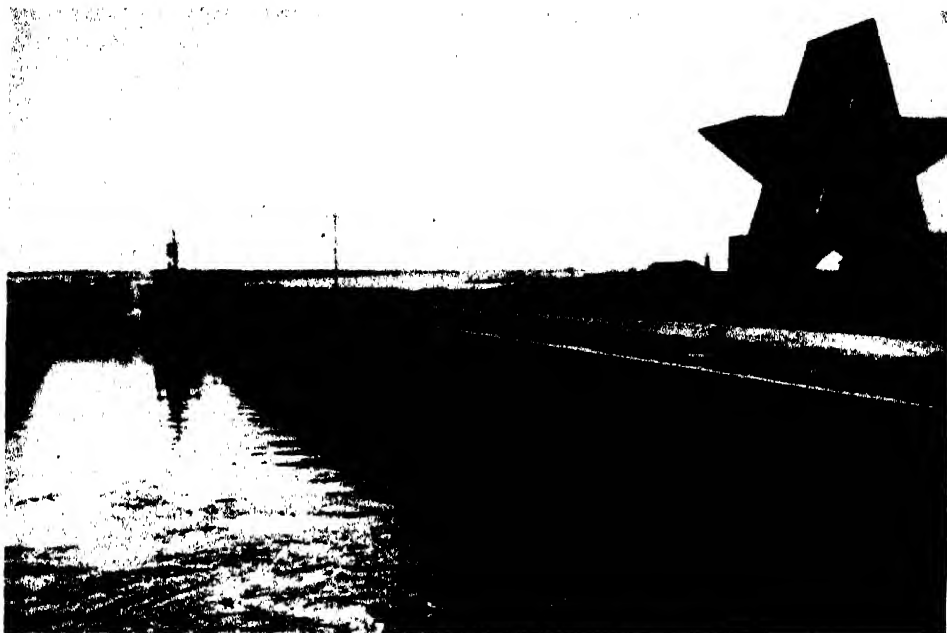

FIG. 2. THE STALIN CANAL WHERE IT JOINS THE WHITE SEA
THIS CANAL IS APPROXIMATELY THIRTY-SIX MILES LONG AND TWELVE FEET DEEP. ENERGY IS GENERATED AT FIVE HYDROELECTRIC STATIONS ALONG ITS COURSE.

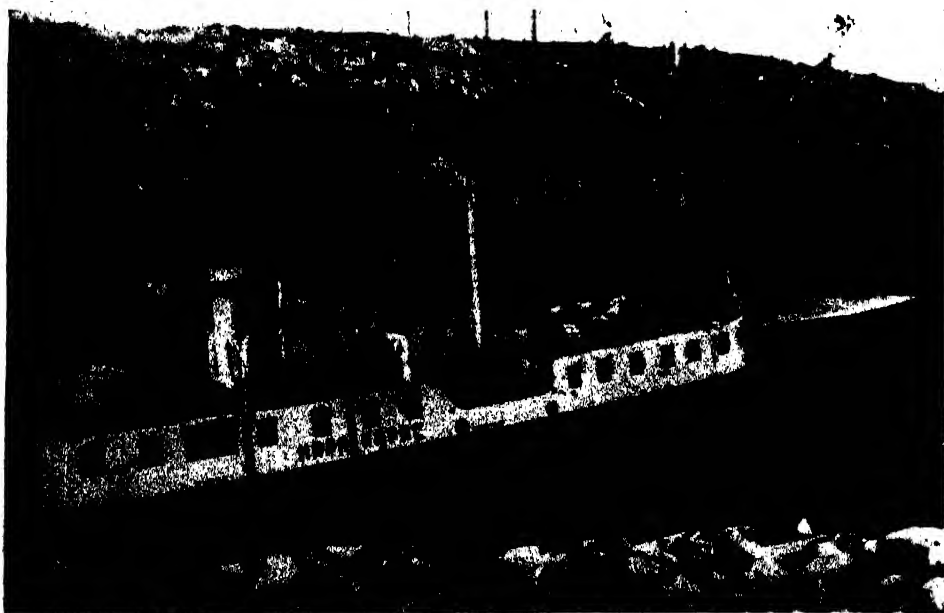

FIG. 3. THE STALIN CANAL CUTS THROUGH OLD GLACIATED ROCKS
IN NORTH RUSSIA. THE MAXIMUM ELEVATION OF THE CHANNEL IS 325 FEET; BOATS ARE RAISED AND LOWERED BY NINETEEN WOODEN LOCKS.

This link between the Baltic and Volga will also give access to the White Sea and Arctic Ocean by means of the Stalin Canal, recently completed. This latter, between Lake Onega and the White Sea, in some 36 miles long and 12 feet deep (See Fig. 2). It cuts through a low plateau of ancient rocks—the European counterpart of the Laurentian Plateau of North America (see Fig. 3). The channel reaches a maximum elevation of 325 feet, the boats being raised and lowered by 19 wooden locks. Waterpower is generated at 5 hydroelectric stations. The energy will be used for the chemical, metallurgical and lumber industries. The waterway will tap the supplies of granite, timber, fish (from Barents Sea) and coal (from the Pechora Field).

It will be noted on the map, Fig. 1, that the Upper Dnieper has now been joined with the Bug-Vistula, so the Black Sea as well as the Caspian will have direct water connections with the Baltic.

The third objective—bringing the Volga to Moscow—has also been attained. The capital city is located on the Moscow River, a small tributary of the Oka, which in turn is a major branch of the Volga. Commercially the Moscow River was of little value. Fluctuations of depth were extreme. Three fourths of the whole year's discharge has been known to pass in a single month, so that in late summer it was too shallow to use. Railroads handled forty times as much of the Moscow traffic as did the river. Furthermore, Moscow drank over one half of the river's discharge, and at the present rate of growth the city would, about five years hence, consume it all. Under the Czars less than one half of Moscow's buildings had water connections and only one fourth were provided with sewer connections.

By constructing a dam across the Upper Volga north of Moscow, the impounded water has been diverted south

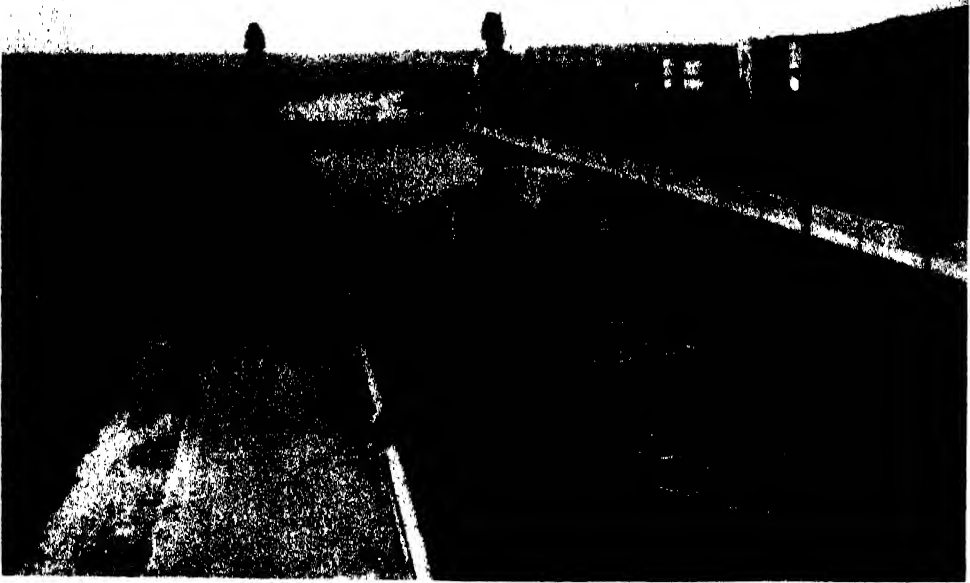

FIG. 4. A SCENE ALONG THE MOSCOW-VOLGA CANAL SYSTEM SINCE THIS PROJECT WAS COMPLETED THREE YEARS AGO, RIVER FREIGHT HAS AMOUNTED TO ALMOST FOUR MILLION TONS AND MOSCOW IS FURNISHED WITH AN ADEQUATE WATER SUPPLY.

into the Moscow River channel, thence into the Oka and finally back into the middle Volga at Gorki. Five huge hydroelectric stations raise the water over the intervening divide. In the three years since the completion of this project the river freight has amounted to three and three-fourth million tons, and the city has at last been able to enjoy an adequate water supply (see Fig. 4).

The Lower Volga. Like the Upper Volga, the lower section also suffers from three major handicaps to transportation. They are (1) insufficient water, (2) a vast delta and (3) lack of access to the open sea.

Scant precipitation and excessive evaporation, combined with a lack of tributaries, work a hardship upon navigation on the lower Volga. Likewise, much of this drainage basin is steppe or desert—agriculturally, marginal land, except where irrigated. The remedy being ap-

plied is the construction of dams for better control of the waters. Incidentally, the hydroelectric power will be used largely for irrigation pumps. As shown on the map, Fig. 1, the right bank of the lower Volga is bordered by bluffs; the left bank is a low, broad flood plain inviting irrigation.

The delta offers a major problem. One of the distributaries had been canalized by dredging, but even so it has been too shallow for Caspian steamers. The level of the sea has been falling in recent years, greatly aggravating the difficulty. Caspian steamers, according to reports in 1940, were not able to get nearer than thirty-five miles of the delta canal.

The methods of shipping petroleum illustrate these inadequate facilities. Caspian tankers from Baku, some as large as 9,000 tons, go as close to the delta canal as possible and there unload into barges which are towed by tugs to



FIG. 5. CASPIAN STEPPE REGION SCENE BEFORE IRRIGATION
EXCEPT WHERE IRRIGATED, MUCH OF THIS DRAINAGE BASIN IS AGRICULTURALLY MARGINAL LAND DUE
TO LACK OF PRECIPITATION AND EXCESSIVE EVAPORATION.



FIG. 6. BAKU PETROLEUM WILL SOON BE ABLE TO REACH TIDEWATER VIA THE VOLGA-DON CANAL. NEAR THE DELTA CANAL CASPIAN TANKERS FROM BAKU HAVE TO UNLOAD THEIR PETROLEUM INTO BARGES WHICH ARE TOWED TO ASTRAKHAN.



FIG. 7. FROM STURGEON COMES CAVIAR—FAMOUS FOOD OF THE VOLGA. THE BEST CAVIAR, WHICH CAN ONLY BE MADE IN WINTER AND IS DIFFICULT TO PRESERVE, IS THE LOOSELY GRANULATEL KIND KNOWN IN RUSSIA AS *ikra*.

Astrakhan. There another transfer is made to river barges, which carry it upstream.

The land-locked Caspian is a blind alley and possesses but a poor hinterland. The solution proposed and now being carried out is the Volga-Don canal. At one place the Volga comes within 50 miles of the Don, and the proximity of the two streams has long suggested their union here. For navigation this will require 6 locks on the Don and the dredging of that river to its mouth. Three hydroelectric stations are involved. In addition to power and navigation the project is intended to help stabilize the Caspian level by directing part of the upper Don into it. Additional water for the shrinking Caspian will be obtained by damming the headwaters of several Arctic rivers, *e.g.*, the Pechora and North Dvina and directing the waters via the Kama-Volga to the Caspian (see Fig. 1).

Middle Volga Improvements. The rectification of the Middle Volga consists chiefly in building a number of dams making reservoirs arranged in a step-like series. These will regulate the volume and provide electric power and

irrigation water. The extremely gentle gradient—2.0 to 2.5 inches per mile—the lack of solid rock foundations for the great dams and the densely populated farm lands to be flooded are some of the major engineering problems involved.

Of the 15 dams proposed for the whole Volga the one at the great Samara Bend will create a lake of 2,900 square miles. The two hydroelectric stations here will have a capacity eight times the total electric power generated in all Russia in 1913 and it will have almost twice the capacity of the Grand Coulee—now the world's largest! Some 10,000,000 acres of desert and steppe north of the Caspian will be irrigated, the flow of the river will be regulated and 100 miles of river navigation eliminated (see Fig. 5).

At present Volga steamers must draw less than six and one-half feet, and at certain seasons they may go up stream as far as Tver. From that point to the mouth is 1,650 miles via water—a journey of months—but less than 900 miles in a straight line. At the end of the Third Five Year Plan a depth of 9 feet is promised from Moscow to Astrakhan, the same depth now provided from Chicago to the Gulf of Mexico.

FORESTS AND PEOPLE

By R. F. HAMMATT

ASSISTANT TO THE CHIEF, U. S. FOREST SERVICE

THE evidence of Eocene flora, made up of once-living trees, strongly refutes the hypothesis of continental drift since that geologic time.¹ There is, however, ample evidence that forests influence the drift of mankind and the welfare of nations, and that forests have been and are influenced by people.

This latter evidence goes back at least to the time when Uni—whose name appears on a historical text discovered by Mariette in the necropolis of Abydos—was “Inspector of the Woods of the Royal Domain of the Pharaoh Teti.” A later inscription records Rameses III, of the Twentieth Dynasty, as having “planted trees and shrubs to the end that the people should sit under their shade.”

The Old Testament refers to extensive forests that helped establish the maritime supremacy of an ancient Mediterranean civilization, but recent aerial views reveal a tragedy of land use near the Lebanon mountains. In “The Earth as Modified by Man,” George P. Marsh tells of forests that have disappeared, of vegetable earth and mold that have washed away and of rivers famous in history and song “that have shrunk to humble brooklets” in what was once the powerful and prosperous ancient Roman Empire.

The high forests of Corsica and Sardinia were bases for the sea power of the republics of Pisa and Genoa, just as the forested slopes confronting the eastern shores of the Adriatic Sea were for that of Venice. But in all three cases reckless forest exploitation was responsible in no

small part for the present economic poverty of the areas concerned.

As author of “Forests and Sea Power,” R. G. Albion makes the statement that influences of the shortage of timber in England when Cromwell ruled extended to many diverse fields. It was felt, he says, “not only in the Navy itself, but in international law, in naval architecture, and in England’s foreign, colonial, commercial, and forest policies as well.” Illustrating man’s influence on the forest, Pack and Gill in “Forests and Mankind” recall that once the sun never set on that magnificent tree we variously call tulip tree, tulip poplar, yellow poplar and white wood. It once grew, they say, in all parts of the globe, but “now there are only 2 species left, one in America and the other in far off China. From the rest of the world the tulip tree has vanished utterly.”

According to Raphael Zon² there are three broad but major stages in the relations of man to forests, and of forests to man. The first stage, he says, is the one in which the forests dominate civilizations; in the second, civilizations are overcoming the forest; while civilizations dominate the forest in the third stage.

Forests dominated, Dr. Zon points out, when they acted as barriers to the spread of the Hamites from north Africa southward. When they kept the Bahima from the Congo, and limited the eastward expansion of the Inca empire from the high plateaus of Peru and Bolivia. When, largely because of difficulties they imposed on travel, they served as political boundaries in the old world and the new.

¹ “Bearing of Forests on the Theory of Continental Drift,” by Dr. Ralph W. Chaney, in SCIENTIFIC MONTHLY for December, 1940.

² “Forests and Human Progress,” published in *The Geographical Review* for September, 1920.

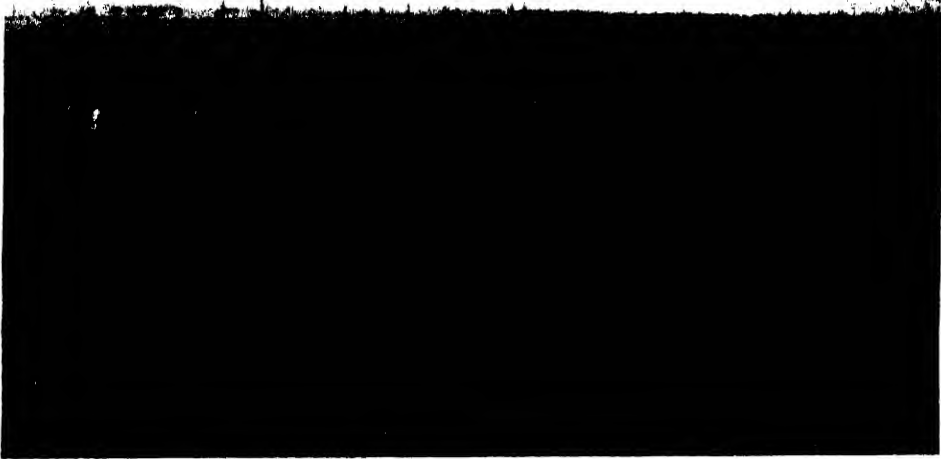

FOREST EXPLOITATION OF LONGLEAF PINE LAND IN MISSISSIPPI WHICH WAS CLEAR-CUT ABOUT FIFTEEN YEARS AGO. THE POLICY OF EXPLOITATION IS STILL PRACTICED BY MOST PRIVATE OWNERS OF FOREST LAND.



AN EXAMPLE OF GOOD FOREST MANAGEMENT BY A PRIVATE OWNER IN MISSISSIPPI WHO CUT FIFTY-EIGHT TREES PER ACRE BUT LEFT ON EACH ACRE THIRTY-FIVE TREES THAT WERE FIFTEEN INCHES AND OVER IN DIAMETER. (COMPARE WITH PHOTOGRAPH ABOVE.)

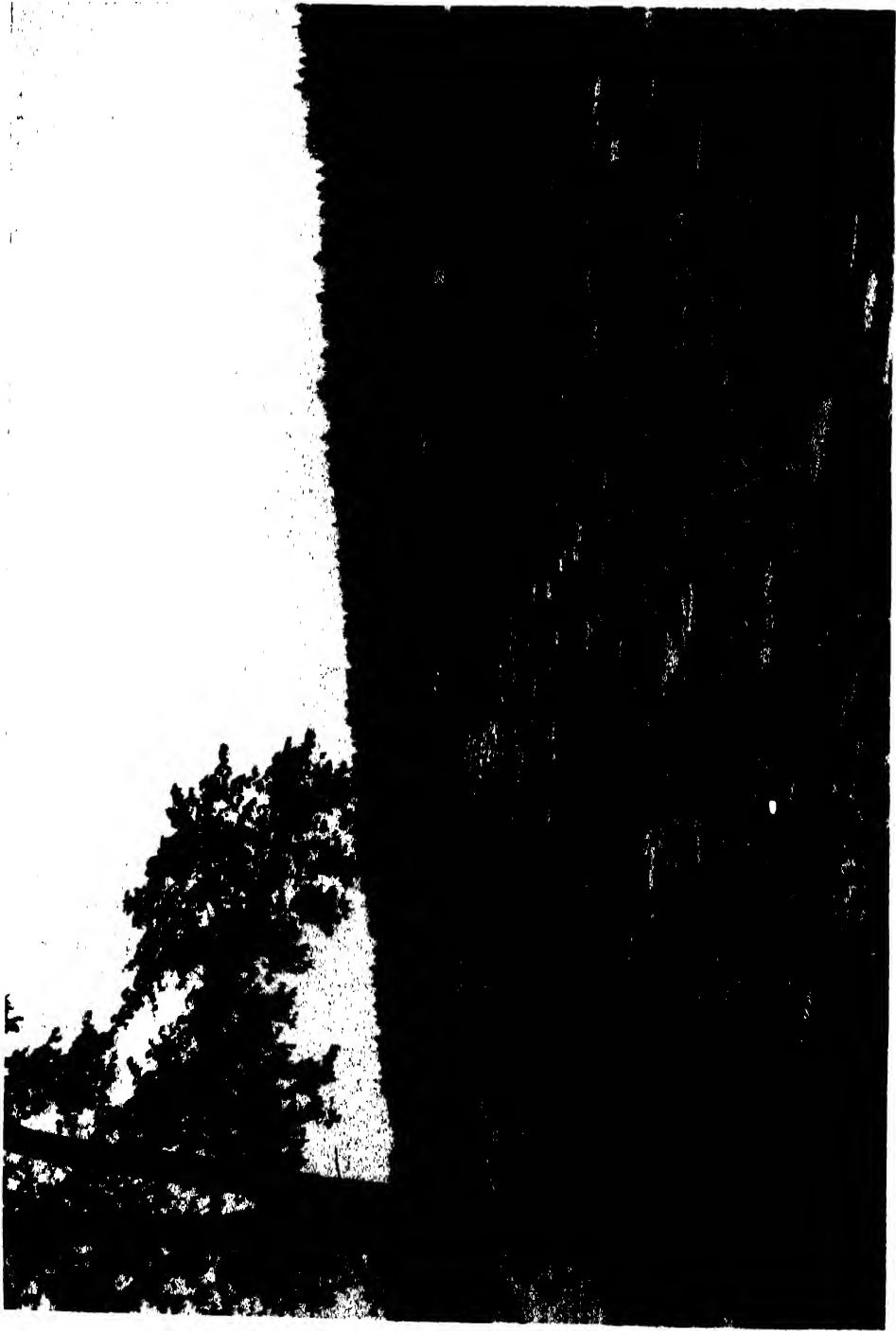

WATERWAYS HELPED MAN TO OVERCOME THE FORESTS
THE ANDROSCOGGIN RIVER FULL OF SPRUCE PULPWOOD BOLTS FROM NEAR THE WHITE MOUNTAIN NATIONAL FOREST, NEW HAMPSHIRE.

Although dominating civilizations in the first period, forests provided deer and other wild game, and helped shelter and defend mankind. Robin Hood in Sherwood Forest offers an illustration in point. Caesar's Commentaries have many references to the part forests played in the resistance of the Gauls to the Roman legions. Before the age of iron and steel British ships of the line had great masts that were cut in Maine, topmasts that had grown in the Ukraine, smaller spars from Norwegian mountainsides, planking that had floated down the Vistula, with curved frame timbers from Sussex oaks. And—although here we jump to Zon's second and third stages in the relations between men and forests—pioneers in our own naval stores industry drifted southward and westward as local timber was exhausted, then followed the longleaf pine all the way to the open plains of the Brazos. After which "the sons and the sons' sons of the original tar heels of the piney woods hitched up their mules . . . and returned to the Carolinas to start over again on the second growth forests . . . that a kindly creator had grown for them in their absence."³

Dr. Zon says that man was essentially a hunter when forests dominated; that European man began to dominate the forests when he started clearing them to make room for new plants that yielded more food; and that it was in this second stage that extensive clearings showed up in German forests.

It was not until Negroes had arrived along Central America's shores that forests were affected by the food motive there. Clearing of forests in southwestern France was begun by the Vandals some 1,500 years ago. With "not enough open space to establish a 40-acre farm"

³"Tar Heels of the Piney Woods," by I. F. Eldredge, published in *American Forests* for February, 1937.

in what Ernest Bruncken⁴ calls "the great Atlantic subdivision of North American forests," clearing there became a necessity soon after the first colonists arrived. And as their grim struggle continued, there developed a resourceful and dynamic backwoods type that, with roots sunk deep in familiar forests, charted the course of a new nation through the days of its youth.

Waterways and axes and fires helped man to overcome the forest. The Rhine offered a route along which extensive openings could be made in German forests. Without the Androscoggin, the Penobscot and other rivers, many a New England forest clearing would have been postponed. Without axes and fire, many American pioneers would have found it almost impossible to fell and then get rid of all the trees from clearings made for corn, and for a space to see the Indians before they could get close to the settlers' cabins.

Most early clearings in America were made to conquer and subdue the forest as a matter of necessity, but exploitation began as an eager, land-hungry people moved northwest and southwest, then west and ever west. This exploitation, and forest fires, spread and grew as railroads and falling saws supplemented rivers and axes; as steam instead of rivers made larger and faster sawmills possible; as ox teams gave way to donkey engines; and as gasoline—and then diesel—tractors and "cats" roamed the woods.

In outline, this was how our forests were overcome.

We have carved an empire out of a wilderness while dominating forests, and history is studded with references to the resourcefulness and ingenuity with which this has been done. But in the process the forests on privately owned

⁴"North American Forests and Forestry," published by the Knickerbocker Press, 1908.

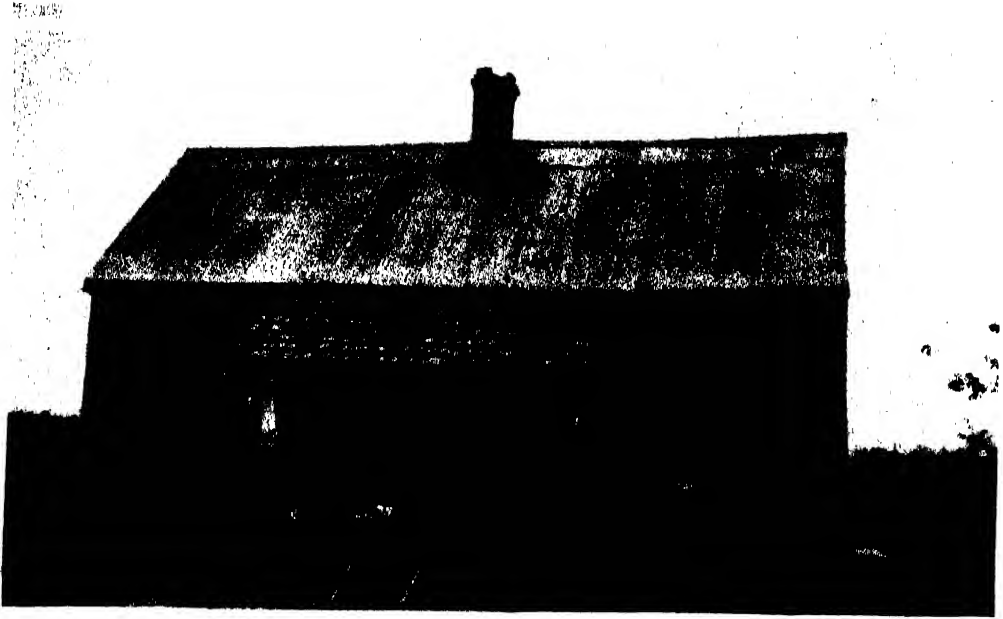

A HOUSE TYPICAL OF THE RURAL SLUMS

THIS DWELLING WAS INCLUDED IN THE FOREST SERVICE STUDY IN THE SUMTER NATIONAL FOREST IN SOUTH CAROLINA. FOREST EXPLOITATION IS LARGELY RESPONSIBLE FOR RURAL SLUMS.

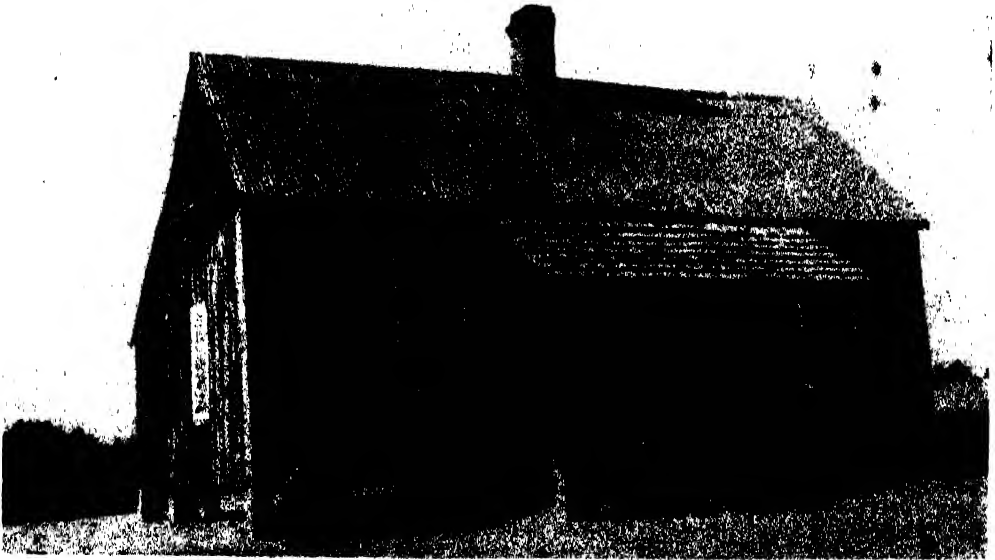

**REHABILITATION HELPS SOLVE SOCIAL PROBLEMS IN MANY RURAL SLUMS
THE PICTURE SHOWS SIMPLE BUT EFFECTIVE IMPROVEMENTS TO FOUNDATION, FRONT STEPS, WIN-
DOWS, CHIMNEY AND PAINT, AS COMPARED TO THE CONTRASTING PHOTOGRAPH.**

land—which makes up the best and the most accessible three fourths of all our commercially productive forest land and furnishes about 95 per cent. of the timber we use—have been cut so destructively for so many years that the forest resource as a whole has become widely and seriously crippled.

In the Northeast, including New England, for example, more than 2½ billion feet of lumber now has to come in yearly on ships and freight cars which might otherwise be used to transport food and guns and munitions. Our greatest reserve of virgin forests is in the Pacific Northwest. Yet in eastern Oregon and Washington the privately owned pine timber large enough to harvest will probably be exhausted in two decades or less at pre-war rates of cutting; in the Douglas fir region of western Washington there are only about 20 privately owned saw-timber holdings with enough big timber to last 10 years at 1940 cutting rates; some of western Oregon's counties have already been practically stripped of merchantable Douglas fir.

Drains in the South have been heavy and long continued. Three fourths of the forests there are now second growth, more than two thirds of all the merchantable pine is in trees less than 17 inches in diameter, and most forest land is growing only one third to one half the crop of wood it should grow. There were once vast virgin forests in the Lake States. The remaining privately owned spruce there is now being clear-cut or high-graded, only about 1.9 million acres of the privately owned hemlock and hardwood saw-timber forests remain uncut, and most of the Lake States land that originally bore big pines is covered with grass, bracken, aspen and scrub oak and pine.

Exploited and depleted forests are serious enough, but rural slum conditions—which destructive cutting on pri-

vate land, and other things, have helped in varying degrees to create—are more so. For until recently these slum conditions affected the lives and the outlook on life of 8 millions of farm people who for decades had been living under conditions involving shelter and diets so inadequate that poor health was general. This meant wide-spread inability to do a good day's work even if work were available. It meant high relief loads. And it meant young folk too many of whom were physically and temperamentally and educationally poorly equipped to function as future citizens of this or any other democracy.

Most of the worst of our rural slums occur within areas where the forest resource has been crippled but still offers what appears to be a major opportunity for sound social and economic rehabilitation. In itself this is a striking illustration of the need to keep all forest land continuously producing all the usable products and services it can produce.

Wood is one of these products. It is one of the world's most useful and valuable raw materials. It can be grown with less cultural effort than any other land crop. No other living product of the land can approach its flexibility as to time of harvest, or its capacity to accumulate stores of widely used basic raw materials like cellulose. Forage and water are other forest-land products. Grazed by domestic livestock, forage contributes to the meat, wool and leather that are needed in war and in peace, while water from forested slopes irrigates cultivated crops on millions of fertile acres.

One service of forests is the wages they make possible; wages that in the past have supported close to 13 million people yearly. Another service is recreational use. It is now big business. Well-managed forests help prevent erosion and conserve the soil on which all life de-



FOREST LANDS PROVIDE RECREATION IN A LAND OF MARVELOUS BEAUTY
AN ISLAND CAMP SITE ON LAKE INSULA, IN THE SUPERIOR NATIONAL FOREST, MINNESOTA.

pend. They also help minimize the height and frequency of floods, maintain the navigability of streams and harbors, and regulate water used for domestic purposes, for irrigation and for generating hydro-electric power.

Services like these rival timber growing in importance. They indicate what in "Farmers in a Changing World" Gove Hambridge calls "the increased awareness of the human aspects" of certain basic problems. They also clothe forest land with a public interest that, in the world of today, must of necessity take precedence over the interests of individuals or groups.

Private forest land—which is the best and most accessible three fourths of all our forest land—has always been dominated by destructive cutting, but the evidence is clear that in recent years an

increasing number of forward-looking industrial and other leaders, no longer content with fire protection, have also put worth-while cutting practices into effect on forest land they own.

This represents real progress. With certain developments on publicly owned and managed forest land, it affords added proof that destructive exploitation and deterioration of the forest are unnecessary even to help win the war. However, there is also evidence that progress still falls way short of maintaining that forest resource on which agriculture and labor as well as industry and commerce must depend to help cushion many critical post-war readjustments and win the peace.

According to recent annual and other reports of Dr. Earle H. Clapp, who has emphasized that all forest-land resources



**CROP GROWING IN THE LEE OF A SHELTERBELT
THAT IS PART OF THE 11,000 MILES OF LIVING WINDBREAKS PLANTED DURING THE LAST FIVE YEARS
BY THE FOREST SERVICE THROUGH ITS PRAIRIE STATE FORESTRY PROJECT.**

and services must of course be made available in such amounts and at such times as may be necessary to win the war, this evidence reveals in part:

That as late as 1940 there were more than 149 million acres of privately owned forest land that needed but did not get organized fire protection, and forest management of any kind was still lacking on close to 70 and 85 per cent. of the commercial forest land in farm and industrial ownership, respectively.

That even in 1936, a depression year in which production levels were low, all forest drain in both saw timber and cordwood stands was at a rate which, in relation to all usable forest growth, represented a net annual deficit of some 4 billion cubic feet of wood.

That in this, our first war year, destructive practices are still the rule when most privately owned forests are cut. *And*

That in this first year of war the combined cut of saw timber and cordwood bids fair to increase to a point where drain is 50 per cent. greater than all effective forest growth.

Dr. Clapp, who is acting chief of the Forest Service, has pointed out that it

seems unfair to try to put all the responsibility for these conditions on forest industries; that in his opinion the public is also responsible because of its indifference, and the Federal and State governments because they have allowed such conditions to continue. He has contended that the scope, character and diversity of the problems affecting most private owners of forest land, and the vital public interests inherent in this land and the services it and its resources perform, warrant and make essential the extension of public cooperation and aid to private owners by State and Federal Governments.

But the acting chief of the Forest Service has also pointed out that the time for temporizing—for depending entirely or even largely on public cooperation or on the initiative of private owners—has passed; that although we need both of them, the time has come for such other



SPECIAL PERMITS FOR FAMILY OCCUPANCY OF BUILDINGS LIKE THIS ONE IN A NATIONAL FOREST IN KENTUCKY ARE ISSUED BY THE FOREST SERVICE, AS THERE ARE MEANS TO REHABILITATE ONLY A SMALL FRACTION OF THE PLACES THAT NEED IT.

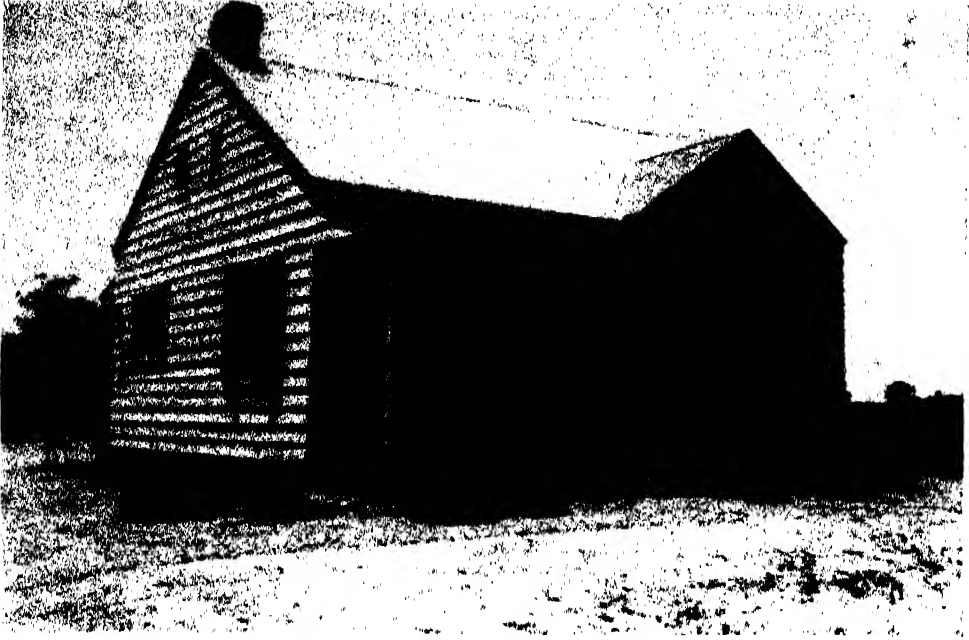

**HUMAN REHABILITATION AND FOREST REHABILITATION GO HAND IN HAND
ONE OF SIXTY-FOUR FARMSTEAD HOMES IN THE EXPERIMENTAL SUBLIMITY, KENTUCKY, FOREST
COMMUNITY BUILT BY THE FOREST SERVICE NEAR THE CUMBERLAND NATIONAL FOREST.**

measures as will assure the stopping of destructive cutting on private forest lands and the keeping of those lands at least reasonably productive. And positive assurance, he has said, lies in two measures and apparently only two: Nation-wide public regulation of cutting and other forest practices on private forest land, and public ownership and management of much more forest land.

Both these measures are included in a comprehensive forest program. This program, endorsed by the Department of Agriculture, has for its long range objective the establishing and maintaining of a nation-wide forest economy that will help solve problems of rural poverty and unemployment and create security and stability for families, industries, communities and regions that depend upon the forest resource.

In addition to public regulation the first part of this program—which is a

3-part one—includes public cooperation with and aid to private owners of forest land in such things as: Protecting their lands against fire, insects and diseases; retaining existing markets and uses for forest products, and finding new uses and new markets; helping forest owners to solve their problems; making public credits available to owners who are willing to give their forest holdings good management but who need credits to do it; and removing inequalities with respect to State and local property taxes on forest land.

The public ownership measure is in the second part of the program. It calls for extension of community, State and Federal ownership and management of forest land that is submarginal for productive use under private ownership, and forest land on which private owners can not or will not protect vital public interests. This measure contemplates the public



NATIONAL FOREST PONDEROSA PINE LANDS UNDER MANAGEMENT NEAR SENECA IN EASTERN OREGON. NOTE THE HEALTHY RESERVE STAND, WHICH WILL RESEED THE AREA, AND THE ABSENCE OF WIND THROW AND DEBRIS.



CLEAR CUTTING OF PRIVATELY OWNED PONDEROSA PINE LAND NEAR SENECA IN EASTERN OREGON. NOTE THE SPARSE RESERVE STAND, THE WIND THROW, DEBRIS AND THE ABSENCE OF REPRODUCTION. (COMPARE WITH PHOTOGRAPH ABOVE.)

acquisition of some 140 million to 150 million acres, with communities and States going as far as they will, but the leaving of more than one half of all commercially valuable forest land in private ownership.

This second part also recommends additional facilities for protecting, developing and using the existing national forests and their resources, plus such lands and resources as may be added to them, and for making the national forests still more outstanding demonstrations of public ownership, public administration and public service.

The third part of this 3-part nation-

especially Federal leadership in it—is new and revolutionary. They assert that it disregards the Bill of Rights. They characterize it as bureaucracy run wild. Let's forget it, they urge, and concentrate on winning the war.

Many people doubt the new and revolutionary part of this view-point. Professor P. L. Buttrick may be one of them, for in his "Backgrounds, Methods, and Problems of Public Regulation of Private Forests"⁵ he holds that "the very nature of forests is such that public interest in them . . . has existed from time immemorial, and their control has long been a governmental function." Also

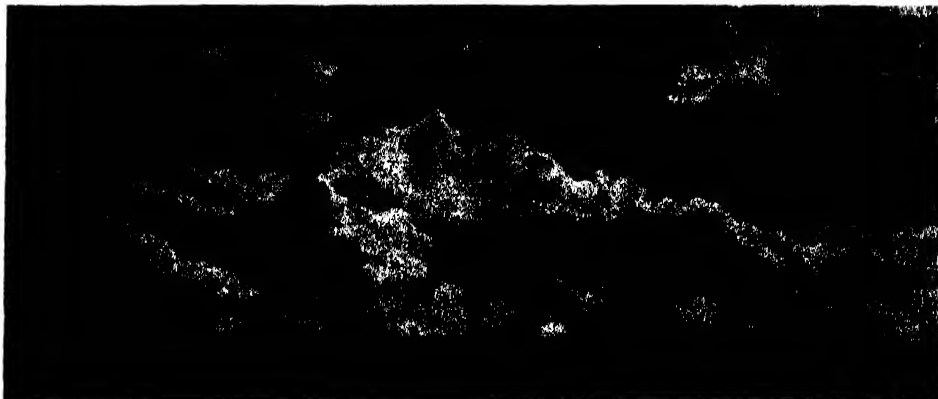

A MEXICAN RETURNING HOME WITH FIREWOOD
GATHERED IN THE GILA, NEW MEXICO, NATIONAL FOREST.

wide action program has to do with more adequate provision for research for both private and public forest lands, their resources, the services—such as watershed protection, outdoor recreation and wildlife conservation—that forests render, and the social and economic problems involved.

Most industrial and other private owners of forest land enthusiastically endorse the public aid and public research parts of what is known as the Forest Service program. But many of these owners strongly oppose the public regulation part. They claim that it, and

that the system of forest rights established in Medieval times "recognized [the forest] as a public utility . . . laid the basis for existence of public forests, and later led to the development of modern methods of public management regulation designed to keep all forests productive."

There seems to be doubt, too, if nationwide public regulation of private forest land, with Federal participation in it, would disregard the Bill of Rights. For the fifth amendment to the Constitution provides, in part, that "no person shall

⁵ *Journal of Forestry* for March, 1941.

be . . . deprived of life, liberty, or property without due process of law," and under the public regulation as proposed all aggrieved forest owners are assured of having controversial matters decided by that due process of law if recourse to the courts becomes necessary. Moreover, the power to regulate interstate and foreign commerce, *including navigation which is often seriously impaired through erosion and siltation induced by forest devastation*, is delegated to the Congress by Section 8, Article 1, of the Constitution.

There is always danger that bureaucracy may run wild, and we must always guard against this danger. It is therefore fortunate that, in theory at least, most of us are "agin" control of what we think of as the rights of the individual and property rights. But since most of us are also practical, we demand regulation when safety to children as they cross

automobile-crowded streets on their way to and from school is at stake; when our families need protection against communicable diseases; when we invoke city or rural zoning or land-use ordinances or State hunting or fishing laws; and when, as a nation, we are threatened by economic or military aggression, or both. For we realize that we as individuals can not do these jobs; that public regulation in many fields is essential to the broad public welfare and fits into the now-accepted framework of the American way of life.

Long before what happened at Pearl Harbor on December 7, last, hundreds of millions of feet of lumber were going into prosaic war-time needs like cantonments, defense housing, factories, ships and docks, while increasing quantities of wood or pulpwood or constituents of wood were being used in the making of more warlike-sounding products such as



NEGRO WORKERS OF THE PINEY WOODS
HARVESTING FOR TURPENTINE AND ROSIN ON THE OSCEOLA NATIONAL FOREST IN FLORIDA.

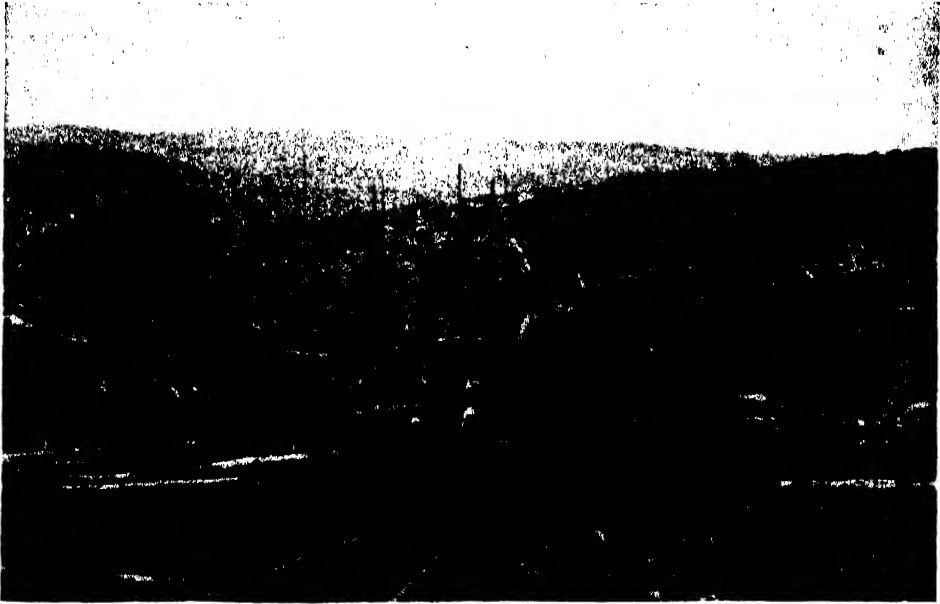

ONCE A VIRGIN STAND OF TIMBER GREW ON THIS OREGON LAND THAT IS NOW A "DOUGLAS FIR DESERT" AS A RESULT OF CLEAR CUTTING IN 1924, WHICH WAS FOLLOWED BY FIRES IN 1925, 1929 AND 1933.

nitroglycerin and gas masks and dynamite and flame-throwers.

The production of lumber and pulpwood that will be needed during our first war year bids fair to exceed 1936-40 five-year production averages by close to 35 and 70 per cent., respectively. These 1942 levels represent perhaps a greater impact on forest lands than the impact of agricultural goals on farm lands. Under cutting and other woods practices that are still wide-spread on privately owned forest land, they represent destructive exploitation that has been accelerated by the war but is not necessary to help win it. And these practices are still further depleting and crippling a resource the products and services of which are vital to the everyday lives of a people at peace.

Perhaps this explains, in part at least, why the Secretary of Agriculture has

said⁶ that we need "and we need now" some form of adequate public regulation of forest practices; why he has expressed the conviction that failure to protect and rehabilitate our forests "would be comparable to tearing down our defense factories, girder by girder, to get steel for munitions"; and why in his message of January 7, 1942, the President reminded Congress that "It is a part of our war effort . . . to conserve our natural resources and keep in repair our national plant."

Perhaps all this illustrates as well as explains, in part at least, the attitude now gaining headway with respect to forests and people; the attitude characterized by a "lest we forget" motif rather than by the "let's forget" one previously mentioned.

⁶ "Forests and Defense," released for publication by the Department of Agriculture.

THE NATURE OF WAR AND THE MYTH OF NATURE

By Dr. M. F. ASHLEY MONTAGU

ASSOCIATE PROFESSOR OF ANATOMY, HAHNEMANN MEDICAL COLLEGE AND HOSPITAL, PHILADELPHIA

IT is now seventy years since that fatal morning when a dust-laden young Prussian officer galloped into Paris at the head of a small advance party of Uhlans, thus signalizing the capitulation of the French and the unequivocal victory of the Prussians. Forty years later this self-same Prussian officer, now a general, careered into Europe with a book which at once attained a universal notoriety. That book was entitled "Germany and the Next War." It is hardly an exaggeration to say that no book of a similar nature had before, nor has any book since, been so fervidly and widely discussed. In England, at any rate, the book passed through more than a score of impressions in as many weeks. As a child, then living in London, I well remember the sensation it caused, and how often I saw it in the most unexpected places. Since those days I have learned that the volume used to be kept on tap in the precincts of those lesser parliaments, the pubs, where those who "talked politics" could freely consult it over a tumbler of beer or a pipe. In this book the author, General von Bernhardi, boldly threw down the gauntlet to the world, and virtually with sabre in hand called upon the German people to protest against "the aspirations for peace which seem to dominate our age and threaten to poison the soul of the German people." It is understandably rather hard for an iron-headed soldier, after some forty years of comparative inactivity, to recall an event so stirring as the entry at the head of a victorious army into a defeated enemy's capital, without feeling that if things were not

actually going to the dogs it was, at least, high time that something were done to prevent the possibility. And so in order to convince the German people of the "unnaturalness" of that "inactivity which saps the blood from a nation's sinews," von Bernhardi did something that he had never done before; he wrote and published a book, making the pen, as it were temporarily, do service for the sword, and ink for blood. "War," declared von Bernhardi, "is a biological necessity"; it "is as necessary as the struggle of the elements in Nature"; it "gives a biologically just decision, since its decisions rest on the very nature of things." "The whole idea of arbitration represents a presumptuous encroachment on the natural laws of development," for "what is right is decided by the arbitration of war." In proof whereof such notions of Darwin's as "The struggle for existence," "natural selection" and "survival of the fittest" are invoked with a sententiousness inversely proportional to its sense. According to von Bernhardi, it is plainly evident to any one who makes a study of plant and animal life that "war is a universal law of Nature."¹

This declaration and fortification of Germany's will-to-war—for it had the highest official sanction and approval—was published in 1911. Three years later the greatest holocaust the world has ever known was launched upon its ghastly way by those

¹"Germany and the Next War," Popular Edition, 16th Impression, pp. 14, 16, 20, 23-24, 30, 34.

vultures sick for battle

Those bloodless wolves whose dry throats rattle,
Those crows perched on the murrained cattle,
Those vipers tangled into one,

the inhuman, militaristic Bernhardis, the legislators of a victimized Europe.

The Great War came to an end twenty-two years ago, having cost the lives of thirteen million men, eight million of whom were slaughtered upon the field of battle, and ten million civilians, who died either directly or indirectly as a result of the war. As for the maimed and wounded combatants, these amounted to a mere twenty million. The cost of running this fracas amounted to \$125,000,000 a day during the first three years, and \$224,000,000 during 1918, the total cost of the killing amounting to some four hundred billion dollars.

This year considerably more than the total income of the governments of the world will be spent on armaments. The war that has for the last ten years appeared inevitable has already been with us for two years, and although there is hardly a human being now living, with the exception of the militarists, who can see either sense, good or anything but misery in war, my revered friend and teacher, Sir Arthur Keith, continues to aver in several recent articles² that war has its biological justification. Sir Arthur Keith maintains that the impulses which lead men to aggressive and defensive wars are "Nature's mechanisms for preserving the individual and the tribe or nation," and "which make individuals and nations willing to risk life itself to further the means and opportunities of life."

Sir Arthur Keith's opinions upon this subject first came into prominence with the publication of his Rectorial Address to the students of Aberdeen University in 1931, published in the same year under the title "The Place of Prejudice

² *The Truth Seeker*, N. Y., March, 1939; *Sunday Express*, London, 27 August, 1939; and *Man*, London, April, 1940, pp. 61-62.

in Modern Civilization." These opinions he has recently reaffirmed. In the present article I propose to take Sir Arthur Keith's views on the nature of war and, treating them as representative of the views of the biological-nature-of-war school, subject them to a brief critical examination.

Keith begins by declaring his firm conviction that "prejudices are inborn; are part of the birthright of every child." These prejudices "have been grafted in our natures for a special purpose—an evolutionary purpose." "They are essential parts of the evolutionary machinery which Nature employed throughout eons of time to secure the separation of man into permanent groups and thus to attain production of new and improved races of Mankind." "Nature endowed her tribal teams with this spirit of antagonism for her own purposes. It has come down to us and creeps out from our modern life in many shapes, as national rivalries and jealousies and as racial hatreds. The modern name for this spirit of antagonism is race-prejudice." "Race prejudice, I believe," continues Keith, "works for the ultimate good of Mankind and must be given a recognised place in all our efforts to obtain natural justice for the world." And now for the passage which has gained such wide-spread notoriety:

Without competition Mankind can never progress; the price of progress is competition. Nay, race-prejudice and, what is the same thing, national antagonism, have to be purchased, not with gold, but with life. Nature throughout the past has demanded that a people who seeks independence as well as peace can obtain these privileges only in one way—by being prepared to sacrifice their blood to secure them. Nature keeps her orchard healthy by pruning; war is her pruning-hook. We can not dispense with her services. This harsh and repugnant forecast of man's future is wrung from me. The future of my dreams is a warless world.³

Essentially similar views were expressed³ "The Place of Prejudice in Modern Civilization," New York, 1931.

pressed by Sir Arthur Keith in his Robert Boyle Lecture, "Nationality and Race" (1919). Now, unlike von Bernhardt, Sir Arthur Keith is a physical anthropologist of the first rank, and, as I well know, a man of the noblest and most generous nature; nevertheless, in his treatment of the subject of prejudice and war the fact is unfortunately betrayed that he has overstepped the frontiers of his own particular field,—to which he has made such lasting and classical contributions,—with results, to say the least, that are not altogether happy. Charles Singer has well said that "Even professional men of science, when they pass beyond the frontiers of their own special studies, usually exhibit no more balanced judgment or unprejudiced outlook than do non-scientific men of comparable social and educational standing." Sir Arthur Keith's Rectorial Address may be taken as a case in point.

What, we may ask to begin with, is this *Nature*, always, it is to be observed, spelled with a capital *N*? Keith's *Nature* is apparently a very intelligent affair, working things out purposefully and with much premeditated thought. I use the term *intelligent* here in a general sense to cover the operations of what is conventionally known as the *intellect*. It would seem, however, that an intellect which can conceive of no better device to improve its breed than by warfare must be a very poor intellect indeed. For surely the biological vitality of a species can be preserved and improved by a large variety of immeasurably more effective means than this; means which do not necessitate or require the annihilation of a single individual. But what, indeed, is this *Nature* of von Bernhardt and Keith which, according to them, makes war a biological necessity? Apparently it is anthropomorphism akin to the *elan-vital* of Bergson or the life-force of Shaw. In other words, it is God with the capital *G* in

very much the old form, divested here and there of a few sacraments, and perfectly clean-shaven, but otherwise much the same. Voltaire's jibe that if God had made men after his own image they had returned the compliment, is as appropriate a truth to-day as it ever was. *Nature* or God to-day is an anthropologist as well as a mathematical-physicist, sometimes an entelechist, and often enough merely a set of differential equations, unlimitedly limited and with an infinite number of functions at one and the same time, but if the truth were really known, merely a set of conditioned reflexes! In fact *Nature* may mean anything according to the whim of the user. *Nature*, says Aristotle, makes some men slaves and others free; by *Nature*, retorts Cicero, all men are free. In *Nature*, says Hobbes, "the life of man is solitary, poor, nasty, brutish, and short"; it is a condition of "war of every man against every man," in which "the notions of right and wrong, justice and injustice have no place," and "force and fraud are the two cardinal virtues." "The state all men are naturally in," replies Locke, is "a state of perfect freedom to order their actions . . . as they think fit, within the bounds of the law of nature. . . . a state of equality." "*Nature*," writes Wordsworth, "to me was all in all, she never did betray the heart that loved her." "*Nature*," rejoins Tennyson, "red in tooth and claw, shrieks against the creed of man." And as Professor Pollard has remarked of these antinomies, "Some see red, others see God, it all depends upon the kingdom that is within them." In effect, *Nature* is the name we give to the projection of the totality of our ignorance concerning the forces which are conceived to be responsible for the generation of life and its maintenance. *Nature* is not a "thing-in-itself" which operates upon other things; the term denotes rather, if it denotes anything at all, an artificial con-

struct, the purpose of which is to serve as a general stereotype for our ignorance, in addition to serving as a *deus ex machina* to which, in a quandary, we may appeal in order to be comfortably relieved of our perplexities. For most people to say that a thing is Natural explains it. But does it? What do we mean by Natural? Prejudices are natural according to Keith and others, poetry according to M. Jourdain, warfare according to von Bernhardi, and the golden lie according to Plato and some of his modern successors. Nature, it is said, is the universe of things as made or produced. Nature, it is added further, operates according to definite laws. All, in fact, is determined by law. The movements of the planets are determined by laws as immutable as those which determine the behavior of a dog or a man.

But all this is mythical.

The universe, as far as we know, is composed of a system of ever-changing *relations*, in the form, for example, of gases, stresses, forces, strains, velocities, dimensions, substances, and so on, truly *ad infinitum*. Nothing in it is fixed, all is flux. Between certain limits of infinity, that is, in a given space-time continuum, the relations of certain planetary velocities, for example, may remain (relatively) constant; the recurring averages in which these relations manifest themselves may be calculated to a high degree of probability, and when so calculated may be stated as laws. These laws are always probability laws and are valid only as long as the relations of the planetary velocities, as well as numerous other factors, remain (relatively) constant; should, however, any of these relations change, the old law will have to undergo modification, or an entirely new one will have to be elaborated.

With this in mind we may proceed further. A unicellular organism living at the bottom of a stagnant pool and environed by a stable universe of stimuli

will tend to undergo little change as long as the constancy of those stimuli persist, but modify its relations, the form and nature of the stimuli acting upon it, alter its environment, and if you go on long enough, say for a few thousand million years, sufficiently and adequately varying the nature of the environmental stimuli, not to mention the inherent tendency of the organism to vary, you will, let us suppose, produce a man. And your man, as an organism, will obviously represent the sum of the effects of the responses to the environment organically made by his ancestors. Organically your man will be the product of an innumerable variety of conditions—the changing relations collectively termed *heredity* and *environment*. So will, and so indeed is, any plant or any other form of animal life. Thus, all plant and animal life is not *produced* according to definite laws but in response to a series of arbitrary or *chance* alterations in the relations of the factors affecting it. Nature is thus not an intelligent teleologically directed process which acts according to predetermined law, but is a composite of chance relations which may be arbitrarily observed as unit-groups of recurring averages of relations, the behavior of the independent variables, or the quanta, of which being both indeterminate and unpredictable, whence the *principle of indeterminacy*. Man, indeed, owes his present supremacy to just such a series of indetermined chance relations, which may more briefly be described as an accident of accidents, the accident referred to having been initiated in the early Miocene epoch approximately some fifty million years ago, when owing, most probably, to the denudation of the forests due to causes which at present remain speculative, a number of chimpanzee-gorilla like creatures, resembling the extinct ape known to paleontologists as *Sivapithecus sivalensis*, were forced down from the trees

and were constrained to assume a life upon the ground, this revolutionary change in their immediate environment leading ultimately to the development of all those physical characteristics which we have learned to recognize as distinctive of man. Those apes who lived in the unaffected regions stayed up in the trees and therefore still remain apes. Was there any directive, telic, intelligent natural force at work here? Not at all. A devastating series of environmental changes accidentally precipitated may have been responsible for the descent from the trees. The colossal number of varied forms of life, extinct and living, that are to be found upon this earth to-day have arisen owing to very similar causes. Every form of life with which we are acquainted is due, or rather, owes its peculiar form, to the infinite number of changes that have been and are in progress of taking place in the environment peculiar to each—the internal as well as the external environment—these changes are not regulated by law but by chance. The processes of the universe of life are discontinuous and infinitely variable. The universe consists of an infinitely changing series of relations. Action and reaction, stimulus and response, take place always *relatively*, never *absolutely*. Nature, in short, in the determined immutable sense of the traditionalists does not exist, save as a procrustean fiction.

The law and order that man sees in Nature he introduces there, a fact of which he seems to have grown quite unconscious. Natural systems of classification work so well, that, following an unconscious pragmatic principle they are assumed to be true, or at least, representative of the truth, the latter being conventionally defined as correspondence with the reality of whatsoever it may be; in this way the tacit assumption is made that one has but to seek and one will find the law and order that is un-

doubtedly there in Nature. This process is termed *discovery*.

Now, while systems of classification are of incalculable value in aiding the processes of understanding and discovery, such systems are none the less quite artificial and do not in any way reflect a law and order which characterizes the operations of the processes we commonly ascribe to Nature itself. Nature is a fiction which uses neither measuring-rod nor time-table. It is man alone who uses such instruments in order that he may the more fittingly orient himself in relation to this self-created fiction. The classificatory systems of man are *fictional devices*, and represent merely the attempt—and it is a grand attempt—to unravel the tangled skein of some of the relations of the various forms of life and substance to one another, but no more. But of this man loses sight, and confuses himself with the belief that the law and order which he has worked out into an arbitrary scheme is that law and order according to which Nature works. *Homo additus Naturae*, remarked Bacon long ago. Nature, if it consists of anything represents a series of discontinuous processes, a complex of entangled gossamer strands, which man attempts to gather together and spin into a web which he naïvely imagines is the *real thing*, the real thing being merely as he sees it; and he sees it in an infinite number of ways, according to the kingdom that is within him. Nature comes in this way to mean anything; and what may mean anything, in fact means nothing. Nature is a term without definite meaning. Logically the conception of it is without the slightest value; psychologically perhaps, the term may not be without some significance in the sense of Nietzsche's words in "The Joyful Wisdom": "Laws and laws of nature are the remains of mythological dreaming."

With respect to the "war of Nature"

which is alleged to be a "universal law of Nature," that, it must be said, is pure fancy. We are told that even trees and flowers "fight." Do they? There is not the slightest evidence that they do. And if they do, what connection has this "fighting" with the warfare practised by men? Some flowers digest insects; some plants "strangle" others. Does this constitute war between the flowers and the insects concerned? Do the plants that strangle others have to plead guilty to murder? Are these "warlike" actions of plants and flowers advance or rearguard actions? It would be extremely helpful to know whether it is defensive or offensive war that is natural. Sir Arthur Keith believes that both are. The illegitimate use of such terms as *struggle*, *fighting*, *force*, and so on, when applied to plant and animal life, and the deliberate confusion of these terms with *war*, is too often made and far too often allowed to pass unchallenged. I cannot resist quoting Professor Pollard in this connection, who entertainingly remarks of this confusion:

The sun and the moon, we suppose, declare war with great regularity because they get into opposition every month. Parties in the House of Commons are perpetually at war because they are opposed. The police wage war because they are a force; for *naturally* if we use force against a criminal, we must needs make war upon other communities. War, indeed, will last for ever, because men will never "cease to struggle." So the League of Nations has obviously failed whenever a stern parent is caught chastising a peccant child; and "fighting" will go on without end because drowning men will fight for life, doctors will fight disease, and women will fight for places at drapery sales. And this is war!⁴

The case could not be put more neatly.

Man, like other creatures, kills a large number of animals for food and various other uses. Does the process of killing and consuming these animals constitute war? In any case, is the killing of those animals either necessary or *Natural*? It is neither innate in the psychophysical

structure of man, nor necessary in order that he may live, to kill any animal whatsoever, or plant, for the matter of that; at least not for men living in the highly civilized centers of the Western World. Man's taste in food is culturally determined, like his taste in cigarettes or alcohol. In primitive conditions of life he is forced to kill animals for food and apparel, just as it was *natural* a short time ago to kill prisoners of war in order that the food supply might not unnecessarily be depleted. Animals in the wild state kill large numbers and varieties of other animals, where they are available, for the satisfaction of their hunger, for the very good reason that they have no other means of remaining alive—but *man* has. Man has improved upon the wild ways of life of the beasts of the jungle, and there is not the slightest reason why he should revert to them. In medieval England it was considered natural and perfectly legal for all claims to real property to be settled and tried by battle; since then man has developed more peaceful means of settling such claims, not by blood but by reason, by virtue of an understanding made possible by a more enlightened form of culture. For culture, if it means anything, represents the fact of man's ability to elaborate and improve upon the normal processes of the Universe, commonly called Nature; in a very real sense to elaborate and improve upon his original endowment; and indeed to-day through means purely cultural man is in a position to control and regulate, in every possible respect, his own future evolution. He holds the power within himself of total self-extermination or more complete development, and it is by the weakness or strength of his intellect alone that either the one or the other effect will eventually be brought about. Fundamentally, man is quite an intelligent animal, but he is a victim, alas, of the two-handed engine of his culture which distorts his mind and renders

⁴ Vincula, London, 1925.

him unintelligent. Outworn traditional teachings have made of Western man a shockingly unintelligent creature who lives under the continuous and unrelieved domination of a chaos of ideas more degrading, more stupid, more idiotic and more saddening than it may ever be possible to describe. This confused morality has, without question, been substantially responsible for his present deplorable state, for the reflexes and patterns of thought of every child born into the Western World to-day have been conditioned according to the prescriptions of these teachings, so that culturally Western man has come to be a function almost entirely of the reigning spirit of confusion and prejudice. And since in his conduct he functions without effort as a victim of confusion and prejudice, he arrives at the belief that it is thus *natural* to act and to think. In this way is produced the mentally and spiritually bludgeoned individual who gropes his way confusedly through life—and whose number is legion. It is in his world alone that to-day war still remains a legitimate and defensible means of settling a dispute or forcing an issue.

With respect to Keith's "race-prejudice" that, of course, is a purely acquired sentiment, a constellation of socially manufactured emotions, as he would undoubtedly have known had he made as deep a study of cultural as he has of physical anthropology. Nature according to him secures the separation of man into permanent groups by means of the operation of race prejudices, which express themselves as natural rivalries and jealousies, in order to produce "new and improved races of mankind." This, we suppose, is a form of natural selection operating upon psychological bases, a form of selection peculiar to man alone, for no other animal, as far as we know, exhibits the slightest symptom of anything akin to what Sir Arthur Keith calls "race prejudice." So-called race preju-

dice among lower animals, like their so-called natural fears and terrors, are *acquired* not inborn. Experiments on young animals first carried out by Benjamin Kidd many years ago, and by numerous investigators since, conclusively prove that the "instinctive" fear and terror of their allegedly natural enemies exhibited by the adult members of the species, are emotions which are generally completely absent in the young, and that they are acquired only by *learning* from other members of the species, or by individual experience. A lamb or any other animal, for example, which has had no long association with members of its own species from whom it could have acquired the fear—or past experience with lions, will exhibit not the slightest fear of a lion when confronted with one.

No animal or human is born with any fear or prejudice whatsoever, either of snakes, mice or the dark, to cite but a few of the most familiar common fears usually considered as of "instinctive" origin. All such fears or prejudices are *acquired* by learning, and may, and usually do, act as conditioned reflexes, simulating physical reflexes which are innate, but which in the former cases are conditioned to react culturally—not biologically or instinctively.

Upon the innate prejudice theory how are we to account for the well-authenticated fact, familiar to most people of experience, that children of one nation brought up in the milieu of a "foreign" nation feel no prejudices whatsoever, in wartime or out of it, against the nation of their adoption, but on the other hand are generally to be found in the ranks of their adopted land fighting against the motherland of their ancestors, whether it be in ideas or in powder? The most notorious example of this is the case of Houston Stewart Chamberlain, the egregious author of that stupendous miracle of nonsense, "The Foundations of the Nineteenth Century," in which the spec-

tacle is witnessed of an apostate Englishman glorifying the Teutonic spirit, and the German brand of it in particular, at the expense, among others, of his ancestral land and heritage. One may well wonder what happened to the "birth-right" of prejudice of Chamberlain when, as an adult, he became a champion of German prejudices? Possibly William James's law of transitoriness of instinct may be invoked here! And what shall we say of the author of the "Religio Medici" who wrote, "I am of a constitution so general, that it consorts and sympathiseth with all things; I have no antipathy, or rather idiosyncrasy, in anything. Those national repugnances do not touch me, nor do I behold with prejudice the French, Italian, Spaniard, or Dutch"? As a matter of fact, there is every reason to believe that race sentiment and antipathies are comparatively recent developments in the societies of Western man. Lord Bryce in his Creighton Lecture, "Race Sentiment as a Factor in History" (1915), after surveying conditions in the ancient world, in the Middle Ages, and in modern times up to the French Revolution, arrives at the following conclusions which he regards as broadly true. The survey of the facts, he says,

has shown us that down till the days of the French Revolution there had been very little in any country, or at any time, of self-conscious race feeling. . . . However much men of different races may have striven with one another, it was seldom any sense of racial opposition that caused their strife. They fought for land. They plundered one another. They sought glory by conquest. They tried to force their religion on one another. . . . But strong as patriotism and national feeling might be, they did not think of themselves in terms of ethnology, and in making war for every other sort of reason never made it for the sake of imposing their own type of civilization. . . . In none of such cases did the thought of racial distinctions come to the front.

In America, where white and black populations frequently live side by side,

it is an indisputable fact that White children do not learn to consider themselves superior to Negro children until they are told that they are so, a fact which is beautifully illustrated by the words of a white American farmer from down South, who, in answer to the query as to what he thought of the Negro, replied, "I ain't got anything against niggers; I was fourteen years old before I know'd I was better than a nigger." Numerous other examples could be cited of the cultural acquisition of prejudices, but to enter into a fully satisfactory discussion of the mechanism of race prejudice here would be quite impossible; it need only be said in this place that it has been abundantly proven that race prejudices, or ideas of any kind, are inherited in just the same way as our clothes are, not innately but culturally. The statement so often made that "war is a universal and everlasting law of Nature" is at best a shallow judgment, for it seems never to occur to those who make it that the "conflicts" which they are pleased to term "war" and which are alleged to take place between animals in the wild state are pertinent only when they refer to the conflicts between animals of widely separated species, orders and, almost universally, classes. Thus, mammals prey upon reptiles, reptiles upon birds, and birds upon insects. Lions will attack almost anything that moves, so will, to a lesser extent, wolves and hyenas; domestic cats will kill small rodents and birds; monkeys will kill and eat birds and insects, but in all these examples chosen at random not a single animal will "fight" with a member of its *own* species in the sense that it will fight with members of other species, orders or classes of animals. In the wild state it is not the practice of animals to prey upon or fight with each other, but rather with animals of widely separated species. When they do fight with each other the results are rarely fatal and approximate

more often than not to play. Of course, very hungry animals will devour, upon occasion, members of their own species, but this is a form of conduct which is normally resorted to only of extreme necessity. In serious conflicts between wild or domesticated animals of the same species the fight is invariably between rarely more than two individuals, and the fight is usually provoked by the same causes and is fought from motives similar to those which cause men to fight with one another, namely, the possession of a sexually desirable mate, or an object of physical value such as food. But this sort of fighting is a very different thing from the fighting which we know as "war." War is an organized attack of one community upon another community, and as such is never fought by animals other than those of the "human" variety. It is impossible to produce a single instance from the animal kingdom, outside of man, in which it is shown that within a definite species a form of behavior resembling warfare is waged by one group of its members upon another, or for the matter of that upon any other order or class of animals—as a means of improving the species or what not. If one thing is certain it is that it is *not* natural for either members of the same species or of any other to wage "war" upon one another. War, let it be said at once, is the most unnatural, the most artificial, of all animal activities, for it originates in artificial causes, is waged by highly artificial entities called states, is fought from artificial motives, with artificial weapons, for artificial ends. Like our civilization war is an artificial product of that civilization itself, the civilization that has been achieved by the repeal and the repudiation of those very processes of so-called Nature which our von Bernhardis are pleased to regard as an everlasting universal law.

We have already seen that there is good reason to believe that aggressive

race sentiment and prejudice is a comparatively recent acquisition of man. So too, there is very good reason to believe that warfare is but a recent development resulting from the artificial and perverted activities of men living in highly civilized groups. Amongst the extinct races of men of whom we have any knowledge no evidence of anything remotely resembling warfare has ever been found. Plenty of weapons of a rather simple nature have been discovered in association with the remains of ancient man but these were clearly for use against animals, and not against himself. Adam Smith long ago pointed out that a hunting population is always thinly spread over a large area and possesses but little accumulated property. Primitive man was, and in many cases still is, a hunter, and no doubt, as is the case amongst most existing primitive peoples, his hunting grounds were marked off by definite boundaries, boundaries separating different communities, "but these boundaries were sacred, and as no one would think of violating them they could not form a cause of war." Wars for conquest among primitive peoples are completely unknown.

"Savages," writes Ellis, "are on the whole not warlike, although they often try to make out that they are terribly bloodthirsty fellows; it is only with difficulty that they work themselves up to fighting pitch and even then all sorts of religious beliefs and magical practices restrain warfare and limit its effects. Even among the fiercest peoples of East Africa the bloodshed is usually small. Speke mentions a war that lasted three years; the total losses were three men on each side. In all parts of the world there are people who rarely or never fight; and if the old notion that primitive people are in chronic warfare of the most ferocious character were really correct, humanity could not have survived. Primitive man had far more for-

midable enemies than his own to fight against, and it was in protection against these, and not against his fellows, that the beginnings of cooperation and the foundations of the State were laid."

War came into being only after men had taken to the cultivation of the land upon which it was necessary for them to settle permanently. Such an agricultural stage of development we know first to have appeared among men not more than twenty thousand years ago in the Magdalenian Age. The agricultural life results in the accumulation of property, the accumulation of property results in more or less organized industry, industry in wealth, wealth in power, power in expansive ambitions and the desire to acquire additional property—the source of additional power—necessary to gratify those ambitions, and thus by no very complicated process—in war. Such conditions as are peculiar to the industrial civilizations of to-day are, of course, highly artificial, as are the prejudices and race sentiment which they serve to generate.

In the modern world undoubtedly the most potent cause of war is economic rivalry—a purely cultural phenomenon having no biological basis whatsoever. The desire for foreign concessions, and foreign markets, the increase in population, "lebensraum," such things will upon little provocation set nations in opposition and at each other's throats. It is from such economic causes that patriotism, chauvinism and the widespread fear of aggression, which more than anything else serves to consolidate the group and is responsible for the generation of race sentiment and prejudice, is born.

If all this is true, then it is apparent that war arises not as the result of natural or biological conditions but from purely artificial social conditions created by highly "civilized" modes of living.

There remains to be examined the

statement given expression by Sir Arthur Keith, and implied in the writings of many before him, that war is Nature's "pruning hook," Nature's method of keeping her orchard healthy. This, of course, means that war acts as a process of natural selection—an idea which on the face of it is preposterously absurd, for, as everyone knows, the manner in which modern war acts is to kill off the very best members of the race whilst jealously preserving the worst, such as the mentally and bodily diseased and the generally unfit. And in any case, as the last war fully proved, the nation superior to all others in the processes of waging war, the most ingenious and fertile in the invention and use of the instruments of destruction, may in spite of this lose the war by the selectively irrelevant fact of being overwhelmingly outnumbered. In writing of the late war Professor Pollard has in this connection aptly remarked that "if the result had depended on scientific invention the Germans would have won. As it was, they neutralized enormous odds in numbers to such an extent that for four years the principal front hardly shifted on an average more than half a dozen miles in either direction. The Allied victory was due not to scientific superiority but to the economic exhaustion of the foe, and to the fact that in Foch's decisive campaign America was pouring more fresh troops into the line of battle in a month than the Germans could raise in a year." From the standpoint of natural selection it is apparent to all those who lived through it that the Germans, who proved themselves the most intelligent and certainly not the least valorous of all the combatants, should have won the last war. Instead, they lost it. Something, clearly, has gone wrong with natural selection, or rather with war as an agency of it. As a matter of fact the whole concept of war as an agency of natural selection in the case of man completely breaks down

when we consider that throughout the historic period there were numerous instances of victories in war gained by nations who were culturally far inferior to the peoples whom they conquered. It must, however, be freely acknowledged that on the whole up to the modern era the nations victorious in war were generally superior to the people whom they conquered—superior in the strict sense of the *military* superiority of the combatant *individuals*. In former wars men actually fought with one another, the superior warrior generally killing the inferior in hand-to-hand combat. But in modern warfare the combatants scarcely ever see each other, and when they do it is not military skill or native superiority which decides who shall die, but a shell fired from a battery some five to ten miles away, or a machine gun hundreds of yards distant, or a bomb dropped from an aeroplane a mile or more up. In actual battle the superior men are the first to go over the top, in dangerous and generally useless raids they are the first to be chosen—and killed. Where in all this slaughter is there to be detected any symptom of natural selection? Selection, certainly, in that the superior are selected for death and the inferior are protected against it—in this way does modern warfare act as an agency of natural selection—for the worst.

Man has reached his present supremacy of reason through the inhibitive and integrative powers of his mind, the ability to reject and suppress what he considers to be undesirable, the ability to *control*. Human society depends upon the maintenance of that ability of the mind to control, not so much the brute in man—for there is really little that is brutal in him that is not forced upon him—but those elements which under miseducation are capable of making a brute of him. All that is fine, noble, beautiful and desirable in our civiliza-

tion has been achieved by the supercession of mind over Nature, and much of this has been achieved through the resolute determination of individual minds not so much to conquer and to vanquish what is customarily called "Nature" red in tooth and claw, but to enlist the aid of "Nature" in the service of man, and to control it effectively. All that is so ugly and inhuman and so destructive in our civilization is due to the activities of those who are anxious to exploit their fellow men to their own advantage and who use measures of control only towards this end. To them war is a profitable activity, for it increases their fortunes and thus their power. It is individuals of this order, in all countries, and from the earliest historical times, who make wars, not Nature: "the fault, dear Brutus, lies not in our stars, but in ourselves."

Let those who are wise enough awaken to the fact that too long have they been deceived by a chaos of ideas for which there is not the slightest basis in fact, but which represent, as Spinoza said, the errors of the ages grown hoary with the centuries. Let men realize that such flowers as bloom in the verbal spring of such thinkers as von Bernhardi and Sir Arthur Keith have nothing whatsoever to do either with the logical case or the factual reality. Nay, in spite of Kant *et al.*, there is no instinct towards peace in man just as there is none towards war. The early Egyptians, the Cretans, and the people of Mohenjodaro in India, did not wage war because it was totally unnecessary for them to do so; socially and economically they were entirely sufficient unto themselves. Aboriginal Australians, however, have fought with one another, because for economic reasons—such as a dog or a wife—it was necessary for them to do so. Men, it seems, only fight when and if they want to; there is nothing within their native

structure, no *primum mobile*, no innate prejudice, save for such prejudices as have been cultivated in them by education, that originally forces them to fight.

The tradition of thought which renders possible such glib talk of war and its supposed natural causes as I have here surveyed, represents the bequest to us from the remote past of obsolete modes of thought which are conspicuous for their profound irrationality. So powerful is this traditional detritus that it has not failed to influence many of the most respected minds of our day, to the extent of making mathe-magicians of our mathematicians, casuists of our philosophers, and an apologist for war of the gentlest and among the wisest of our anthropologists. This tradition consti-

tutes a Gordian knot that is so tied that to escape its bondage one must sever the knot completely—since it resists being untied. At present this tradition of thought constitutes the sole constrictive force operating upon the mind of man as well as the main impediment in the way of its rational functioning, coercing the good in him towards evil and, in short, representing a tyranny of the strongest and subtlest power. If man is to be saved from himself before it is too late this tyranny must be broken, and this can only be achieved by the unequivocal action that must follow upon the reasoned dissolution of such errors of belief and thought as form so great a part of our traditional social heritage to-day.

POPULATION TRENDS IN THE UNITED STATES

By Dr. CONSTANTINE PANUNZIO

DEPARTMENT OF ANTHROPOLOGY AND SOCIOLOGY, UNIVERSITY OF CALIFORNIA, LOS ANGELES

THE United States Censuses of 1930 and 1940, together with the vital statistics of the last few years, make it clear that the population of this country is undergoing important changes. At least four major trends seem to be well established: the population is increasing at a steadily lower rate and is fast moving toward stationariness; the growth of the city is slowing down and some cities are losing population; the poorer classes are continuing to multiply at a greater rate than the rest of the people; and the old age segment of the population is greatly increasing. Stated thus simply, there would seem to be nothing of extraordinary importance in these trends. When analyzed, however, it becomes clear how they ramify and reach into almost every aspect of personal, social and national life.

I

The first bold fact which recent data bring out is that the growth of the United

States is slowing down and slowing down rapidly. This phenomenon, though general nearly throughout the Western world, is more impressive in the United States because of the rapidity with which its population grew up to a few decades ago and because of the sharpness with which that growth is declining. The inhabitants of this country increased thirty-three times in a century and a half: from less than 4 millions at the time of the first census in 1790, to 23 millions in 1850, to nearly 76 millions in 1900 and to nearly 132 millions in 1940. But the rate of growth has dropped rapidly, almost precipitously, especially recently. The birth rate decreased from an average of 42 per thousand in the 40's and 50's, to 37 in the 60's and 70's, to 30 in 1900, to 26 in 1910-1919, to 20 in 1928 and to 17 in 1938. The rate of total increase (natural increase plus immigration) dropped from about 36 per cent. per decade until 1860, to 21 per

cent. from 1890 to 1910, to 15 per cent. from 1910 to 1920, to 16 per cent. from 1920 to 1930 and to about 7.2 per cent. during the 1930-1940 decade. This last rate is less than one half the rate for any decade since 1790. In absolute numbers, the increase was a little over 10 millions in 1880-1890, nearly 13 in 1890-1900, nearly 16 in 1900-1910, nearly 14 in 1919-1920, 17 in 1920-1930 and in 1930-1940 about 9 millions. The decline in rate of growth is so marked that the population of the country will stop increasing and become more or less stationary within the next few decades.

The basic reasons for this decline are somewhat obscure. The reduction of immigration, sometimes believed to be the cause, can not be held responsible because the decline was already well established when immigration was in full flow. Some attribute it to the great depression, but the decline began long, long before the autumn of 1929, and the period that has followed. Others find the source in birth control, but the slowing down of population growth is general and not confined to those segments of the population which practice birth control; furthermore, birth control is but a symptom, or a means, not itself the basic cause. Still others attribute the decline to the stress of city life, to a desire on the part of large numbers of people to follow personal ambition and to spend their energies and money in other ways than having children, to the growing insecurity of our era. All these and other factors have probably had an influence in bringing about the decline, but they themselves are rooted in deeper causes which remain more or less unexplained.

This trend would seem to be in the order of a natural phenomenon. The population of this country increased at such a rapid rate in the eighteenth and first part of the nineteenth centuries that it could not possibly have continued

to increase at the same rate indefinitely. So long as population was small it could double itself in twenty-five years or so without producing extraordinary pressure on resources; but when it reached a hundred millions or more, it could not possibly go on multiplying at the same rate. Although the figure is not strictly applicable, it would be like expecting a balloon which in the early stages of inflation had expanded at a high rate to continue to expand at the same rate when it was almost fully inflated. In other words, the present reduction in the rate of increase is in the very nature of things; and students of population foresaw it half a century ago and have been able to measure and even predict it with increasing accuracy.

There is no reason for alarm, however, in this slowing down of population growth. The slowing down will be gradual. Were the population suddenly to stop growing, that would be a serious matter, since it would produce a considerable disturbance in the economic system and other aspects of our society. In fact, the population of this country will continue to grow for several decades to come: it will increase to about 141 millions in 1950, 150 in 1960, 155 or 160 in 1970. It will probably become stationary, at perhaps 175 or so millions, in the latter part of the present century; but the societal structure will gradually adjust itself, and the changes *per se* need not and probably will not cause any major disturbance.

The slowing down of growth and even a stationary population may, in fact, be advantageous. This country now enjoys a marked advantage in the matter of resources. With a crude density of about 41 per square mile at present and a crude density of 47 per square mile when it does reach a maximum population of 175 millions, this country has and will continue to have an enormous advantage over other nations. What this

means can scarcely be realized. France, for example, has a density of 198 per square mile, Germany 372, Italy 360, Japan 492, England and Wales 703. Crude density is not, of course, the truest of measures, as only the relation between population and resources, especially land, can give the true position of a country. Yet even the ratio between population and usable land alone gives and will continue to give the United States a marked advantage; for, while most countries are already using nearly all their usable land, in the United States it is estimated that 322 million acres more can be added to the 478 million acres now in improved farming.

A slower growth or a stationary population, therefore, is not something to be feared; it will call for adjustments, as we shall see below; but in its totality it is to be desired; it will make it possible for the people of the United States to continue to enjoy an abundance of resources and a relative good standard of living; and it will give them opportunity to stabilize, if they will it, their economic life, and even to eliminate some of the economic maladjustments which now prevail.

II

The second striking fact which recent Census data bring out is the slowing down in the rate of city growth. In this respect, also, a marked change has occurred. The urban population in the United States increased more or less steadily from the founding of the nation to the recent past: from 6 per cent. of the total population in 1800 to a little over 15 per cent. in 1850, to nearly 40 per cent. in 1900, to 56.2 per cent. in 1930, to 56.5 per cent. in 1940. In addition, the number of large cities also increased: from 6 cities of 100,000 or over in 1860, to 19 in 1880, to 34 in 1900, while in 1930 there were 93 cities with 100,000 or more population, and five cities with one million or more inhabitants.

This expansion of urban population, however, began to slow down after 1900; during the 1920-1930 decade the decline became marked, spreading to practically all sections of the country, while 532 cities actually lost population; and by the 1930-1940 decade the decline in city growth became very pronounced.

The reports of the 1940 Census make this clear. During the 1920-1930 decade, the cities grew 25.5 per cent., while the country as a whole increased 16.1 per cent.; in 1930-1940, the cities grew 5.0 per cent., the country 7.2 per cent. Again, whereas only 23 cities of 25,000 and over declined in population in 1920-1930, 108 or nearly five times such cities experienced a decline during the 1930-1940 decade. In 1940 there was one less city with 100,000 population than in 1930. Moreover, while the 25 largest cities experienced a marked growth during the previous decade, they either lost population during the last ten years or increased very little: seven increased but slightly; nine lost population (Jersey City losing enough to be displaced from the list of the 25 largest cities); five, namely, Boston, Cleveland, Philadelphia, Pittsburgh and St. Louis, lost all the way from 0.7 to 2.4 per cent. of their population; Chicago barely escaped a loss by having a gain of one fifth of 1 per cent.; while New York had an increase of only 6.5 per cent. Los Angeles and Miami were the only two which increased appreciably in 1930-1940: Los Angeles 21 and Miami 34 per cent.

The reasons for the retardation of city growth are clear. First, there are limits to sanitation, communication, transportation, housing, etc., and when a city reaches considerable size, its rate of growth naturally decreases. Second, the city is not growing so rapidly as in the past because non-urban population growth has slowed down. Since the city depends on rural population for its replacement and since the increase of rural

population has itself been slowing down, the city can no longer draw from the rural areas to the same degree as in the past; the net migration from farms to the cities was approximately 6 millions in 1920-1930, while it was only 2,179,000 in 1930-1940. Third, the city was the destination of nearly 90 per cent. of the foreigners who entered the country, but since immigration has virtually stopped—in fact, 30,000 more persons left than entered this country during the last decade—the city has lost this source of growth also. Fourth, there has been some decentralization of industry and a considerable removal of residence out of the metropolitan centers. And finally, the depression has made life in the larger cities less and less secure and life in the country relatively more secure. A factor which may accelerate this trend in the coming decade consists of the vulnerability of the great city to aerial attacks. It is possible that some of the war industries—no small proportion of total industrial enterprise—will be located at points away from the large cities, where land is cheap enough to make possible a subterranean development of these.

Whatever the forces at work, the slowing of city growth need not be regarded with apprehension. As the preliminary Census figures were being published during the summer of 1940, one could almost hear the people of Philadelphia, Boston and New York groan over the fact that their city had not increased so fast between 1930 and 1940 as in the previous decade. They seemed to be humiliated, as if a misfortune had overtaken them.

The slower growth of the city is certainly not a misfortune and may prove to be a definite advantage. Objective students of society have known for some time that rural life is more favorable to marriage and to a sane married and family life; that rural people live longer (if that is an advantage in these times); that the death rate is lower in rural

areas, despite notoriously inadequate medical services; that the rates of divorce, dependence and other maladjustments are lower in the country districts; that life is simpler, more socially direct, less sophisticated, less infected with organizations or stifled by "total" materialism. The rural community is not, to be sure, a paradise, for it contains as bad festers as the city; still all in all it affords an opportunity for as high if not a higher standard of life than the larger city for the masses who live there.

A retardation of increase of urban population may also contribute to the stabilizing of city life itself. Some of the worst evils of city life, such as slums, high rents, sweat shops and political corruption, have been concomitants of rapid city growth and need not necessarily be permanent features of city life itself.

The slowing down of city growth, advantageous or disadvantageous though it may be, will, however, have important results. It will probably produce an excess of agricultural population, an overpopulation in the depopulated areas, and a further lowering of a standard of living which is already shockingly low in some agricultural areas; it will accelerate migration of laborers and thereby increase such instability of family life as prevails in rural areas; while such cityward movement as will continue will be ever more selective in that it will draw mainly the most capable and fewer of the less capable, thus making the problem of rural leadership more difficult.

These results will call for economic and other readjustments. An agricultural-industrial economy will need to be developed, by the systematic introduction of small industries in the rural areas, providing for duality of occupation and supplementary income for the farm population; capital will need to look increasingly away from the city and more toward the rural areas for the ex-

pansion of both production and business activity; while wage and hour laws will need to be modified to make possible these developments. The educational, public health, recreational and other facilities of the country districts will need to be improved, even beyond the remarkable record already established.

III

The third broad fact recent data—in this case vital statistics—bring out is that the underprivileged, as in the past, are increasing at a greater rate than the privileged. This is not a new fact, but only recently have we had precise data. These data clearly show that for some decades business and professional people have had the lowest rates of increase, the skilled and semiskilled coming next, and the unskilled having the highest rates. The size of the family also has been decreasing rapidly for the “upper classes,” moderately for the middle and wage-earning classes, while farmers’ families have increased in size, farm-owners 5 per cent. and farm laborers 13, between 1900 and 1930. There are other evidences that point in the same direction. For example, families having an annual income of less than \$750 and those on relief are estimated to have contributed one third of the 2,000,000 births which occurred in the United States in prosperity-year 1929; those engaged principally in agriculture contributed 55 per cent. of the natural increase for the entire country in 1930–1935; while the largest proportion of this increase was made by the poorest elements of the farm population. In fact, the poorest farm population had in 1930 an increase of 76 per cent. more than necessary for its own replacement.

This fact, that the poorer elements of the population are contributing more than their proportion to the population is nothing new; “the poor are always with us,” and have probably always re-

produced themselves at a greater rate than the rest of the people.

What is new is the anxiety which one often hears expressed over the fact. This anxiety, in turn, is based on the notion that the so-called lower classes are generally of low quality. How this idea arose and became rooted in this country, which only yesterday held the “shirt sleeves” philosophy, is in itself an interesting story. It seems to have arisen alongside the birth control movement to be entertained mainly by those who are not reproducing themselves, and to contain elements of sadism. That is, people who have no children and who thereby see their families being extinguished get a sense of compensation for that loss by considering those who do perpetuate themselves as “inferior,” to which the “inferior,” if articulate, might well reply in the words of Daly’s poem:

My “koods ees no good breed,” you say
Ah wal, ess mabbe not,
But day weell be more good som’ day
Dan dose you don’ta got.

In any event, the notion of the inferiority of the underprivileged does not rest on scientific fact. There is no evidence that low income, unskilled occupation, meager or no education, poor habitation or even color, ethnic background and nationality have anything to do with biological or other kind of inferiority. Heredity and environment are so inextricably interwoven that no reputable scientist dares claim that one or the other is responsible for poverty, lack of education or what not.

Nor is the idea of the inferiority of the lowly based on historical fact. This country was inhabited from the first and has been brought to its position among the nations of the earth by the “common people”; the “common people,” from the days of the Puritans and the Pilgrims to this, have contributed a considerable proportion of the population; they have directly furnished at least

their proportion of the leadership of the country, as any biographical list, such as the "American Biographical Directory" or "Who's Who," will show; and they indirectly contributed to collective leadership by constantly replenishing the city population. Some really monumental leadership has arisen from the lowly; that has been one of the glories of this nation. Now, unless we are willing to claim or to admit that the population of this country is as a whole of an inferior type or that its leadership is poor, we are forced to conclude that we need not be alarmed over the fact that the poorer classes are contributing so much to the population. In fact, since the professional and other "upper classes" do not at any time replace themselves, the "upper classes" would constantly diminish and even disappear in a few generations were it not for the steady rise of leadership out of the masses.

IV

Perhaps the most important aspect of the present population situation in this country consists of the marked change which is taking place in the age composition. In 1870, for example, nearly 50 per cent. of the population of this country was 19 years of age or under, nearly 35 per cent. between 20 and 44 inclusive, and about 16 per cent. were 45 years of age or over; in 1940, on the other hand, 34.5 per cent. were 19 or under, 39 per cent. were 20-44 inclusive, and 26.5 per cent. were 45 years of age and over. Since 1820, the first date for which the age distribution is available for the entire population, the medium age had risen continuously from 16.7 years to 28.9 years in 1940. And more impressive still is the estimate that in the next decade or so this last segment of the population will amount to 30 per cent. of the total.

This "aging" of population has far-reaching significance. First, it propor-

tionately increases the labor forces. During the last decade, persons 20-64 years of age, 60 per cent. of whom are employed or seeking employment, have increased by 7 millions in this country, or from 48 to 55 millions. This increase in the labor force, at a greater rate than the total population, would be an advantage were other conditions favorable. But other conditions are not favorable; they are distinctly unfavorable. Technological improvement has lessened the demand for workers; national income or foreign trade has not sufficiently increased as to take up the surplus; while unemployment has generally increased. Weighing the various factors, it is estimated that 9½ millions potential workers have been added during the last decade, whereas about 3 millions would have been sufficient to supply the needs of the additional population. To absorb this increased labor force, to prevent a permanent dislocation of the market and a decline in the national wealth, calls for a major "operation" in the financial, industrial, business, employment and occupational structure of this country.

Again, the aging of the population is changing consumer habits and therefore will call for modification in production and financial structures. Consumer needs will change; more income will be expended on old-age goods and services, less on children's and young people's. "The market for wheel chairs [may] outsell the market for perambulators . . ."; and there probably will be "less playgrounds and more golf courses . . . less milk and more whiskey." As aged persons are conservative spenders and primarily dependent on savings rather than earnings, capital will flow much more slowly than at present.

Second, as the population ages an increasing number of aged persons will become dependent on the productive workers, particularly in view of the practice, perhaps inevitable, of indus-

trial and business concerns to discard workers of 45 years and over. Part of the burden will be carried by social security and old-age pensions; but much of it will rest on the shoulders of relatives and friends. In the day-by-day weight, these burdens may seem fragmentary and invisible, but in their aggregate they are enormous. In addition, there will be an increase in the burden of taxation. Many more persons will be drawing pensions and drawing them longer, many more will receive care in establishments for the aged and for longer periods; and the state, as well as private philanthropy will be called upon to increase its services to the aged and the solitary.

Third, the aging of population will call for changes in the educational system. There will, of course, be fewer children to educate. There will be relatively fewer children in urban schools; not only their numbers will be proportionately smaller, but if unemployment should continue at the present rate, parents will find it increasingly difficult to maintain their children in school beyond the required minimum. This may be an advantage in the long run, since it will prevent many from going to "college." Reduced numbers will make it possible to eliminate some of the mass-production features of our "higher" education and to approximate a quasi-individual education, provided, of course, staffs are not reduced. The demand for teachers will not continue to expand as it has in recent decades. Urban educational equipment will not need to be enlarged at the rate of recent decades; and administrators may pay more attention to the improvement of personnel. School buildings will be used for longer days and more nearly throughout the year; adult and old-age education will be in greater demand, especially in the cities. On the other hand, the rural educational population will probably be proportion-

ally larger, rural school facilities will need to be expanded considerably; schooling will need to be directed more toward the practical arts and more persons will find their field of activity and happiness as rural teachers and perhaps bring back a part of the rich life-unifying tradition of the "little red school house" which contributed so greatly to the making of early America.

Professional changes will also occur. There will be need for more physicians to deal with old-age diseases and less for those dealing with maternity and child diseases. The movies and vaudeville entertainers will have in part to turn their sex appeal to the retrospective and consolation appeal. And as the aging of population will inevitably increase the death rate, there will be more funeral establishments—politely known as mortuaries—and more mellifluous competitive radio or billboard advertisements setting forth the advantages of being buried in one place as against another.

Again, as women and elderly persons tend to prefer the city, urban centers will come to have a greater proportion of these elements. Embellishing or veneering establishments, so-called beauty parlors, will multiply, and one will see more women sprawling to the view of the passer-by with massive helmets over their heads and latest exotic magazines in their laps; and in the absence of children and grandchildren, more people will rely on the affectional response of dogs, cats, parrots and other animals, and the pet population of every city will greatly increase.

Fourth, the aging of population will probably produce changes in the total outlook of the community. The proportion of youth being small and of the aged larger, some of the "willingness to sacrifice, courage, power of initiative and creative imagination" which characterize youth, will be replaced by "the calm presence of mind, the patient care, and

the greater experience of life," the reflection and retrospection, which characterize the aged. Whether this will necessarily mean a wiser or more efficient living for the community as a whole is a question; perhaps it is doubtful. The tragic events of 1918-1940 make us wonder. The World War reduced the proportion of young people in the great European nations and that may have had much to do with what followed. "It was the young generation, and the best of it, that bled to death on the battle-fields, while remaining to organize peace again were the older generation, the white-feathered stay-at-homes, and a shattered, war-neurasthenic remainder of the youthful generation."¹

In any event one thing is certain, there will be many conservative persons in the population, older leaders will manage to have longer average tenure and young adults will have relatively fewer opportunities to rise. At the same time, there will be for many of the relatively older persons an increasing amount of leisure and idleness; more time to contemplate the miseries of old-age and dependence; perhaps more discontent and manifestations of discontent; more old women will find self-expression and social contact in political agitation and reform; and there will be more old-age pension activity, more fundamentalist religious sects and more suicides.

Finally, the aging of population means, of course, a proportionate decrease in youthful and young adult ele-

ments and this has a definite bearing on the security of the country. France, it will be recalled, worried for decades over the fact that its population was stationary and that of Germany was increasing. The fact that both France and England have a stationary or near-stationary population, while Germany and Italy have higher rates of increase, with the consequent greater proportion of youths and young adults, may have had considerable to do with precipitating what has been termed World War II. In any event, a population that has a higher proportion of young adults has greater plasticity and greater possibilities in the eventuality of war; and this, especially in a time such as the present, is a consideration of no mean importance.

V

The last few sentences may leave the reader with a darksome picture in his mind; and to an extent such a picture is true to fact. He is blind indeed who refuses to see the stark realities of the present-day world. On the other hand, there is a cosmic optimism in the fact that populations have again and again undergone the very changes discussed above and have, somehow, pulled themselves up again, by their bootstraps as it were, at the very moment when they seemed to be sinking into the mire of decadence; and somehow they caught their breath, survived and have started on the path of growth once more; and in the next round of growth they have made some little gain toward the attainment of the good life. So, perhaps, it will ever be till the end of time.

¹ Gunnar Myrdal, "Population" (Cambridge, Massachusetts, 1940) p. 161.

INCUBATION STAGES OF SCIENTIFIC INVESTIGATION

By Dr. C. JUDSON HERRICK

PROFESSOR EMERITUS OF NEUROLOGY, THE UNIVERSITY OF CHICAGO

I

Two preceding articles in this MONTHLY have sketched the development of scientific activity at the northwestern frontier up to 1875 and the contributions made at that time by an earnest group of boys of high-school age as recorded in the minutes of the Young Naturalists' Society. In continuing this narrative we here report additional details of the activity of the society, together with an evaluation of its products. As in previously published excerpts from the minutes, the Reports and other papers are here printed exactly as written by these boys.

The interest attaching to these old papers, it will be recalled, is two-fold—first, as a historical record of the scientific frontier at a critical period, and second, as a human document, revealing germinative stages in the development of eminently successful scientific investigators. A passion for natural science, apparently generated spontaneously, is here projected on the screen in a series of slow-motion pictures caught at the crucial moment when the undifferentiated germ of scientific curiosity is beginning its dramatic career of growth and specialization. Without further introduction, we now resume the survey of these documents.

In secretary Herrick's report at the end of the society's first term (July 2, 1875) he writes:

"We have completed one half year of our existence as a society and it seems proper that we should review the half year's work and see if the result is a good equivalent for the time expended. Among the aims as set forth in the constitution of the Y. N., we find the following.

"1st. 'The promotion of a love of Natural Science.' This I think has been accomplished. . . .

"2d. 'To facilitate the study of the same.' This is perhaps the most important one of all and we think that there has been a good degree of success in this direction. . . . We have indeed lacked the reliable books which we need to aid us on many of these subjects, but have gathered some practical knowledge which can be made available at such times as a book of the right sort comes to hand.

"4th. To give an opportunity for the establishment and preservation of interesting facts or discoveries which may come under the observation of the members. . . .

"5th. 'To provide a correct list of the Fauna & Flora of Minnesota, etc.' This has occupied the larger share of our attention as is right, for it is acknowledged by all that observation comes first and theory afterwards, and we often find societies of young men which devote all of their time to theory and speculation and thus losing sight of the true means of making theory develop into fact. . . . We think that nothing has been placed in any of the lists alluded to which is not accurately correct. The following numbers show the practical business of the society for the half year just expired. Specimens collected—

Ornithology,	122
Entomology,	13
Botany,	10

These lists do not include any specimens except those actually taken by the members, otherwise it would assume a more pretentious size, and a large number of specimens in all the branches except Ornithology are now in the possession of members of the society awaiting a chance for identification. . . . Because of the lack of practical information from books we have not made such advancement as might be wished.

"6th. 'To form a collection,' etc. The lack of room has been a drawback to this department and the Museum contains now the following specimens, Birds, 23, mammals 4, minerals 26, and several insects.

"7th. Practical observations, have been

rather a failure but on the whole we have abundant cause for congratulation."

In secretary Lum's report of July 1, 1876, we read,

"The society in the last six months has made but two additions to the list of insects and five to the list of birds, increasing the list of insects to twenty-seven and the list of birds to 174. It is to the Botanical list that the greatest addition has been made. At the beginning of the year there were only ten names on this list while now there are 110."

Secretary Lum reports six months later (Jan. 1, 1877) that the lists of fauna and flora now are as follows: Ornithology, 188; Botany, 131; Paleontology, 32; Zoology, 31. He also lists several accessions to the library. Secretary Roberts' report at the end of the third year (Jan. 14, 1878) was summarized in a preceding article.

The six reports of committees for the term ending Dec. 31, 1876, contain some significant passages. We quote from Mr. Roberts' report on Ornithology:

"I have thought that probably the best course to pursue in preparing this, the first, report would be to begin as far back in the history of the Ornithology of Minnesota as my knowledge would permit, and rapidly review the different articles, on this subject, that have appeared up to the present time. As it has been but a few years, comparatively, since this country was explored and settled, the ornithological literature relating to it is not very voluminous."

The larger part of this report is devoted to a comprehensive and critical digest of this literature, concluding with this passage.

"A number of species are yet to be added, as ultimately three hundred (300) forms and perhaps more will undoubtedly be found in the state. Here is work not for two or three but for many, and as the list increases the work becomes harder and the results less than when it is small. But the greater the achievement if a new species be added after the field has been thoroughly worked. Moreover the making out of lists is Only a portion of the work. It is necessary that a long period of time be devoted to a careful study of the habits at different seasons of the year; dates of arrival and departure; time, place, and circumstances attending the breeding; relative abundance during successive years; &c. &c. of each species, in order that we may have a complete history of the avi-fauna alone. So it is evident that we have a vast amount of work before us which will much more than occupy all the time we can devote to it."

Sixty-five years have elapsed since this ambitious program of real natural his-

tory was laid down, and during the whole of this period Dr. Roberts has devoted himself to its consummation so purposefully, persistently and skilfully as to win recognition as one of the leading ornithologists of this continent.

Mr. Williams' report on Botany also summarizes the scanty literature of the flora of Minnesota and reports progress in the compilation of a list for the vicinity of Minneapolis.

"The beginning of such a list has already been made in the society, and considering the comparative short time that the society has existed and the few who have taken hold of this matter, more has been accomplished by this society, probably, than by any other in the state. To make a complete list must require a person well acquainted with botany as there are, without doubt, many new varieties and some new species to be found here not before described. Thus it remains for some one to distinguish himself by identifying these."

Mr. Williams did not achieve this distinction, but he did win first rank in another and a larger field as our leading authority on the mosses.

In Mr. Herrick's report on entomology he says,

"The points which have begun to attract general attention of late are those respecting geographical distribution and some particular variations in minor characteristics, such as color, considered in relation to preservation and propagation of specific differences. In a word those particulars which bear most directly upon the theories of mutability of species and their derivation have in entomology, as in other branches, received more general attention."

In the following pages there is evidence of careful reading of the current works of Darwin, Wallace and Packard and of correspondence with Dr. Packard regarding evidence that various stages of one insect have been described as members of different genera.

The report on Geology and Mineralogy by Mr. F. S. Griswold opens with the statement, "Little has been done by the members of the Society, collectively or individually, in this line, with the exception of Mr. Herrick, who deserves

great credit for his perseverance in working up the fossils of the Trenton Limestone." Then follow recommendations for enlarging and systematizing the collections and summaries of Professor Winchell's reports on the stratigraphy of the state in relation to waterpower, glaciation, etc., and other recent literature.

In March, 1878, a report was submitted to Dr. P. L. Hatch, state ornithologist, by Roberts, Williams and Herrick, an "exact copy" of which is among the papers of the Young Naturalists' Society. This is a remarkable document to come from the hands of youths of about twenty years. There is a record of one species new to the state and detailed field notes on the rare Leconte's bunting, *Coturniculus lecontei*. These and similar notes on several other species show that the uncommon capacity for acute and critical observation which characterized these three naturalists in later life was already mature. This unpublished report is really an addendum to Mr. Herrick's report to Professor Winchell dated December, 1876, and published under the title "Ornithological Notes" in the Fifth Annual Report of the Geological and Natural History Survey of Minnesota, for the year 1876.

The list of birds assembled by the Young Naturalists' Society ultimately grew to several hundred, as indicated by a passage in Professor Winchell's Annual Report of the Survey for the year 1883, where on page 10 we read, "A list of about 500 species, observed chiefly in the vicinity of Minneapolis by the Young Naturalists' Club, was communicated by Mr. Thomas S. Roberts, by whom nearly all of these species were determined, others by Clarence L. Herrick, F. S. Griswold, and R. S. Williams." Dr. Roberts informs me that the number 500 is much too large, for there are now about 326 species and subspecies of birds recorded in Minnesota.

Of all the documents preserved the

most illuminating are the fourteen original papers. These were written in 1875 or early in 1876, the first year of the society's life. The five by Frank Ham are humorous yet rather pathetic examples of the reactions of an earnest but slow-witted farmer's boy to the stimulation of his more alert classmates. Frank was not one of the shining lights of the society and his membership lapsed at the close of the first year. Yet his brief papers on "Bees," "The Bee Moth," "Spidars," and "Poplars and Willows" show a commendable effort to canalize the routine experience on the farm into channels of scientific interest. The observations recorded were original (for him), though not new to science. The paper entitled "Promiscuous" shows the true scientific spirit of inquiry. The question arose in his mind whether plants move toward the sun principally for heat or for light. The problem was solved by a simple set-up of experimental conditions found ready to hand in the farm kitchen. A box of growing cabbage plants placed between the stove and the window turned toward the window. "Now you see that my question is answered unless there is a difference between the heat of the sun and artificial heat."

Another question suggested by the daily chores was, "do animals which make their abode in decaying vegetation have pure arterial blood. I have had special opportunity to examine the minure heap this week." The opportunity was improved by inspection of the life habits of the fauna of the manure pile, but the conclusions reached were not regarded as very reliable.

Frank reappeared on the scene several years later when my brother Clarence was teaching a summer course in biology at the university. As he related it to me afterwards, before the first laboratory exercise the class was told

exactly what equipment of dissecting instruments, etc., each student was to bring to the laboratory. On that first day grasshoppers were to be dissected. As Clarence made the rounds, here was Frank with a grasshopper in one clumsy hand and a huge farmer's jackknife in the other.

"Frank, where are your dissecting instruments?"

"I didn't bring any. You see, Mr. Herrick, I only want to get a general idea of the insect."

This recalls to my mind another story which Clarence told me about Agassiz. On a field trip with a group of Harvard boys an unfamiliar dragonfly darted past the party. One of the boys who was sent in pursuit presently returned panting, with the cheerful word,

"Here, Prof., is your darning needle."

Such levity ruffled the equanimity of a Boston clergyman of the party, whose reprimand took the form of the question,

"Professor Agassiz, what is the proper botanical appellation of this insect?"

It may be that Frank Ham's attitude was more hopeful. It is better to get a general idea of an insect or anything else directly from nature than to accumulate any number of proper botanical appellations.

The two papers by Robert S. Williams on "The Canary Bird" and "The Motory and Alimentary Apparatuses" are excellent school-boy essays containing some personal observations. In the second paper, starting with rotifers and Cyclops, he comments on their transparency and the opportunity thus given for observation of the inner economy. Then follows a discussion with illustrations of ways in which these two systems of organs are used in the scheme of classification of animals.

The seven papers by C. L. Herrick are of very unequal merit. The essay on

"Electricity" is, as might be expected, a discussion and criticism of rival theories. "The Skin and its Appendages" is a compilation of diverse facts and homologies. The brief notes on "The American Cocks" and "The Night Hawk" are records of personal observation. Under "Stray Hints" we find a manual of simple instructions for collecting and preserving various sorts of natural history specimens. One of these papers is Part First of the President's Address on "Classification." In the introduction he raises the question, Why should those who do not expect to earn a living by teaching science or writing books about it devote long, fatiguing hours to its study?

"We must look for the answer partly in ourselves. We are conscious of a good result to ourselves from such study, we are also conscious of great pleasure in the study itself and can only account for it by supposing that there is an inherent desire in us that is met by this occupation."

Here Clarence, at seventeen years of age, stated the principle of the primary motivation of scientific research as clearly as it has ever been done before or since. In the discussion of principles of classification he follows Agassiz, and here perhaps he showed less keen insight. For in the application of these principles he immediately finds himself in difficulties which were clearly recognized. The remaining parts of this address are lost, so we do not know the outcome.

The paper entitled "Embryo of Common Fowl" was read on June 18, 1877, recounting observations made and recorded with many drawings about a year before. The young naturalist here repeats the observations of the early embryologists, and apparently he had at his command scarcely more background of previously recorded knowledge than had Aristotle. The eggs were removed

from the nest on successive days and opened. Everything visible in the living condition was described minutely. On the fourth day the pulsating heart and the vitelline veins and arteries are described. Then he says, "returning to the embryo itself we see that it bears no resemblance to a hen or, indeed, to a bird of any sort. It resembles perhaps most nearly a lizard with a long coiled tail and two large eyes occupying a large portion of the head."

The best of Clarence's work is evidently not represented in these seven papers, except perhaps the one last mentioned. Among the papers there are two plates containing twenty-two neat pencil drawings of insects which were "presented to The Young Naturalists," obviously illustrating a paper which is not preserved. His reports on lists of birds, insects, plants, fossils and microscopic crustaceans are not in the files, but their substance is doubtless incorporated in subsequently published papers.

II

Though the organized life of this society was short, its influence survives. Of the subsequent lives of some of the members little is known. One of them, Clarence S. Lum, became a lawyer of note, practicing at Duluth. The careers of the three promoters and most efficient members of the society may be regarded as the natural fruitage of a growth whose seed-time and early cultural stages are here recorded. Two of them are still actively exemplifying the worth and dignity of natural history in its classical form—the study of life as it is lived in the open.

Robert Statham Williams was born in Minneapolis on May 6, 1859. He attended the high school and before graduation entered the University of Minnesota as a subfreshman. He was active

throughout the life of the Young Naturalists' Society, and in 1876-77 he was chairman of the society's Committee on Botany.

In 1879 Mr. Williams went to the Far West, where he had varied and picturesque experiences as sheep herder, rural mail carrier and other activities in Montana and fur trader in Alaska. Throughout this period he maintained his interest in natural history. In a letter which he wrote to Thomas Roberts from Martinsdale, Montana Territory, December 5, 1879, he recounts some experiences in the saddle while carrying the United States mail and includes some observations and queries about the birds of Montana. Another letter from Montana three and a half years later shows some activity in ornithology. His interest turned to the western flora and he began sending specimens to Professor Eaton of Yale, who encouraged him to collect mosses in particular. He then went to South America and collected mosses in the Andes, where he contracted fever and nearly died. Since 1899 he has been connected with the New York Botanical Garden, Bronx Park, as research associate in bryology, and has recently returned to Minneapolis.

Advancing from the status of collector to that of taxonomist, Mr. Williams rose to the rank of our leading authority on the mosses. His first scientific paper in this field, describing two new Montana mosses, appeared in the *Bulletin* of the Torrey Botanical Club in 1902. This was followed by about 55 papers in which 165 new species and 9 new genera were described. More comprehensive studies were published in Part 2 of Volume 15 of the *North American Flora*. Many species described by others bear his name, and one genus. Regarding the latter, Mr. Williams writes me:

The moss at present known as *Williamsiella* tricolor (Williams) E. G. Britton—see Bryol-

ogist, vol. 12, p. 62, 1909 — has something of a history. Brotherus, not having seen *Williamsia* used before as a generic name, considered *Syrhopodon tricolor* Williams as not a *Syrhopodon*, but as belonging to a new genus which he called *Williamsia tricolor*. Mrs. Britton noting this, promptly changed the name to *Williamsiella* as *Williamsia* was, a year or two before, used for a tree growing well up on Mt. Apo in the Philippines, which I collected. In my trips I have always collected more flowering plants than mosses, and quite a good many have been named after me among the many new species collected.

Thomas Sadler Roberts was born on a farm near Philadelphia, on February 16, 1858. He came to Minneapolis in 1867 and entered the high school there in 1874, graduating in 1877. In the autumn of that year he entered the University of Minnesota and in 1882 he entered the Medical School of the University of Pennsylvania, from which he received the M.D. degree in 1885. After intern-ing in Philadelphia he returned to Minneapolis in the fall of 1886 and entered practice.

In 1879 he was a member of a field party of the Minnesota Geological and Natural History Survey, collecting birds and plants on the north shore of Lake Superior, and during the four following summers he was a member of land surveying parties of the old St. Paul, Minneapolis and Manitoba and Northern Pacific railroads in Minnesota, Dakota and Montana. Here he gained much information about the birds of the regions visited.

He was professor of pediatrics in the University of Minnesota from 1901, becoming emeritus in 1913. Throughout the period from 1874 to 1913 ornithology was his avocation and he has been state ornithologist since 1890. He has been professor of ornithology, curator and later (1919) director of the Museum of Natural History of the University of Minnesota since 1915. During 1939 a large and beautifully appointed new

museum building was constructed and Dr. Roberts was fully occupied with plans, supervision and the transfer of the collections.

Despite the exactions of a large medical practice and important teaching and administrative duties, Dr. Roberts has maintained a high level of scientific production. His published works include about 7 medical papers, 200 on natural history subjects and 4 books. His beautifully illustrated "Birds of Minnesota"¹ is one of the classics and was so recognized by the award of the Brewster Medal by the American Ornithological Union "for the most meritorious work on American Birds." His recently published "Logbook of Minnesota Bird Life"² contains bimonthly season reports for a period of twenty years, with meteorological and other natural history notes, the whole interpreted and spiced by sixty-six years of continuous field observation of living birds.

Clarence Luther Herrick was born in Minneapolis on June 22, 1858. During his childhood his father was pastor of several small churches and from 1866 to 1871 of the First Free Baptist Church of Minneapolis, from which he retired because of poor health to the small farm outside the city where most of Clarence's childhood was spent. Here Clarence grew up a solitary child and very early showed that spontaneous interest in all

¹ Thos. S. Roberts. "The Birds of Minnesota," 2 vols., with 92 colored plates. University of Minnesota Press, 1932, revised edition, 1936.

² Thos. S. Roberts. "Logbook of Minnesota Bird Life." University of Minnesota Press, 1939. The records of all ornithological observations made by the Young Naturalists' Society are incorporated in this work or in Dr. Roberts' "Birds of Minnesota." In the latter work (1932, vol. 1, p. 6) he gives a brief account of the "Young Naturalists" and refers to the annotated lists of birds and plants prepared by the society.

natural things which continued to be the dominant motivation of his life. His father, a frontier preacher without professional training in divinity and largely self-taught, was a man of rare insight and tolerance. Among my own early recollections are conversations between him and my older brother about the religious significance of Darwinian evolution. There was little money in the household in those days, but always there were magazines and books from the public library.

Diligent search through the family annals reveals nothing in the records or traditions of either paternal or maternal ancestry suggestive of scientific aptitude or interest. They were rugged, efficient practical folk and Clarence's paternal grandfather, Nathan Herrick, was a pioneer, emigrating from Vermont to the Mississippi Valley in 1854. To all superficial appearances his father, Henry Nathan Herrick, was no more scientifically inclined than the others, yet some of his characteristics suggest the presence of genes which, transmitted to Clarence and there rearranged in new combinations, brought forth a born naturalist.

Clarence had native talent in art and music and a philosophic mind. He was trained as an all-'round field naturalist in the best tradition of that school, a school of "natural philosophy" which takes all nature as its province, seeks personal experience in every domain of it, and attempts to rationalize all these experiences into a coherent whole. He was equally at home in field and laboratory, and the short span of thirty years of his active career covered the period of transition from field study to laboratory and experimental procedures which characterized his time and which he exemplified in his own person. In later life he specialized, and in a field which preeminently requires experience and in-

sight within a horizon which embraces all knowledge and all human achievement.

Clarence attended the Minneapolis high school for one year, then transferred to the preparatory department of the State University and soon thereafter became Professor Winchell's assistant in the State Geological and Natural History Survey. His connection with the Survey was maintained until he left Minnesota in 1885, save for the year 1881-82 spent in German universities and the autumn quarter of 1884 spent at Denison University. In the autumn of 1885 he entered upon his duties as professor of geology and natural history at Denison, where he remained until 1888. He was professor at the University of Cincinnati from 1888 to 1891, visited Europe in 1891-92, and in the latter year returned to Denison, where he remained until 1894. In December, 1893, an acute attack of pulmonary tuberculosis nearly took his life and the following ten years were spent in the far Southwest in a losing battle to regain his health. During this period he was president of the University of New Mexico from 1897 to 1901. He died at Socorro, New Mexico, on September 15, 1904.

My brother Clarence was a naturalist in the proper sense of the term throughout his life, whether engaged in field survey, teaching, laboratory work or philosophic writing. The most productive period of his life was spent in his native Middle West. He stuck to his business as teacher and investigator with few outside contacts or interests. As a teacher he was preeminent and, though the number of his pupils was never large, his stimulating influence directed a surprisingly large proportion of these into successful careers in various fields of scientific work. His most notable monuments, aside from the inspiring influence transmitted to his students and

colleagues, are the two journals which he founded—the *Bulletin of the Scientific Laboratories of Denison University*, now in its 36th volume, and the *Journal of Comparative Neurology*, established at Cincinnati in 1891 and now in its 76th volume. Near the time of his death a brief biographical notice appeared in the *Journal of Comparative Neurology* (Vol. 14, November, 1904), accompanied by a portrait and a bibliography of 135 titles of scientific works and to this list about ten others can now be added. Testimonials to his character and scientific insight have recently been published in the Fiftieth Anniversary Volume of the *Journal of Comparative Neurology*, 1941.

That their experience in the Young Naturalists' Society profoundly influenced the subsequent careers of its three promoters is evident. Dr. Roberts' whole life is a realization of the ideal program which he formulated as chairman of the committee on ornithology of the society, already quoted. The letters and published works of Robert S. Williams give similar testimony in his case. In a letter to Dr. Roberts dated October 27, 1887, C. L. Herrick wrote from Denison University:

We are progressing rapidly here. A new scientific building and museum are to be soon put up at an expense of 25-30,000. dollars. This will enable me to put in existence certain schemes entertained as long ago as when a member of the Young Naturalists' Club. . . . The school is growing in other lines also. The students are organized into a Denison Scientific Association, several of the features of which were suggested by our old experience as Y. N. Society.

III

These records of the juvenile activities of three successful naturalists reveal that the essential factor in the development of the research methods characteristic of each of these men was the inherent

quality of his own native endowment. They also demonstrate that their personal idiosyncrasies and interests were woven into the fabric of the scientific structure which each of them finally built out of such materials as were available. The details of the pattern of this structure were shaped by their daily contacts with one another, by their cultural environment—the university in particular—and by the natural configuration of the terrain within which they grew up. But the fundamental design of the structure was determined by none of these environmental influences; it was in each case an expression of the inner nature of the man.

Each of them participated in all phases of the society's activities, yet his own distinctive qualities were manifest from the start. The dating of the founding of their society is important—at the beginning of the high-school course, not at its close. The high-school years are formative, but under the direction of severe mental regimentation. This enterprise was conceived spontaneously and elaborated in detail under no external influence whatever so far as can be learned.

These children began to play with natural history, not because they had nothing else to play with, but, as the Nobel laureate Michelson later expressed it, because "it is such corking good fun." Having no one else to teach them, they taught themselves. They fumbled along, ineptly at first, but not blindly, learning by their own mistakes. Soon they found guidance in books, later in men, and they learned how to use both; but they followed nobody; each developed his own method and shaped his own career.

The scientific output of each of these men carries the stamp of the interest and aptitude of its designer as truly as does that of the artist. And these personal values can no more be filtered out from the one than from the other. It

is a whole man who describes a new species of bird or paints a distinctive portrait, not a denatured intellect in the one case or a dissundered aestheticism in the other.

Science has been so preoccupied with "analysis and ever more analysis" as too often to ignore the essential integrity of the things analyzed, and to forget that the fragments left in our hands after analytic dissection are, as such, fit only for the scrap-heap. These fragments which we have artificially separated by physical manipulation or logical processes must be reassembled, perhaps in new and more instructive patterns, or our analytic labors are wasted. Both the analysis and the ensuing synthesis are accomplished by human industry and ingenuity and they carry the stamp of the agent who does the work. The scientific generalization finally made is believed to be true, but it is not and can not hope to be a flaw-

less reflection of the order of nature. We do the best we can with the knowledge and insight available, but we must never lose sight of what Campion calls "the errorful subjectivity of human knowledge."

Natural science can be neither understood nor evaluated apart from the qualities of the men who made it and the physical and social milieu within which they did it. Any attempt to tear these components out of the scientific fabric eliminates factors which are essential for evaluation of the data and in the realm of the social sciences destroys the data themselves, for human values are the vital factors here. Do not overlook the fact that the structural body of all natural science is itself a part of that nature which it is the naturalist's business to explore. As a human achievement it has a natural history of its own, for this body of knowledge is the natural progeny of the people who generate it.

WAR PROBLEMS OF THE PHYSICS TEACHER¹

By Dr. ARTHUR H. COMPTON

CHARLES H. SWIFT DISTINGUISHED SERVICE PROFESSOR OF PHYSICS, UNIVERSITY OF CHICAGO

IN presenting to-day the first Richtmyer Memorial Lecture we are doing honor to a physicist who was more than a physicist. He trained men who are now among the nation's leaders. His teaching enabled his students to acquire the technique of exact thinking. He had that breadth of vision which helped both his students and his colleagues to understand the setting of their scientific labors and to form intelligent objectives as their goal. He thus helped to lay the foundation of a strong society.

Those of us who had the pleasure of working with Richtmyer learned to admire the straightforwardness of his thinking, the courage with which he attacked new problems and his reliability, which gave us confidence that tasks assigned to him would be well done.

To-day we have before us, as physics teachers, problems which are presented by the war. Some of these problems are new, others old. Richtmyer was a leader among those physicists who were concerned with the best use of our science in strengthening the nation. He knew that without the technical knowledge supplied by physics neither our industries nor our defenses could compete in the modern world. He was himself one of those far-seeing men who at the close of the last war encouraged the training in this country of a large and capable group of young scientists. Before his generation, though a few American physicists were doing good work, we were far behind our European contemporaries with regard to the number of well-

trained young men. In the development of modern physical theories, the United States had played a meager part. It was the vision and encouragement of such men as Richtmyer that brought large numbers of our best students into the fascinating studies of radiation and atoms, the result of which has been to give the supply of skilled men and women which is now our greatest source of national strength.

THE PHYSICS TEACHER'S WAR PROBLEMS

What are the distinctive problems with which the physics teacher is now faced? Let me mention a few. (1) Should we encourage our students to keep at the study of physics? (2) In teaching our students, how should the content of our courses be altered to meet the present emergency? (3) How can our methods of presentation best be adapted to present needs? (4) In a day when physics research is essential to the national defense, what should be the relative emphasis in our own work between our teaching and our technical investigations?

The broader problems also are insistent. How can physics best aid in building the nation's strength? What will be our situation when the war is over? Will our science continue to mold the development of society during the next generation as it has in the past? Let us consider these questions in order.

SHOULD STUDENTS STUDY PHYSICS IN TIME OF WAR?

I believe the statement that in this war a hundred physicists are worth a million soldiers originated in England, when it was found how important the physicists

¹First Richtmyer Memorial Lecture, presented before the American Association of Physics Teachers and the American Physical Society, at Princeton, December 30, 1941.

were in meeting the threat of magnetic mines, of night bombers and of submarines. This striking statement on calm reflection is hardly exaggerated. It applies especially to our American war effort, where at present our greatest contribution is in developing new devices for defense and offense and in supplying war materials that must be equal or superior to those used by enemies. If there is a threat of shortage of rubber, there is already an acute shortage of physicists. Thus nothing is more important in maintaining and building our military strength than the supply of an increasing number of well-trained physicists.

Emphasis on this point is being continually made in a series of editorials and articles in the *American Journal of Physics*. It is of first importance that attention to this need be kept before the students of physics, who are apt to become restless because of their desire to be of active service. It is of equal importance that our draft boards be kept aware of this situation, in order that our young men can be assigned to tasks in which their distinctive qualifications are useful.

In support of this view of the nation's need for physicists, let me refer merely to President Conant's report of the development of the Selective Service in Britain. He states that while from the beginning of the war men with scientific training were in a favored position, after the first year had elapsed, two groups, the physics and the medical students, were the only ones who were completely exempted from direct military training. This was because their professional service was so urgently needed that no time could be lost in completing their professional studies. It has become evident in the United States that a similar acute shortage of physicists is now beginning to show itself.

This, of course, does not mean that all

persons who wish to study physics should be encouraged to go ahead. It is as true now as ever that it is the superior ones who can make the important contributions. This is especially true in the research field. There is, however, also the need for men and women having practical familiarity with physical instruments to do the laboratory and field tasks. These need not always be of the top rank. But we can not afford to train numbers of inferior students at a time when our training resources are being strained. It thus becomes especially important for us to draw into the physics fold the most capable available young men and young women, and to weed out those whose promise is so low that their special training will be of little value to the nation's strength. Our college students should thus know of the nation's urgent need for high-quality physicists, even though in view of the growing shortage of physics teachers, we may need to enforce a stricter selection.

WHAT COURSES SHOULD WE OFFER?

The answer to this question is that we need persons with all degrees of training. It is true, as it has always been, that the most valuable scientific men are those with thorough technical training combined with a broad knowledge of the relation of science to technology. Persons of these qualifications are, however, necessarily rare. We must remember that in many cases special training in particular fields of physics may considerably increase the value of persons who may be engaged upon defense tasks.

Among the special fields in which we are asked to train our students have been those of the fundamentals of aviation in connection with the Civilian Pilot training, radio courses and meteorology. In these fields there are immediate applications. The present trend is apparently for more and more of the aviation training to be done directly by the Army.

The more complete meteorology courses have been concentrated in a few centers, though there remains a place in every college for introductory studies in this field. There would seem to be no adequate alternative, however, to the college training in the understanding and use of radio circuits. The demand for proficiency in such work must necessarily increase.

It remains true, however, as it has always been, that it is the fundamentals of physics which must form the basis of our instruction program. Without a thorough grounding we can supply to the nation only a half-baked group of physicists and eventually not only the students themselves but the nation as a whole will suffer. It may be complained that time is too short for such thorough training. To this the answer is that our struggle is not one of a year or two years, it is a struggle of a generation. At the moment we must rely upon those already trained for our scientific leadership. If, however, a continual supply of fully trained men is not available, it is inevitable that, as a nation, we shall decline.

In the preface to his book, "Introduction to Modern Physics," F. K. Richtmyer presented his view of the importance of a thorough understanding of the background of physics.

The author (in his teaching of physics) has attempted to present such a discussion of the origin, development, and present status of some of the more important concepts of physics, classical as well as modern, as will give to the student a correct perspective of the growth and present trend of physics as a whole. Such a perspective is a necessary basis—so the author, at least, believes—for a more intensive study of any of the various subdivisions of the subject. An account of modern physics which gives the *origin* of current theories is likely to be quite as interesting and valuable as is a categorical statement of the theories themselves. Indeed, in all branches of human knowledge the "why" is an absolutely indispensable accompaniment to the "what." "Why?" is the proverbial question of childhood. "Why?" in-

quires the thoughtful student in classroom or lecture hall. "Why?" demands the venerable scientist when listening to an exposition of views held by a colleague.

It is only upon those with this thorough grounding in why things happen that we can rely for our future scientific leadership. Rather than to omit such thorough studies, should not the effort be made rather to encourage our students to redouble their efforts to complete their college and graduate training as rapidly as is consistent with thoroughness?

NEW METHODS OF PRESENTATION

There never was a time that called for more skill and care in teaching than now when the student's and teacher's time is precious. Presentation of our material in a form that can be clearly and quickly grasped is our part of the common task. Fortunately, the increasing familiarity of our students with mechanical and electrical devices is a help. The importance of physics in the war is likewise an asset in favor of the student's interest. We can call attention to the fact that success in his task is essential if a student would play his part in the national war effort, and that such success is measured by his classroom achievement.

The war supplies us with many devices that illustrate the principles of physics. It is clear that we shall want to make good use of these examples.

TEACHING VERSUS RESEARCH

Each of us at this time is asking himself, "At what task will my effort count for most?" Many who have been in our classrooms have become research physicists or engineers or physicians, who in their everyday service make use of what we have taught. To others, our instruction has, we hope, opened a broader understanding of the world and an appreciation of the scientific method of

thought. Through all these students, the physics teacher can pride himself that he has contributed to the nation's strength. There is, however, the natural yearning by each of us to do something directly, and a dissatisfaction with what seems to be a routine job.

Is not the answer to this problem that in whatever physics task we find ourselves engaged, we can be confident that we are contributing to the total strength of the nation? We want, naturally, to assure ourselves that our task is an essential one; but who would say that the physicist who develops an important application of electric waves that may be useful in war communication, is performing a more valuable function than the man who trains the physicist who can do this and a thousand other tasks. Some physics teachers will be qualified for specific problems of research. They are fortunate. We shall give them all possible aid. If they are, however, drawn from their classrooms, their places will need to be filled by others who may have different specialties. All of us will need to work at maximum capacity.

PHYSICS AND THE NATION'S STRENGTH

Before this group it is not necessary to elaborate upon the many ways in which physics can be applied to the national defense. The demand for more physicists speaks for itself. Others can tell better than I what is being done. Much of the story must wait until the war is over.

Let me note, however, that urgent as is the present emergency, our task is to strengthen the nation for many years to come. We are confident of victory; but win or lose, the struggle will continue for decades, perhaps generations. For rival ideas, as well as rival armies, are at war. Defeat of the Axis armies will not mean that the national gods are destroyed, that nations will no longer seek

prosperity by trying to enslave their neighbors. It will remain necessary for those who work for human welfare to demonstrate that in a free society useful knowledge can grow and can be directed to the common good.

The vaunted efficiency of the totalitarian régime has at least supplied us with an example of how not to prepare for the future. In 1939, before the war, in their concentration of effort on building a war machine, Hitler's Germany virtually eliminated theoretical physics from university instruction, because it was useless for the country's fighting power. The number of students of technical physics had fallen to a fourth of its peacetime level, because of the demand for military service. Already at that time the shortage of technical men was felt, and training was retarded. One can hardly imagine that this deficiency has been rectified in the last two years. The result is inevitably a future Germany that will be at a disadvantage in technology when compared with its neighbors, unless after the war technically qualified men should be imported on a large scale.

By contrast, it is clear that if America wishes to maintain leadership in a society based on technology, the continued and increased training of physicists is essential. In time of meat shortage we must grow more cattle, not kill off those we have. When physicists are scarce we must intensify our training program. Those of us who remain in the colleges must perforce do double duty; but it will be a national calamity if our numbers are so greatly reduced that adequate teaching can not be carried on.

WHAT LIES AHEAD FOR PHYSICS?

The students that we train ask us, "What of our future?" They remember the depression, when physicists were unwanted. Now they see an intense demand. Some will be employed in the

war, but many can not expect to complete their preparation before the war is over. Then what?

You will recall that after World War I our universities doubled their enrolment. This was because the value of education had made itself evident to all the young men who were in the fighting. Chemical industries, newly established to meet the stoppage of German exports, drew thousands of young men. The close of that war meant the beginning of a new opportunity for America's chemists and engineers.

How then after the present war? President Conant, himself a chemist, remarks that this is the physicist's war. Never before has physics been in so favorable a position to demonstrate its effectiveness—and the demonstration is impressive. The outcome of this work must necessarily be the introduction of more physical techniques in industry. Leaders in the current developments will be found in high places. As chemists in industry now seek young chemists to do new jobs, so as more physicists assume leading industrial positions, we may expect more young physicists to be called for. At the moment, at least, the trend is toward further emphasis on the physicists role.

There is, of course, the possibility—some say the inevitability—of a post-war depression. If this should occur, my guess would still be that the physicist will feel such a depression less than those in other professions, for the reason just given, that our work is playing a rapidly growing part in the nation's life.

Professor Sarton tells how the continual growth of science forms the main line of man's gradual development

toward more complete humanity. The growth of physics through which we are living, is a clear example. We learn the laws of heat and of electricity, and steam and electric power transform our world. We discover electrons, and the radio broadens our outlook. Nuclear physics takes its place and dreams of a life based on atomic power arise ever more clearly before us.

To make use of these developments, society has to become more highly organized. We depend upon each other more and more as our work grows more specialized. Willingness to work together is needed in the new society. Modern physics thus forces man to become more completely a social being.

It is a corollary that disorganization creates greater havoc than in a pre-technical society. Our national strength grows greatly as we unify ourselves to meet a threat from without; but a world disorganized by war can not function smoothly, and all mankind suffers. The science which leads toward a unified world thus makes war a greater disaster. It is such a threat that must make men learn to solve their problem without war.

According to ancient legend, Daedalus with his newly invented forge fashioned a steel sword which he presented to King Minos. "Alas," said the people, "this sword will bring us not happiness, but strife." "'Tis not my purpose to make you happy," replied Daedalus, "but to make you great."

Thus it is that physics, giving vast new powers to man, is challenging him to shape his world on a more heroic scale. It is great to be a physicist in days like these. God grant that men may learn to use wisely the mighty sword that Daedalus gives.

BOOKS ON SCIENCE FOR THE LAYMAN

THE PROGRESS OF MEDICINE¹

THAT there should be a steady and insistent demand from the laity for books on medical topics is not strange; every one has a body, and has a vital interest in knowing how it functions and how disease may be avoided. All too often writers take advantage of this interest to palm off inaccuracy, one-sidedness or downright quackery on an unsuspecting public, to the dismay and chagrin of the medical profession and to the confusion of the laity. When, therefore, a thorough, accurate and readable book on medicine appears, there is cause indeed for rejoicing.

Mr. Gray is an experienced writer on scientific matters. He grasps the subject, learns the details and then presents it in such a way as to hold the attention and make the facts clear. To quote the author: "This book is not a compendium of medical lore, or a guide to modern research, or a treatise on cures. It is simply an effort to convey an impression of what medicine is trying to do, of the standards and procedures with which it works, and of the achievements, the problems, that are engaging the attention of the men of the laboratories and those in the clinics." The three main fronts along which medicine has advanced in this century, says Gray, are infectious diseases, endocrine (ductless gland) disorders and nutritional deficiencies. We find, of course, a chapter on vitamins ("The Five Aliments") and one on sulfanilamide, that almost magical drug. Two are devoted to the constitution and diseases of the blood ("The Sea We Live in" and "Bleeders and Clotters"), two to mental disorder ("Anxiety" and "Brain Storms"), one to cancer, one to alcoholism and one to

¹ *The Advancing Front of Medicine*. George W. Gray. viii + 425 pp. \$3.00. November, 1941. Whittlessey House.

the effects of tobacco smoking. The physiology of sleep is discussed, as are the nature of pain and the process of aging.

In the preparation of each chapter, Gray consulted the leading specialists in the field and studied the literature carefully. Chapter and verse, or at least the book, are given for nearly every statement, but not in pedantic footnote form. The fact that differing views are held on some topics is not blinked by the author; he does not oversimplify, and he avoids dogmatism, that bane of the scientist. His fine sense of balance is indicated in his closing chapter:

"Health does not fall like the gentle rain from heaven—not in our complex civilization of speeding motors, invisible viruses and other germs, highly sensitized tissues, dysrhythmic brain waves, disordered body chemistry, and the constant fear of 'what will people say?' When to these ingredients you add slums, idleness, vice and finally the ultimate flowering of human stupidity, war, you arrive at a recipe for disease that is universal. It can produce anything listed in the pathology books—and does.

"The public health movement has demonstrated that cities, states and nations can lower their disease rate and lower their death rate by taking thought of the preventive measures against disease and taking action to enforce them. The same principle applies to the individual."

To every one who desires a survey of the advances made by medicine, with all that they signify for health and happiness, the volume can be heartily recommended as sound, comprehensive and balanced. Mr. Gray has rendered a valuable service to medicine and to intelligent readers.

WINFRED OVERHOLSER, M.D.

BRAIN STORMS¹

THE older conventional conception of mind and matter as two distinct entities almost unrelated to each other has given way to recognition that "mind" is a functional expression of the organic structure of the brain. The demonstration in 1929, by Hans Berger, a German psychiatrist, that enormous amplification of the electrical currents of the brain makes possible the detection of these currents and the recording of the various impulses, has stimulated much research into this field. The pattern of electroencephalographic tracings has been found to be fairly characteristic for each individual, and certain mental and/or nervous disorders likewise give rise to changes in these patterns which are of considerable diagnostic value. As is true on the appearance of any and every new instrument of precision, there has been more enthusiasm in the application of the new technique than judgment in the interpretation of the observations. Though much has been learned concerning the significance and mechanisms of these "brain waves," far more factual information is necessary before their interpretation is scientifically sound. This spearhead in the advance of science has not yet "consolidated its gains."

The electroencephalogram has been applied most extensively to the study of epilepsy. In the detection of asymptomatic or "potential" epilepsy, the method is of proven clinical value and is of great service in aiding in the selection of candidates for training as air pilots. Dr. William G. Lennox, of the Harvard Medical School, has for many years been interested in epilepsy, and now in a new and most interesting book attempts to explain to the layman the phenomena of this disease. In attempting this Dr. Lennox is very brave and ambitious, but one questions his wisdom.

¹ *Science and Seizures*. William G. Lennox. Illustrated. xlii + 258 pp. \$2.00. 1941. Harper and Brothers.

The subject is so ill understood by even the most advanced students thereof, it is so extremely technical and requires such an extensive foundation knowledge of psychiatry, the anatomy, physiology and chemistry of the brain and involves so many diverse and variable etiologic factors that the layman is much more likely to be confused than soundly instructed. The book is meant, apparently, for both popular and medical consumption. For the latter audience it is a stimulating monograph discussing theoretical and controversial concepts. The lay reader will be left puzzled or actually misled by the implications of specificity and finality of the Berger rhythms.

However, the severest criticism of this book, which is well written, interesting and full of thought-provoking concepts for the critical physician, professional psychologist or biophysicist, is that Dr. Lennox links migraine with epilepsy. Some fifty years ago Gower, the great English neurologist, stressed the association of the two disorders, pointing out that both have hereditary factors in their etiology, that both are paroxysmal in character and that the attacks of both are preceded by aura or subjective warnings. But there the associations stop. Migraine is a functional disorder of the vegetative or sympathetic nervous system; epilepsy is a disease of the brain. Epilepsy ultimately leads to mental deterioration; migraine, on the contrary, is far more frequent among those with especially effective minds. The reviewer has yet to meet a stupid migrainic, although he has seen many with untrained minds as well as many more with truly brilliant intellects. Epilepsy is progressive; migraine is not. There are many more wide and significant differences which make the association of the two disorders scientifically unsound. It would be equally logical to associate hay-fever with epilepsy, for in many individuals the migrainic attack is an expression of an allergic reaction. To relate migraine and epilepsy in the

lay reader's mind is not only wrong, but downright dangerous and destructive. Physicians know the incongruity of such association, but the lay reader, without clinical knowledge, is uncritical, unprotected and gullible. To encourage misleading the gullible is unwarranted, no matter how well the book may be written nor how stimulating are the theoretical hypotheses presented. The migrainic has a sufficiently heavy cross to bear with adding the damning and erroneous insinuation that his or her disorder is related to epilepsy and is a sign of constitutional inferiority. Just because the migrainic individual is more vulnerable to the effects of fatigue than are other types, is it logical to classify him as constitutionally inferior? A blond is more vulnerable to the actinic rays of sunlight, and blondness is hereditary. We can not, however, say that blondness is therefore related to a disease of the brain. The greatest obstacle to effective clinical management of migraine is the habitual discouragement of the patient as a result of repeated frustrations of ambition due to the susceptibility to fatigue. Nausea is the most discouraging symptom of them all. It is feared that by adding unwarranted discouragement the present volume will do more harm than good.

EDWARD J. STIEGLITZ

AN AMERICAN DOCTOR IN AFRICA¹

AFTER two weeks on a river launch, the author traveled in canoes on streams walled by jungle "as monotonous as spinach," yet filled with variety and interest for such an observer as Davis, who found charm in everything—the rhythmic strokes of the paddles and the chants of the paddlers—"Oh, the white man sits back while the black man paddles."

He was going to the medical mission station to spend ten years as doctor for countless souls who would otherwise have

¹ *Ten Years in the Congo*. W. E. Davis. xv + 301 pp. \$2.50. March, 1940. Reynal and Hitchcock.

no doctor at all, in an area the size of Connecticut. In his last year there, 65,000 patients came to the dispensary to be treated, and he himself performed 536 major operations. His patients had yaws, sleeping sickness, venereal diseases, leprosy, tropical ulcers, hernias, elephantiasis, abdominal tumors, goiters, broken bones, bladder stones and bad teeth. They were all infested with worms, intestinal or otherwise, and they got fish bones in their throats, were bitten by crocodiles and snakes, clawed by leopards, and cut up by each other. They suffered also from lice, from itch, indolence and indigestion—dirt, dysentery, dermatophytosis and the devil! Cancer, appendicitis, gall stones and typhoid fever he did not find. Usually the patients came after their own witch doctors had failed, and the cost of administering the magic needle with a dose of neosalvarsan for yaws was fifteen cents—providing the patient had the money. During spare time, inspection trips were made, usually by bicycle, to villages in the province.

The title, "Ten Years in the Congo," is unimpressive. Many people have lived there longer than that and learned less than Davis, and are less fitted to tell what they did learn. An ex-marine, tire salesman and student, he had had dreams of working his way around the world. Instead, he took a course in medicine for service in China, but *the girl* was located in Africa, and there he went.

A keen observer, as well as a hard worker, he has written of native life, the lives of the Belgian officials, in addition to his own work and that of his colleagues. He found time for an occasional hunting trip. He killed his elephant. His notes on the large creatures of the forest and the smaller ones of the household are interesting reading.

The author seems to know Africa and the Africans inside and out. His life in the jungle and his work, both of which he loved, make a delightful narrative.

W. M. MANN

THE BEHAVIOR OF TERNS¹

POSSIBLY because of the social implications of colonial living and its parallel in human societies, the behavior of gregarious nesting birds has come very much to the front in recent studies. Another reason for this trend is undoubtedly the abundance of material within a colony: if one nest meets with disaster, the season's work is not lost, as there are many others for the observer to watch. Ralph Palmer's work on the common tern, here under review—is the latest instance of this type of study. The work was done in Maine, chiefly on the Sugarloaf Islands, near Popham Beach, Sagadahoc County, and the material was ample—about 750 pairs of common terns were nesting under his observant eyes.

By means of lettered or numbered stakes, individual nests were marked; by banding, by marking with quick-drying paint and by gluing bright feathers to their rumps, many birds were individualized for observational records. The actual observations were made from blinds at very close range, and the birds were disturbed as little as possible.

The first part of the report deals with the environment of a tern colony, the second with the behavior of the birds during the breeding cycle. The author finds that isolation is a primary requisite for a successful colony and that this is coupled with the need of an adjacent source of food (chiefly sand lances and small herring). From the behavioristic standpoint, it is necessary for the nesting birds to react as a unit and, accordingly, to see and hear their neighbors. Therefore, too high or too dense vegetation would act as a barrier to a colony. Even in successful colonies, the author estimates that not over 35 per cent. of the chicks that hatch survive until winter.

There are very narrow limits to the

¹ *A Behavior Study of the Common Tern.* Ralph S. Palmer. Illustrated. 119 pp. \$1.00. 1941. The Boston Society of Natural History.

optimum environment of the common tern, which, like other species of terns, seems to be overspecialized, lacking the stability of gulls in the face of environmental change. The common tern is rigid in its behavior pattern, and it seems that most of the behavior exhibited is derived from two basic posturing positions. One of the functions of formalized display before the time of laying is to synchronize the breeding cycles of mates. They are not "in tune" from the beginning. Apparently the males are at least psychologically not ready to copulate, except for short periods, although the fact that males can be induced to do so after the loss of the first clutch would indicate that they may be physiologically ready to do so for a considerable period of time.

The whole report is of unusual interest and constitutes a real and important addition not only to our knowledge of the common tern, but to our understanding of bird behavior in general.

H. FRIEDMANN

PSYCHIATRY FOR THE LAITY¹

THIS little book of one hundred forty-eight pages is a psychiatric text-book written for the laity and quite free from technical terms. It is graphically illustrated and there are many simple examples and comparisons which remove a great deal of the mystery usually associated with mental illness.

The first few chapters of the book are devoted to an explanation of behavior and the reasons for particular types of behavior. The terms conscious and unconscious are defined and those particular periods of life during which mental illnesses tend to occur are discussed.

The last half of the book is devoted to a discussion of the types of behavior encountered in the psychoses, and their relation to normal behavior is carefully

¹ *Psychiatry for the Curious.* George H. Prentiss. x+148 pp. \$1.50. 1940. Farrar and Rinehart, Inc.

explained. The importance of early treatment is emphasized and the various forms of therapy employed in the treatment of mental diseases are explained.

This book is ingeniously written and very interesting. It is to be recommended to the medical profession as well as to the laity in general to whom it is especially directed. Furthermore, it is an excellent book to recommend to those of the general public who are confronted with the problem of mental illness in their families or friends.

EVELYN B. REICHENBACH

A CHRISTIAN LOOKS AT PSYCHIATRY¹

THIS little book, written by the student counselor at Walla Walla College, offers an unsystematic discussion of various mental hygiene problems. Its orientation is Christian, its tone inspirational. Jesus is called "the greatest of the world's psychologists and mental hygienists" and His teachings "the standard and norm of mentality." While the author appears to have some knowledge of experimental psychology and a passing familiarity with various neurotic syndromes and their meaning, as escape mechanisms there is much that is outmoded and unsound. Thus there is a great deal of discussion about nerves "wearing out," "over-straining our nerves," and "nervous fatigue"; the progressive loss of intellectual ability with increasing age is denied; and the treatment of extroversion and introversion does not go beyond James's distinction between the "tough" and "tender" minded. There is nothing to indicate that the author has ever heard of psychoanalysis either as a theory contributing to our understanding of neurotic conflict or as a form of therapy. Scientifically

¹ *How Your Mind Works. A Handbook of Mental Hygiene.* Gwynne Dalrymple. 160 pp. \$1.25. 1940. Pacific Press Publishing Association.

weak and even fallacious though it is in spots, the book contains much homely, age-old wisdom about essential values and it may therefore help some, who can accept the religious frame of reference, to meet more serenely the conflicts and frustrations which confront them in everyday life.

ISABELLE V. KENDIG

FROM CANDLE TO FLUORESCENT LIGHT¹

THE director of the Lighting Research Laboratory of the General Electric Company here presents his twenty-first book on light and lighting for laymen. It is a history of the development of lighting from ancient times to the most recent. Like all Dr. Luckiesh's books it is easy to read, full of wise comment and philosophy, and a superb exposition of modern practice. "Illuminating" would be the word for it, with the author himself a luminary of the first magnitude.

The first hundred pages are historical and social, the record of man's progress toward civilized living by coming indoors and into the glow of candles, lamps and matches. Another fifty pages are given to gas lights, electric arcs and glowing filaments—the era just closed or closing. The last 120 pages are the exciting story of to-day's innovations which are as yet not appreciated by the public, certainly not as the beginning of a new era of civilized living. These seven chapters discuss luminous vapors, fluorescent light sources, lighthouses and beacons, the art of lighting and illumination and artificial sunlight.

The theme of the book, as of the whole world of research from which it springs, is that the conquest of darkness is easy nowadays, but is not enough. The true purpose of artificial light is to compete with daylight, to challenge the sun itself.

GERALD WENDT

¹ *Torch of Civilization.* Matthew Luckiesh. xvi + 269 pp. \$3.00. 1940. G. P. Putnam's Sons.



SIR WILLIAM BRAGG

—Underwood & Underwood

THE PROGRESS OF SCIENCE

SIR WILLIAM BRAGG

THE last two or three years have dealt heavily with those outstanding figures of science whose names will be forever linked with the greatest period of transition in the whole history of knowledge. Speaking only of those of English lineage we have, first, Lord Rutherford; then his old professor, Sir J. J. Thomson; next the oldest of them all, Sir Oliver Lodge; and now the Reaper of the Ages has gathered Sir William Bragg to the halls of the illustrious dead.

There are times in the progress of science when, mystified by a galaxy of discoveries which seem to change the face of nature, the student of philosophy feels anew the urge to believe that at last the secret of the universe has become unveiled and that the time has come to write a constitution thereof which shall be a perpetual guide to the thinking of mankind. The great discoveries of Faraday, Henry, Maxwell, Lorentz and Kelvin had promised well to supply the missing bricks to complete that great cathedral of knowledge whose foundations were laid by Newton and Galileo. So profound was the respect for this edifice, which seemingly was so near completion, that any novice in the workshops of the architects, who dared to add designs which were in any way out of harmony with the structure so far envisaged, was apt to be subjected to the paternal frowns of many great men who had earned the right to frown, and to be intimidated into an inferiority complex.

However, progress is no respecter of the might of the past, and the turn of the new century was to see many new things which staggered the imagination of even the radicals in the physics of the day. It fell to the lot of Bragg to become involved early in his scientific career in some of the most startling of those discoveries in x-rays which refused

to fit in to the all but universally accepted order of things. Bragg felt keenly the necessity of invoking a new concept as to the nature of x-rays, a concept apparently completely out of harmony with the classical views. C. G. Barkla was the warrior who championed the old cause; and for many months *Nature* presented in each issue some new argument by one of the advocates as to why one view was right and the other was wrong. This discussion did much to clarify the picture and helped in the final consolidation of our views to a stage in which it was possible to consider that neither view was absolutely right and neither absolutely wrong.

In a less spectacular realm, Bragg contributed much to the then new science of radioactivity, but his x-ray researches were destined to find a new development and a new richness when x-ray spectroscopy was born. A cynic of the period might have found much to whet his sarcasm in contemplating the poetic justice of the situation in which Bragg was to find in the waves which he had fought so strenuously slaves who turned the other cheek to his assaults and combined by their services to contribute perhaps the greatest laurels of his career. In this very service, however, these waves and their rivals, the particles, found new bases of harmonization which ultimately approached logical form in the modern wave-mechanical theory.

Much of the work in x-ray spectroscopy was done by Sir William Bragg in close collaboration with his son, William Lawrence Bragg, now Lord Rutherford's successor at the Cavendish Laboratory, and by the combined efforts of father and son a new attack upon the structure of molecules and groups of molecules was developed to the stage of power and usefulness.

William Henry Bragg was born on July 2, 1862, at Wighton, Cumberland, England. After attending King William's College in the Isle of Man, he went to Trinity College, Cambridge. In 1886 he was appointed professor of mathematics and physics at Adelaide, South Australia, and in 1909 he returned to England as professor of physics at the University of Leeds. He was appointed Quain professor of physics in the University of London in 1915, and in 1923 he became Fullerian professor of chemistry at the Royal Institution and director of the Davy-Faraday Research Laboratory. During the First World War he acted in an advisory capacity to the British Admiralty and was created K.B.E. in 1920. Up to his death during the present war, he was again engaged in the services of the government. Sir William Bragg received the Nobel Prize in conjunction with his son in 1915. He received many honors, among them the Order of Merit, the Barnard Medal, Columbia University, and the Franklin

Medal of the Franklin Institute. He served as president of the British Association for the Advancement of Science and as president of the Royal Society of London.

Sir William was noted for the clarity of his lectures and of his writings; and he has done good service for the layman in being responsible for two books of a popular nature entitled: "The Universe of Light" and "Concerning the Nature of Things."

Sir William Bragg married Gwendoline, the daughter of Sir Charles Todd, in 1889. Lady Bragg died in 1929, preceding by thirteen years her husband, who died at the age of 79.

Sir William was noted for his kindly disposition and his courtesy to all. He was one of the best loved and respected of the world's men of science, and his death has brought sadness to many a heart.

W. F. G. SWANN

BARTOL RESEARCH FOUNDATION OF
THE FRANKLIN INSTITUTE,
SWARTHMORE, PA.

AFRICAN PLAINS EXHIBIT OF THE NEW YORK ZOOLOGICAL PARK

ALTHOUGH the Zoological Park in New York has long been renowned for the extraordinary variety and unique character of its animal collections, it has been no secret that some of the physical methods of exhibiting these great collections have left a good deal to be desired.

During 1939, when a modernization program was first decided upon, consideration was of course first given to the methods to be employed. Two general principles were adopted. First, that the moated or barless enclosure should be used to the greatest extent possible. Second, that much emphasis should be placed on showing groups of animals in free areas according to their continental habitats rather than by orders and families. It was believed, in other words, that the public would gain a far clearer conception regarding animal life were

the collections exhibited in so far as possible in their natural environment and, further, grouped together as in nature in order to indicate the social interrelationships of various species. The advantage to the animals themselves was apparent.

While the new African Continental Exhibit represents a definite step forward in the art of exhibiting wild animals, recognition must be given to the excellent techniques developed by other zoological parks, both here and abroad, in the use of barless and moated areas and of naturalistic backgrounds. We are greatly indebted to the managements of some of the other larger zoos in this country for the collaboration extended to us in the preparation of our plans.

We determined to provide the public with as much information as possible



LOOKING ACROSS THE AFRICAN PLAINS AT THE BRONX ZOO
TOWARD THE LION SHELTER HOUSE. THE WATER HOLE IS IN THE CENTER.

regarding what might be termed the background, the story, let us call it, of the animal itself, of its derivation, even of its evolution. Consequently, at the entrance to "Africa," four large diagrammatic maps have been placed which present the remarkable development of life-forms, as they are known to have occurred in the Age of Reptiles, subsequently in the Age of Mammals, then in the Post-glacial era and finally the animal life of to-day. The last-mentioned map suggests as well some of the topographical and climatic characteristics of the continent. Although we are not as yet satisfied with the technique employed in this presentation it is at least a start in the right direction and has aroused wide public interest.

In the early stages of planning, it was recalled, further, that a naturalist in Africa occasionally observed grazing animals and carnivores in the same scene—a plains area in the foreground on which could be seen various kinds of antelope,

zebra and other herbivores and on a rise of ground in the distance, a group of lions, sunning themselves perhaps, as if a temporary understanding existed between prey and hunter. This recollection provided us with the clue for the first two units of the African Continent Exhibit which have now been completed.

As one enters there lies before one an open area on which animals, roaming freely together, include zebra and various types of antelope, such as nyalas, impalas, elands, springboks, reedbucks, waterbucks and others. Scattered about, moving here and there, is a wealth of bird-life, including the following species: the ground hornbill, marabou stork, ostrich, secretary bird, griffon vulture, crowned cranes, demoiselle cranes and Stanley cranes. Beyond this foreground scene are the lions. The large moat between is so cleverly concealed that it appears at first sight as if all the animals including the so-called "king" are living together under a mysterious truce.



Samuel Gottscho

THE AFRICAN PLAINS AT THE BRONX ZOO
 IN THE BACKGROUND, TOWARD THE TREES, IS THE SECTION THAT LATER IS TO BE DEVELOPED INTO
 MOATED ENCLOSURES FOR ELEPHANTS, GIRAFFES, HIPPOPOTAMUS AND RHINOCEROS.



Samuel Gottscho

FIVE YOUNG LIONS AT LIBERTY ON THE LION ISLAND UNIT
 A MOAT TWENTY FEET WIDE SEPARATES THE LIONS FROM THE PUBLIC WALK AND THE REMAINDER OF
 THE AFRICAN PLAINS, WHERE ANTELOPES ARE AT LIBERTY.

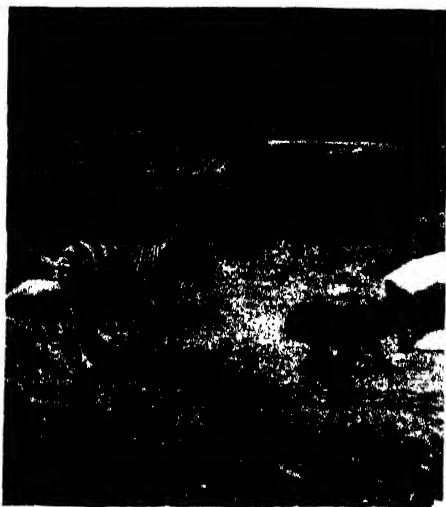

A ZEBRA ON THE AFRICAN PLAINS AT THE BRONX ZOO. THE TWO ZEBRAS THERE WERE EXTREMELY UNRULY FOR THE FIRST FEW DAYS AND CHASED MOST OF THE OTHER ANIMALS. IN LESS THAN A WEEK, HOWEVER, THEY SETTLED DOWN AND CAUSED FEW DISTURBANCES. ALL THE MAMMALS AND BIRDS FLED FROM THEM EXCEPT A PAIR OF STANLEY CRANES, WHICH BUILT A NEST AT ONE SIDE OF THE PLAINS; THE MALE CRANE, GUARDING THE NEST, FRIGHTENED THE ZEBRAS AWAY.

In general, the grouping of animals in the plains area has been successful, in so far as avoidance of accidents is concerned. Perhaps the most curious incident that happened was the fact that the lions, when first placed in their area, frequently jumped down into the moat, a drop of a sheer sixteen feet, with rough ground and broken stones at the bottom. Again it was proved how difficult it was to hurt a "cat," as none of the lions was injured. Finally their curiosity has been satisfied and they have stopped acting upon this exploratory impulse.

We are looking forward to the time when the African Exhibit may be completed. Plans have been drawn for areas for the elephant, giraffe, the primates, the rhinoceros and other major mammalian types. Eventually the public may come and see the panorama of this continent, so remarkable for the richness and variety of its animal forms. It is believed that this method of exhibition is not only interesting and beautiful, but rich, as well, in its educational values.

FAIRFIELD OSBORN

RECENT MOGOLLON DISCOVERIES

FIELD MUSEUM Archeological Expedition to the Southwest has just returned from New Mexico. The excavations were carried on in an ancient village which was occupied by people belonging to what we call the Mogollon ("muggy own") civilization. This culture has only been recognized a few years.

Approximately 600 stone and bone tools and 18,000 potsherds (broken pottery) were brought to light. These stone and bone tools are of an early type; the broken pottery is crude and undecorated. These rare specimens, together with the facts gleaned during the digging season, will be studied, correlated and reported on within the next five or six months. In the meantime, it is possible to make a few general statements and to sketch hastily the meaning of the summer's work.

Was the expedition a success? Emphatically, yes, it was. Did we bring back any showy specimens? No, we did not.

Archeology is not a search for specimens, anyhow; and emphasis on them indicates a lack of perspective of what it is all about. Archeology is, rather, a discipline dealing with man's history. We try to recover and interpret man's past; and in order to carry out this purpose we excavate. In digging a ruin in the Southwest, one finds tools of stone and bone, and generally pottery and houses. These tangible remains of the culture form the basis for reconstructing man's past—and therefore specimens are useful. It should always be remembered that probably 90 per cent. of the civilization dies when a village or town is de-

sented; for, from the dust, the archeologist can not recover the language spoken by the villagers, the dress, the social customs, the thousand and one items that make up any civilization. We can, however, by careful study and observation make guesses about the past.

Why was the Mogollon civilization and, in particular, the SU site chosen for study?

We are interested in studying the Mogollon civilization for many reasons. It represents an early stage in the development and growth of towns situated in fertile agricultural areas. The U. S. government is interested to-day in per-



—Field Museum of Natural History
EXCAVATION OF PITHOUSE

Final plan view looking approximately east, with entrance cleared, except for a section of fill within the roots of the great juniper tree on the upper left. *Note:* the double line of small post-holes in the southwest quadrant; the squared break in the circle of the big northwest sub-pit, intentionally made to test the sterile layer at ancient excavated floor level (this break was not original); the bed of gravelly hard pan which runs from the west edge out into the center of the pithouse.

suading isolated farmers to gather in central clusters or towns. Here, our modern farmers would have better social, psychological, educational environments. But to know whether such an experiment would be successful to-day, one has to study the past.

We are also interested in the religious, social and economic structures which the Mogollon Indians developed long ago; for an understanding of these fundamentals would help us understand man's eternal urge for progress and striving upward.

Furthermore—and this is what so closely links the present with the past and gives one a warm, comfortable feeling that one is not an isolated phenomenon on this globe without antecedents or successors—we are interested in showing that in spite of differences in time, climate, race and geography, men possess certain fundamental urges which cause them to act more or less similarly at all times and in all places. Thus we can easily see a sameness of development throughout all civilizations.

Therefore, our reasons for digging at the SU site are clear. We wished to learn how these primitive folk lived, how they grouped themselves socially, how they solved their economic, agricultural and religious problems, and why and how they lived in clusters of houses or villages. We desire this information because we must understand past and present man if we are to understand our civilization and help it improve.

The expedition gathered much information, some of which will be useful for helping to solve some of the problems outlined above.

WHAT WAS THE MOGOLLON CIVILIZATION?

Up to a few years ago, archeologists believed that there was but one civilization in the Southwest and that it produced all the various types of pottery, houses and tools that we dug up. We



MEN EXCAVATING ANOTHER PITHOUSE WITH THE HELP OF HORSES

now know that this notion was incorrect. Within the last few years archeologists have demonstrated that there were two other civilizations which left their mark on the Southwest. The most recently discovered one is the Mogollon civilization, towards the discovery of which the Field Museum expeditions have greatly contributed.

What was the Mogollon civilization like, and what were its chief characteristics? The Mogollon civilization was a comparatively poor one. The people of this culture lived in pithouses—which were nothing more or less than big holes in the ground and which were roofed with logs, twigs, bark and earth.

We also discovered that in addition to pithouses, these Mogollon Indians built and occupied houses, the floors of which were *not* sunk into the ground. The walls of these houses consisted of upright poles set eight to fourteen inches apart. In between these poles, mud and small sticks were placed, thus forming a good tight wall. This kind of construction is called wattle-and-daub and contrasts with the below-ground houses found on a previous expedition.

Firepits were not found in any of the houses. Therefore, we believe that these Indians rarely used fire inside the house for cooking, warmth or light. Extensive digging outside the houses likewise failed to bring to light any firepits. But large deep pits were discovered and perhaps in these barbecuing was done. Or perhaps these people did little or no cooking.

Most of the houses were equipped with large or small entrance-tunnels which always faced east. Why these tunnels faced east is not known, although probably the orientation was for religious reasons. Entrance or exit from these houses was by means of these tunnels.

Life in the underground houses must have been somewhat dark and perhaps damp and not very comfortable. Next year we expect to reconstruct a roof over one of the old pits, let it stand for several weeks, and then burn it. In this way, we shall be able to answer some of these puzzling questions.

The stone and bone tools of the Mogollon Indians were crude and unlike those which one ordinarily associates with Indians. In fact, the stone tools—



A PARTIALLY STRIPPED PITHOUSE looking approximately southwest. The apparent wall is actually humus-fill left in place during the operation of stripping, over the vertical face excavated into sterile ground by the original inhabitants. *Note:* pits and post-holes without the original excavated area of the pithouse, in the east and northeast; trace of refilled Pithouse E to north-northeast.

such as scrapers, choppers, hammer-stones, polishing stones and pestles—are so primitive that one would probably



PLAN VIEW OF A PITHOUSE LOOKING APPROXIMATELY NORTH AS ARROW AND METER STICK ARE BEING PLACED.

pass them by without recognizing that they had ever been used by human beings for any purpose whatsoever. But, finding many such stones in all the houses caused us to note that they fell into distinct patterns and types and therefore could not be natural, unused stones.

It is interesting to note that no axes of any kind were found. The absence of this important tool makes us wonder how these ancient Mogollon people felled their trees, for we know that they used fair-sized trees for roofing their houses.

BURIALS

The dead were always buried in pits, which lay outside the houses or were dug in the house floors. The corpse was wrapped in a sitting or doubled-up position and was then placed in a pit. Generally, burials were not placed in house pits until after the house had been abandoned. But in some instances, the family continued to live in the house after a burial (family member?) had been placed in a floor pit. Of course the burial was covered with earth and the floor sealed the whole thing up. Offerings to the dead were very rare. The only objects found with skeletons were tobacco pipes and sometimes shell bracelets and necklaces. Whole pottery was never found, which may be an indication that pottery had only recently been adopted by this civilization and was therefore not yet really part and parcel of it.

The human skeletons themselves were in a very poor state of preservation, while animal bones found in the same excavation level were sound and well preserved. This may indicate that the animals obtained a better-balanced diet than the Indians of that period.

FOOD

During the season, only a few projectile points (arrow- and spear-heads) were found. On the other hand, many food-grinding tools were brought to light in great abundance from all

houses. It is assumed, therefore, that the Mogollon Indians of the SU village lived mostly on berries, roots, herbs and grasses, and depended very little on hunting or agriculture. This may also be a sign that this civilization is ancient, as the people were mostly seed-gatherers rather than farmers.

AGE OF SU RUIN

The age of the houses, pottery and stone tools which Field Museum Expedition discovered at the SU village in New Mexico is difficult to determine. Dating the SU village by means of tree-rings has thus far been impossible because the rings do not fit into any known sequence.

Some light on this question can be obtained by means of cross dating or comparison of the Field Museum tools with those from other ruins.

It is known, for example, that the SU ruin is earlier than A.D. 700 because no painted decorated pottery was recovered during the season. Painted pottery occurred in that area after A.D. 700.

Conversely, although the SU village stone tools are similar to those found (in southern Arizona by Gila Pueblo) in the San Pedro time period which dates at about 3,000 B.C. to 500 B.C., yet the SU village must date *after* that period because the SU villagers made pottery while the San Pedro people did not.

Therefore, the Field Museum village was founded and occupied some time between 500 B.C. and A.D. 700.

Probably the pottery which we found is among the oldest in North America.

PAUL S. MARTIN

FIELD MUSEUM OF NATURAL HISTORY

THE NEW HIGH-VOLTAGE ELECTRON MICROSCOPE

In earlier issues¹ of this journal the remarkable properties of the electron microscope have been described and photographs taken with it have been reproduced. It has a very much higher resolving power than any ordinary microscope that has been made or can be made, for the limit to the resolving power of a microscope is half the wavelength of light, or about one hundred thousandths of an inch for the visible spectrum. The electron microscope owes its higher resolving power to the fact that it uses electrons instead of light for forming images. Its resolving power is of the order of two ten millionths of an inch, or its magnifying power is about fifty times that of the ordinary microscope.

The ordinary microscope owes much of its usefulness, especially in biology, to the fact that many specimens are partly transparent and consequently show their

interior structure to a considerable extent. The electron microscope has not heretofore had this advantage because the



THROUGH AN ELECTRON MICROSCOPE TWO PHOTOGRAPHS OF *BACILLUS MEGATHERIUM* MAGNIFIED 5,000 TIMES. *Left*: PHOTOGRAPHED WITH 50 KILOVOLT ELECTRONS. *Right*: PHOTOGRAPHED WITH 200 KILOVOLT ELECTRONS.

¹ T. A. Smith, 52: 337-341, April, 1941; J. A. Becker and A. J. Ahearn, 53: 309-324, October, 1941.

electron emissions have been nearly all from the surfaces of the objects under examination. In other words, they have behaved like opaque objects and the photographs have been in the nature of silhouettes.

Dr. V. K. Zworykin and his associates, Drs. J. Hillier and A. W. Vance, have recently announced an electron microscope that in a sense has penetration corresponding to that in the ordinary microscope. Heretofore electron microscopes have used electrons accelerated by from thirty to one hundred kilovolts. At these velocities the penetration of the electrons in organic materials is not more than about two hundred thousandths of an inch and less than a tenth of that amount

in heavy metals. But by increasing the acceleration of the electrons from fifty to two hundred kilovolts, the penetration is increased to such an extent that the electron microscope has the advantages of the ordinary microscope in addition to its much greater magnifying power.

It is not to be assumed, however, that the new electron microscope will succeed those now in use. In the first place, for many purposes the additional penetration appears to give no new information. In the second place, to use the higher voltages adds to the bulk of the apparatus, greatly increases its cost and it is more difficult to operate. But for certain special purposes it will be very advantageous.

F. R. M.

WARTIME PROGRAM OF THE NATIONAL GEOGRAPHIC SOCIETY

WAR conditions have made it necessary to curtail somewhat the scope of the joint expedition of the National Geographic Society and the Smithsonian Institution, planned for southern Mexico under the leadership of Matthew W. Stirling. For three winters Mr. Stirling has conducted the archeological studies in the State of Vera Cruz and adjacent states. This winter a smaller party under Phillip Drucker is in the field at La Venta, State of Tabasco, completing stratigraphic work which was carried forward in former years. La Venta is the site at which the expedition uncovered in 1940 five colossal sculptures in basalt of human heads, as well as massive stone altars decorated in high relief. These sculptures are attributed to the little-known Olmecs. Mr. Drucker will seek to uncover, largely through the study of pottery and figurines, additional information in regard to this people.

Studies of the Aurora that have been in progress for several years under the auspices of the National Geographic Society and Cornell University under the leadership of Dr. Carl W. Gartlein are being continued from observation posts that have been established at Cornell University, Ithaca, N. Y.; Colgate University, Hamilton, N. Y.; and Hobart College, Geneva, N. Y. Hundreds of photographs of auroral displays of numerous types have been made, many of them at the same instant from the several observation points. While making additional photographs of auroral displays that occur, Dr. Gartlein and his assistants will place emphasis on the analysis of selected photographs already made for the determination of the heights of Auroras. Another project will involve the possible correlations between auroral phenomena and magnetic and radio phenomena.

J. K.

THE SCIENTIFIC MONTHLY

MAY, 1942

THE NATURE OF COSMIC RAYS AND THE CONSTITUTION OF MATTER

By Dr. RUDOLF W. LADENBURG

BRACKETT RESEARCH PROFESSOR OF PHYSICS, PRINCETON UNIVERSITY

RECENT studies of cosmic rays have revealed the existence of a new elementary particle, the "meson" or "mesotron," of a mass intermediate between the electron and the 2,000 times heavier proton. This discovery has reanimated the old discussion about the constitution of matter.

Up to ten years ago all matter was considered to be composed of negative electrons and positive protons, carrying equal but opposite charges.¹ Most of the more conspicuous properties of matter, like color, shape or chemical reactivity, could and can still be understood to be due to the electrons that form the outer parts of all atoms and molecules. Only the weight and the radioactive properties of an atom are due to the positively charged nucleus that forms the center of the atom, holds the electrons together and compensates their negative charge. All nuclei have masses that are nearly exact integral multiples of the proton mass; and for keeping these protons together negative electrons were imagined to be distributed among them. Such composition, incidentally, would make it

¹ Compare the article by the present author in Volume 40 of this journal (pages 307-312, 1935) and the article by K. K. Darrow, "Forces and Atoms," in the recent March issue of this journal.

understandable that radioactive substances may emit electrons, as many do.

Then the neutron was discovered, a particle of about the same mass as the proton but, as the name suggests, electrically neutral. This particle is certainly a part of the nucleus, and the assumption that protons and neutrons are the only constituents of the nuclei removes many theoretical difficulties connected with the formerly assumed presence of electrons in the nucleus. The electrons have, so to say, not enough space in the nucleus; their "size" and their magnetic moment is much too large. So the positive charge number Z of a nucleus is now supposed to be equal to the number of protons in it, and the difference of mass A and charge Z determines its number of neutrons. To understand from where the electrons of radioactive atoms come, it has been assumed that the neutron is able to emit an electron and change itself into a proton—although no one has succeeded so far to prove directly the instability of the neutron. Many artificially produced radioactive atoms emit—instead of a negative electron—a positively charged electron, called positron, so that the reverse transformation of a proton into a neutron with simultaneous emission of a

positron had to be assumed also. For explaining the observed phenomena of the radioactive processes the existence of one more "elementary" particle is necessary, namely, that of the neutrino, a neutral particle of even smaller mass than the electron—although it has not been possible so far to observe it directly. It has to carry away a part of the energy set free in the radioactive process and a part of the angular momentum of the nucleus, so that the laws of conservation of energy and momentum are fulfilled. Thus we have already four or even five "elementary" particles, two heavy ones, the proton and the neutron, and two or three light particles, the negative and the positive electron and the hypothetical neutrino.

The main difficulty in the whole picture is to understand the forces that bind the protons to the neutrons in the nuclei. These forces are apparently very strong when the particles are near one another, and diminish rapidly with increasing distance between them. Hence these forces are not of electrical nature, because electrical forces are known to change less rapidly with the distance, and neutrons carry no electrical charge anyhow. A theory was developed where the above-mentioned transformation of a neutron into a proton, together with the opposite process, was supposed to be responsible for the nuclear binding and for the radioactive emission of electrons. But the forces due to an exchange of electrons between protons and neutrons are not

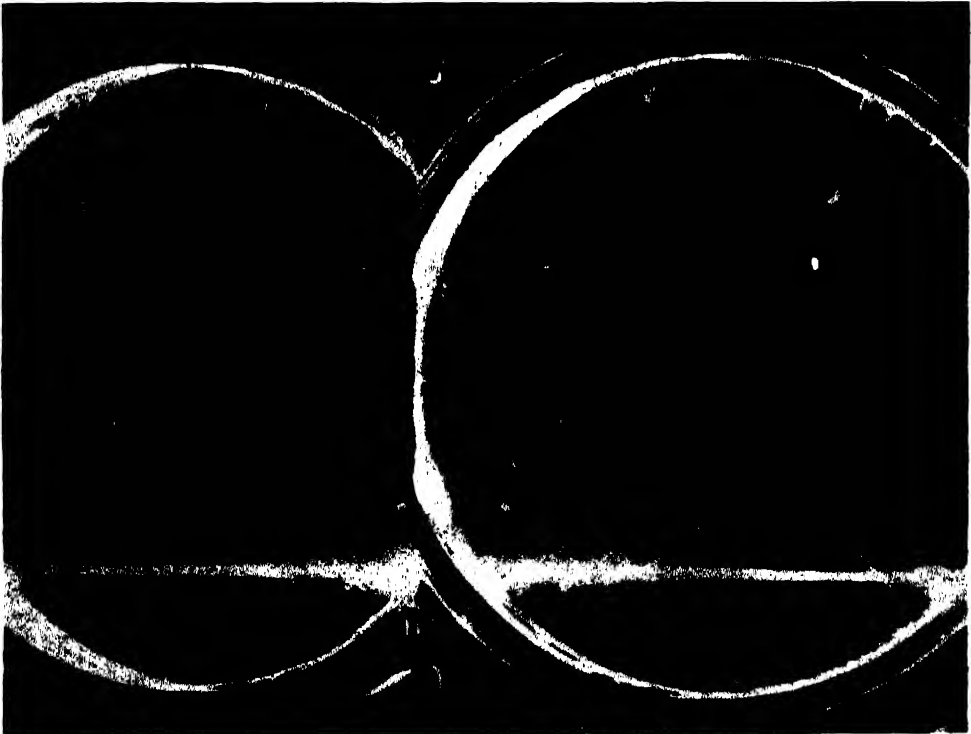

FIG. 1. CLOUD CHAMBER TRACKS

OF A PAIR OF A POSITIVE AND A NEGATIVE ELECTRON BENT IN A MAGNETIC FIELD. THE PAIR ORIGINATES IN THE GAS OF THE CHAMBER PRODUCED BY A NON-IONIZING GAMMA RAY. THE SMALL CIRCLES ARE THE TRACKS OF SLOW ELECTRONS. (FOWLER, GAERTNER AND LAURITSEN)

strong enough, the mass of the electrons is too small. That is why, in the year 1935, Yukawa introduced into the theory of nuclear forces a new particle, supposed to be about 160 times heavier than the electron, and showed that such particle could give rise to the short-range force between neutrons and protons. Two years later, such particle of about the right mass, the meson, was actually found in the cosmic rays.

These rays, discovered by Victor Hess

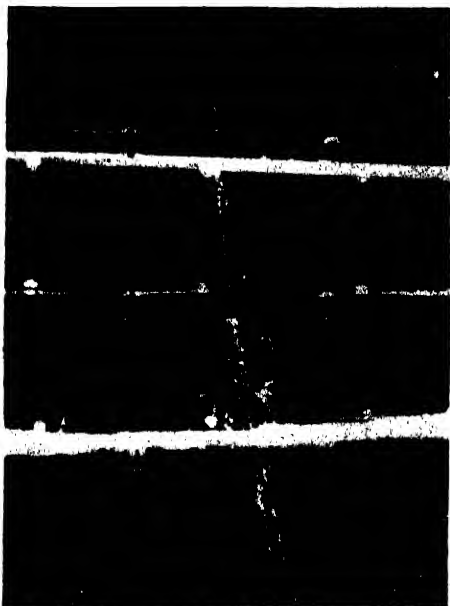

FIG. 2. A MULTIPLICATION SHOWER OF ELECTRONS DEVELOPING IN A CLOUD CHAMBER CONTAINING THREE HORIZONTAL METAL PLATES BUT NO MAGNETIC FIELD. (FUSSELL)

nearly thirty years ago, gave and give still much to think about. They come undoubtedly from outside the atmosphere as their number increases with increasing height above sea level, but they show no close relation to the position of the sun or any part of our galaxy; hence they must be of cosmic origin. They are partly uncharged photons, an electromagnetic radiation like x-rays or gamma rays of very high energy; partly



FIG. 3. A COSMIC RAY SHOWER OF MANY HIGH-ENERGY ELECTRONS INCIDENT NEARLY NORMALLY ON A 1-CM PLATE OF PLATINUM. THE CLOUD CHAMBER IS IN A STRONG MAGNETIC FIELD. (NEDDERMEYER AND ANDERSON)



FIG. 4. CLOUD CHAMBER TRACKS OF ELECTRONS AND OF ONE FAST PROTON FROM THE DISINTEGRATION OF BORON BY ENERGETIC DEUTERONS (NUCLEI OF HEAVY HYDROGEN). THE PROTON IS NOT APPRECIABLY DEFLECTED IN THE MAGNETIC FIELD. (BAYLEY AND CRANE)



FIG. 5. A MESON TRACK (*d-d*)

SHOWING SOMEWHAT STRONGER IONIZATION AND LESS CURVATURE THAN THE ELECTRONS (MARKED BY ARROWS *e*) DESCRIBING CIRCLES IN THE MAGNETIC FIELD. (WILLIAMS AND PICKUP)

they are electrically charged particles, as they are deflected by magnetic fields and behave like extremely energetic electrons and protons. But many behave differently, they penetrate, besides the whole atmosphere, hundreds of feet of water or rock. These can not be electrons or protons. Electrons even of very high energy are stopped by a few feet of water; they produce gamma rays, which in their turn produce pairs of positive and negative electrons. Such alternating "annihilation" of electrons and "materialization" of gamma rays give rise to the "multiplication showers," frequently observed in the higher atmosphere and quite often also at sea level. The instrument usually employed for studying the properties of cosmic ray, and especially of the showers, is the Wilson Cloud Chamber filled with suitable gas mixtures; charged particles produce ions in such a chamber, and small droplets condense on the ions, making it possible to see and to photograph the tracks of the particles. Fig. 1 is such a photograph. It shows the stereoscopic picture of a cloud chamber with the tracks of a pair of electrons produced by a gamma ray, which does not ionize the gas directly and is therefore not visible. The cloud chamber itself is

exposed to a strong magnetic field deflecting the electrons from their straight path in one or in the other direction, depending on the sign of their charge. The amount of curvature of the tracks in the magnetic field allows the determination of their energy.² Fig. 2 shows how the fast electrons multiply and Fig. 3 shows a shower of a great many electrons.

Protons on the other hand, because of their high mass, are not able to produce such showers; but they ionize much stronger than electrons of the same energy, since they move more slowly. Their dense tracks in a cloud chamber can easily be recognized and distinguished from those of electrons (see Fig. 4).

However, the penetrating particles of the cosmic rays give rise neither to multiplication showers nor to as dense tracks as protons, and they penetrate easily many inches of lead: these are the mesons of intermediate mass (compare Figs. 5-7).

The determination of their mass is

² Directly determined by the product of field strength and radius of curvature is the *momentum* of the particles, and if their velocity is near that of light one obtains also their energy, otherwise one has to know the mass of the particles for the calculation of their energy.

rather difficult. One has to measure the curvature of their tracks in a strong magnetic field and the ion density they produce—or better their curvature before and after penetration of a lead plate. The intermediate mass of the meson was established in this way; but the results, obtained so far, still scatter too much and are not accurate enough for determining a definite value of the mass of the meson. They do not allow to decide whether their mass is 100 or 300 times as big as that of the electron, or whether there are different mesons having different masses. It would be rather odd if there were no unique mass, and one hesitates to believe it until more exact experiments give definite proof.

Another important question is whether the meson of the cosmic rays is actually the particle responsible for the nuclear forces. If it is, it has to be unstable according to the theory and has to change somehow into an electron, as only electrons are emitted in radioactive processes. As a matter of fact, such instability of the cosmic ray mesons and their transformation into electrons has been observed and their lifetime has been determined to be of the order of one or two millionths of a second. Consequently, the mesons can not be the primaries of the cosmic rays as they come from far outside of our earth, they would have disappeared, respectively, they would have been trans-

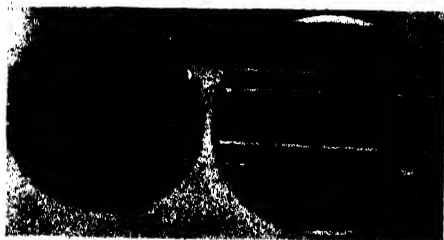

FIG. 6. TWO PICTURES OF MESONS PENETRATING METAL PLATES WITHOUT PRODUCING SHOWERS. MESONS EASILY PIERCE LEAD MANY INCHES THICK. (ANDERSON)

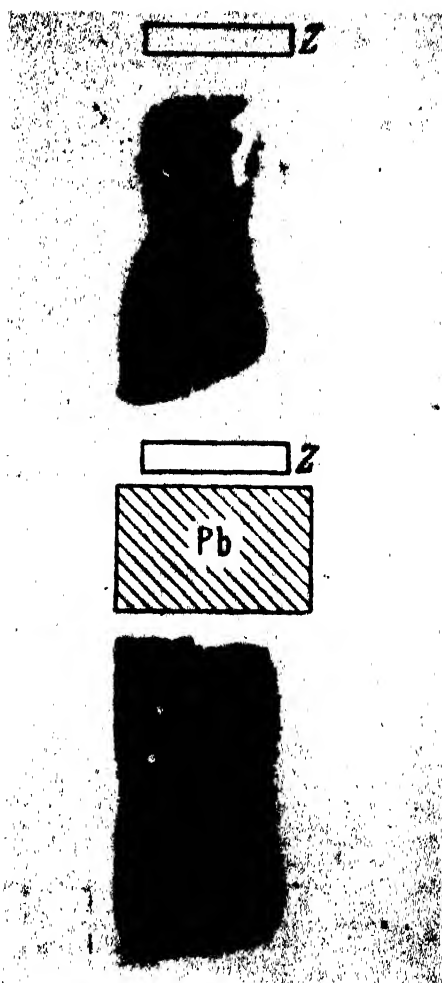

FIG. 7. TRACK OF A MESON IN TWO CLOUD CHAMBERS MOUNTED ABOVE EACH OTHER. THE PARTICLE PENETRATES A LEAD PLATE OF SIX-INCH THICKNESS BEFORE ENTERING THE SECOND CHAMBER. (EHRENFEST, JR.)

formed into electrons before reaching our atmosphere. We know that the primaries of the cosmic rays are charged particles, deflected by the far-reaching magnetic field of the earth; for the cosmic ray intensity changes appreciably with the magnetic latitude; and their East-West asymmetry proves that they are mostly, if not all, charged positively.

Recent studies with counters and other instruments carried up to the highest mountains and in balloons to heights of a hundred thousand feet have shown that mesons are generated in the atmosphere, and that probably heavy particles, protons or even heavier ones, are the primaries. These produce by their collision respectively by their electromagnetic interaction with the molecules of the atmosphere, directly or indirectly, the mesons, the electrons, the gamma rays and the showers that we observe as cosmic rays.

But the origin of the primaries of the cosmic rays is still a great puzzle. We do not know the processes responsible for the production of such immensely energetic particles. Some of them carry a million times more energy than the

most energetic particles we can produce artificially. And as to the question of the constitution of matter our answer is still rather incomplete. We know that all matter consists of atoms, that the atoms consist of tiny nuclei surrounded by electrons and that the nuclei consist of protons and neutrons. There must be strong forces acting between the protons and neutrons holding the nuclei together. But we do not know what they are. They are not of electrical nature as we have seen, and many theories have been tried for understanding these forces. The discovery of the meson in the cosmic rays has raised some hope for reaching the goal, but this fundamental problem is still far from being solved.

The more science progresses the more new problems arise.

THE DEATH OF THE GAMBIAE

IN the last number of this *Review* it was reported that no evidence of the presence of the *Anopheles gambiae* mosquito had been discovered in Brazil during the final forty-seven days of 1940. It will be remembered that this was the mosquito which, imported from Africa by airplanes or fast navy destroyers, had been responsible for a widespread and devastating malaria epidemic. As a malaria vector this mosquito was more efficient than any anopheline indigenous to America, and its further spread was greatly feared. Over 12,000 square miles of northeastern Brazil became involved; more than \$2,000,000 was spent and an army of over 2,000 trained workers was mobilized, under the leadership of Dr. Fred L. Soper, of The Rockefeller Foundation, to attack the invaders.

A year ago we reported that it no longer seemed rash to speak of the eradication of *gambiae* from Brazil, although some mopping-up operations might be necessary if any areas became infested at the onset of the rainy season in 1941. It is a satisfaction to report that no such infested areas were discovered during the entire year. Except for a short period of two months in a small area in which infestation was first found in October, 1940, no control measures were carried out during the year in the *gambiae*

region, and a free opportunity was thus afforded for any remaining members of the species to increase their numbers at will. Thorough search by well-trained and selected personnel throughout the entire area of previous infestation, and even far beyond the old limits, failed to reveal the presence of a single *gamb.ae*.

This particular battle would seem to have been won—at great labor and cost, and after enormous suffering. But the *gambiae* mosquitoes have apparently not given up their intention of establishing themselves in the Western Hemisphere. Airplanes are crossing the Southern Atlantic with increasing frequency, and commercial planes, of course, are now carefully fumigated, both after they leave Africa and again before their passengers are discharged in Brazil. A dead female *gambiae* was discovered after fumigation in a plane arriving in Brazil in October, 1941, and two more in January, 1942. The original infestation, with all its subsequent miseries, could readily have been started by a single fertilized female. Truly the price of liberty, as far as this malaria-carrying mosquito is concerned, is eternal vigilance.—Raymond B. Fosdick in "The Rockefeller Foundation *Review* for 1941."

AN ANTHROPOLOGIST IN RUSSIA

III. IN MONGOLIA

By Dr. A. HRDLIČKA

CURATOR OF PHYSICAL ANTHROPOLOGY, U. S. NATIONAL MUSEUM

FIELSTRUP, the young student I engaged at Petrograd, has joined me at Irkutsk, brought all the baggage, and will now be my companion.

At Khiakhta, an important Russian boundary station, reached after a long but uneventful boat trip on the Selenga River, engaged a man to take us in his "troika" to Urga. Had to take what could be had, for but few knew the roads and none were inclined to risk the journey. On August 31, after all sorts of preliminaries and with the generous help of the Russian boundary "komisar," Colonel Chytrovo, who even urged on me an old army gun and a bag of ammunition against bandits, we started for Urga. Our outfit—one horned-toad (the best term that fitted his disposition) driver; one time- and road-worn "troika" (springless, hard, half-open cart, pulled by three horses); a layer of hay inside the cart instead of seats; and in the none-too-large inside also a provision box, with a ham, cheese, bread and suchary (dry biscuits), my two rain-coats, my "spalny mishok" or a Russian officer's bed-roll which I got at St. Petersburg, a blanket, cushion, some clothes of my companion, a light satchel with the smaller camera, two boxes with plates and the larger camera. A bag of oats was placed crosswise in the back and another in front. The bed-roll came between the two of us, the satchel in the back, Fielstrup's blanket, etc., and my coats were spread over the bed-roll, the food box had to get out and was tied in the front next to the driver, while the two heavier boxes were fastened on the projection of the rafters in the back of the cart, the driver added an old bag

filled with his own provisions and a few lengths of old rope, the gun was placed along the side of the car—and all was ready. We climbed in, stretched our legs as well as we could on things and off we went, bumping, rocking, knocking until the base of the head hurt, towards Mongolia. Soon the legs would get stiff and the head keep hitting the crude sticks in the frame of the "cover"—but that was eventually overcome in part by the forming of new habits and instincts.

Were soon over the boundary—a lone Cossack on guard at the boundary post—through the dirty but picturesque Chinese "Maimatzen" (trading town) beyond, and on the grassy boggy plain of central upper Mongolia. From here on almost constantly met Mongolians on small shaggy horses, and I soon learned, to be amply corroborated afterwards, that they were natural horsemen, horsemen by and from birth almost, men and women and the young. Also saw a group of grazing double-humped camels—from some caravan of the Gobi Desert. And all at once I saw in the grass, a bare rod from the road, a white round object—a human skull. Had my first trophy where least expected. Found soon the reason: the Mongols do not bury. They throw the bodies of the dead out on the hills or into gorges near their settlements or camps, to be devoured there by dogs, wolves, vultures and ravens, and what remains of the bones is left to whiten the soil. The bones and even parts with flesh still on are dragged about by the dogs and occasionally brought by them even into such towns as Maimatzen or Urga, without anybody interfering or paying attention. This skull must have



A MONGOL TRAVELING NEAR THE IRO RIVER

HE HAS THE CHARACTERISTIC HORSE, POSTURE IN SADDLE AND OLD-FASHIONED GUN WITH FORK SUPPORT. THE MAN'S PHYSIOGNOMY AND COLOR ARE MUCH LIKE THOSE OF AN AMERICAN INDIAN.

been dragged from some dead body at a distance, for it was alone and without the lower jaw; and no native would touch such a specimen.

Some white low pinnacle-like monu-

ments are seen on a hill to the left—a sort of open-air, crude monument-altars, with which we meet in a number of instances afterwards, near lamaseries.

Near the monuments and scattered

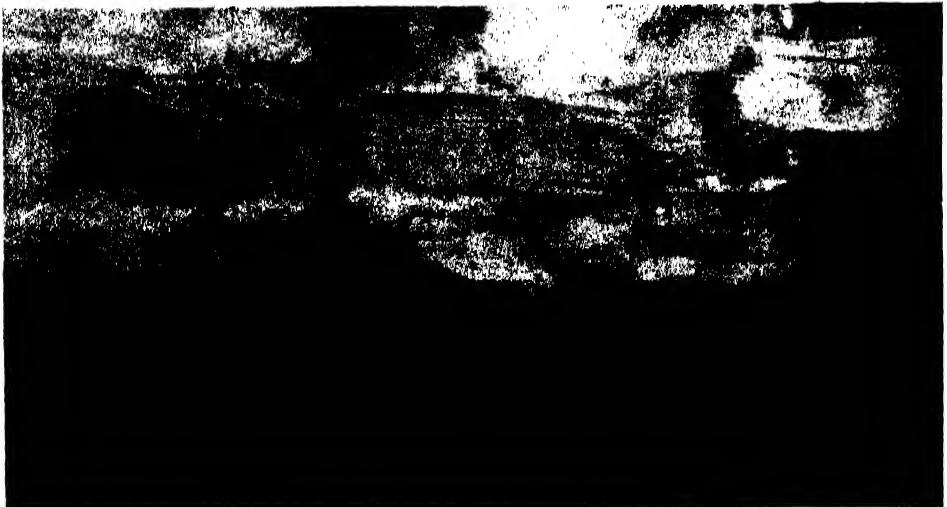

ROCK "MOUNDS" ON TOP OF THE PASS ON THE ROAD TO URGA
TRAVELERS REACHING THIS SPOT PICK UP A PEBBLE, MOISTEN IT WITH SALIVA AND RUB IT OVER THEIR BODY MURMURING THANKS FOR HAVING SAFELY REACHED SO FAR AND PRAYING FOR STRENGTH AND SUCCESS ON THE REST OF THEIR JOURNEY.

farther on the first yurtas—the characteristic transportable dome-shaped houses or huts of the Mongols. They are round, with subconical or rounded roof, made of lattice-work, and covered with thick dark felt fastened to the frame with cords. They are about twelve feet in diameter, nine or ten feet high in the middle, with a door towards the south and a smoke opening (closed by a flap at night) in the top. They are the same, we found later, all over Mongolia, and may be bought ready to put up in the markets. They remind one very closely of the dome-shaped huts of the Apache and other of our Indians. They can readily be undone, packed on a car and moved wherever the owners are bound to. Are warm and would be excellent shelters, were they not crowded with things and humans and especially were they clean; but they are only clean when new and empty, which is once in their life. They must accommodate all the family, and its possessions, and when colder even some of the household animals. Their felt cover when new is near white but with age and smoke gets blackish-grey. Inside are a primitive iron range or firebox and a brazier in the middle, a sort of Chinese-made cabinet and upon it an altar at the wall in the north part facing the door which opens towards the south, a little stool at the foot of this cabinet, a low primitive bedstead along the wall to the right and perhaps also to the left of the altar, horse accoutrements, water pails, a crude kitchen-stand, sheep-skin rugs and other articles, taking the rest of the space along the walls, while a mat or two (occasionally) on the ground complete the equipment. In such a yurta on one occasion there were twelve of us at supper. I also slept in one, though with a smaller family. However, of those things later.

Before long after Maimatzen the road began to rise to a low wooded range, and afterwards it was just up or down mod-

erately high chains of hills and ridges, running for the most part in an east-to-west direction.

At 2:00 stopped for lunch on a small knoll in a larger basin among the hills and here it was so warm that we had to take our tea pot under a pine, where we made a small fire. At this top I learned some of the habits of the "yamshchiks" or drivers in these parts. One of these habits, for which we had to pay dearly late that same day, was to stop three hours, "to rest the horses."

While we were waiting here there came by two Russians in an open farm wagon half filled with a variety of mushrooms. Great many of these grow in the woods here, and they are much favored by the Russians. They gather them in astonishing quantities, eat many fresh, boiled or fried or scrambled with eggs, and salt the rest of the caps in casks or barrels, in which they may now be seen for sale in all the markets. A traveling Russian here, we saw later, carried a small cask of the salted caps with him to supplement his meager other provisions. A curious thing—all the Slavs and many other Europeans like wild mushrooms—perhaps a faraway taste acquired while their ancestors were surrounded with forests. The pine woods here looked much like those about Washington—things repeat themselves amazingly in many parts of the earth. . . .

At 5:00 started again and had about twenty-five miles before us to a Russian farm on the Iro River, to the owners of which I had a letter of introduction. The road led over hills and long inclines, and we were going at quite a good gait, but the day also was going, and clouds began to appear above the range before us. Also we were beginning to be bothered much by flies and mosquitoes. Towards 8:00 it got dark, the clouds increased and there was distant lightning. We were crossing another low ridge, the clouds and lightning with deep rum-

blings were coming nearer. The sky above too now was overcast, and before long occasional lightning extended all over the sky and a slight rain was beginning. It was now pitch dark, and we were passing down along an ugly gorge to the right, disquieting glimpses of which we got now and then through the lightning. At one spot a big flash and stroke frightened the horses and they jumped wildly and started to run, but fortunately not off the road before the driver controlled them. Then came a heavy rain, sheet lightning and thunder. We descended to the grassy flats of the river, where on these flats somewhere before us was Karnakovo, our destination. And then we came to a big pool of water covering the track and vicinity. The mosquitoes soon became a pest here, except when it rained harder. There was absolutely nothing to be seen anywhere except by lightning. The driver thought Karnakovo was still distant, and was afraid to cross the deep pool before us. Another poor track was traced a little way back leading to the left but soon seemed to end among the rocks at the foot of the slope down which we came. There was no sign that the storm might soon cease, and we knew not what marshes or holes were before us. So we had to stop here over night. Fortunately I had my "mišok" and rain coats and rain trousers, and the water did not now fall in torrents. So with everything on, the rain coats over the exposed parts of the bodies and the wagon turned with back against the wind, F. and myself huddled in the wagon, so narrow as to accommodate two only when extended but so short that one could not extend fully; and with mosquito netting over our heads passed a miserable portion of the night. The driver made himself a little shelter in front of the wagon and slept on his things on the wet ground.

The rain must have stopped late after

midnight; and at about half past three, with the first signs of the dawn, I was awakened by the stamping of horses near the wagon, and by a curious hum above our heads as if of bees. This soon proved to be the song of innumerable mosquitoes that were waiting for their victims. The driver was up, too. We crawled, half cramped, out of the wagon; and then, as soon as we could see clear—there, but half a mile away from us, across the marshes, was Karnakovo! Then the safety valves blew off for a minute. . . .

However, did not dare even then to go over the pool and the soggy ground beyond and so, fighting the viciously hungry mosquitoes and with two eagles screeching over us—probably had their nest somewhere in the nearby cliffs—we took the rocky road, helped the wagon with our hands and shoulders over the stones which otherwise would have wrecked it, and in a roundabout heavy way a little after 6:00 reached Karnakovo.

And here I found a Russian woman of about fifty-five, the farmer's wife, who had had advanced education, had written and published several good papers on the Mongolians, and even spoke fairly good English. We were received as warmly as friends, fed, put in warm beds to rest, dried, fed again and then taken to Mongol yurtas, and after that to a lamasery, where all were friends of Mme. Karnakova, who treated them when sick and had learned their language. We stayed over two days to recuperate, photograph, search and learn much. Here another good skull was added to my collection, and a Mongolian paid me with a "haidak," a fine light blue ceremonial silk kerchief, for having pulled (with my fingers) a bad tooth out of the jaw of his little boy. They offer these haidaks to the gods, they give them to friends, and they show with them their gratitude and friendship to others.

Then we went on again, fighting the



MONGOLS OF THE HIGHER CLASSES

Top: MONGOLS OF THE WEALTHIER CLASS IN GALA DRESS. *Bottom:* "CITY" MONGOL OF URGIA.

mosquito pest all the way; sleeping (if sleep it could be called!) one night in a flea-infested yurta—the next morning had twenty-eight bites on the back of one hand only; another night on the wet

ground under the wagon with drizzle part of the night; and third in still another yurta, it being too cold to stay outside. Crossing some outrageous mountain roads, walking up hills to ease the



TWO TYPICAL MONGOL SISTERS
THE ONE ON THE LEFT IS SLIGHTLY OLDER AND MARRIED; THE ONE ON THE RIGHT IS UNMARRIED.
THEIR EYES HAVE ALREADY LOST THE EPICANTHUS AND ARE QUITE HORIZONTAL.



YOUNG MONGOLIAN WOMAN, RECENTLY MARRIED

horses; and on better stretches of ground dozing in the wagon to make up a little for the nights. As to meals, night breakfast at 4 A.M., lunch 9:30 and dine when stopped for the day; or breakfast at 6 and lunch at 2 or 3—as the horses, not we, required, or as could be managed. And meals all the same—ham, cheese, bread, tea—but we varied the order; only the last day when cheese was out succeeded to get at a Chinese farm a supply of eggs. Of tea from four to five cups at a sitting, but not strong—a teaspoonful and a half for everything

that were tied to it, for we were approaching the region of the "Hunhuzes" or bandits; F. and myself stayed in the hut making our bedding on the dingy floor. Both soon asleep, regardless. But almost in no time, it seemed, I felt as if hundreds of ants were running over body, and every now and then some spot began to burn. As soon as awake enough it dawned on me they must be fleas. Nor was there any illusion about this. They were there in undreamt-of numbers. And F. was in a similar condition. So both jumped up, lit candle and endeavor



ONE OF THE PALACES OF THE CHIEF LAMAS IN URGA, MONGOLIA

for the three of us. And thus on the seventh day we reached Urga. . . .

The night in the flea-hut was almost the limit. It drizzled now and then that day and was cool. Towards evening among low hills found an old woman's skull—learned later she had been killed and eaten by savage starving dogs. Shortly after came to a hut belonging to and sometimes used by a Russian trapper. Just a little shanty, but had a loose plank floor and a damaged stove.

Managed to make tea, and after a humble supper, the driver went to sleep in the wagon so as to be near his horses

ored briskly at least to clean bodies, then dressed and talked things over. Nothing to be done, for they were now in the bedding and no telling with what reserves under the floor. And it drizzled outside, also was cold. So to warm up a little made fire in the derelict stove, and fed it perhaps a bit too much. At all events the pipe was half rotten and before we knew the roof of the hut about the pipe caught fire. And then we hustled, poured on burning part what water there was and beat out the rest with hands, which got blistered; but saved the hut. And then just crouched meanly on



OLD LAMA, CENTRAL OUTER MONGOLIA



YOUNG DISCIPLE
FROM ONE OF THE MONGOLIAN LAMASERIES.

things until it began to dawn. How powerful it felt that morning that man was made for the day and the sun!

At the Iro, a good-sized and deep river, we had to be taken over on a primitive Mongol ferry. Beyond met a solitary Mongol horseman with his quaint long gun, with which goes here invariably a bamboo or wooden forked pedestal on which the piece is laid for aiming. Except for the gun the fellow looked exactly like an American Indian—and again and again one sees here features that are just Indian.

A Mongol caravan is a sight worth seeing, though not hearing. It consists of anywhere to forty or fifty two-wheeled carts of a type that must have been common three thousand years ago. The body of the cart is of the simplest—just a crude flat platform with a simple rough railing on each side, and a cross piece in front on which sits the Mongol—if he is riding on the cart—which however is seldom the case—for due to self-evident reasons he prefers walking or riding his horse. But the “joy forever” are the big wheels. They are made of single cross-sections of a tree, revolve on a stout home-made wooden axle on which rests the car, and are worn off each in a different way and to a different degree, with the result that as the car goes it wobbles irregularly and makes all sorts of outlandish noises. A string of such cars, with the dust they raise and with their combined grating, squeaking and other discordant sounds, is quite a thing to pass on the road. Have however seen and heard identical sight and sounds in parts of Mexico. . . .

As to the Mongol himself—the fierce ruthless warriors of Genghis Khan or Tamerlane are to-day the meekest and friendliest of people. If you see a Mongol on the road he begins to broadly smile at you from as far as you can well discern him, and he keeps on smiling, if you look at him, until you lose sight of



TYPES OF MONGOLIAN MEN

Top: YOUNG MONGOL SHEPHERDS. THE MONGOLS DID NOT FARM; THE REASON WAS THAT THEIR RELIGION FORBODE THEM TO HURT "MOTHER EARTH" THROUGH DIGGING. A GREAT NUMBER OF THEM WERE SHEPHERDS, MANY TENDING LARGE HERDS OF HORSES. *Bottom:* MONGOL GIANT OVER SEVEN FEET TALL FROM THE URGU REGION; ACROMEGALIC. GOOD-NATURED BUT NOT VERY INTELLIGENT.

him. One wonders if history, which paints them so fierce, can be correct. But they are still the inveterate old nomads. One passes a whole village of their yurtas to-day—and in a few days, returning, finds nothing but a barren ground that just shows where the camp stood. The whole aggregation one day had been loaded on the carts and moved away to better conditions. There are no permanent family habitations, and the Mongol does not till the soil—it would, according to his lamaism, “hurt mother earth to plow it or dig into it.” So whatever agriculture there is is in the hands of the Chinese and a few Russians, as are trade and manufactures. The Mongol is the lord of the wastes, with his horses, sheep and cattle. He is not even much of a hunter, for that too is against his religion. Yet he is not free—is under the yoke of the lamas on one side and his own “rich” on the other. . . .

At last reach Urga, the “capital” of Mongolia, and a strange sight meets us. Also, in the outskirts, rather foul air in places—learn it is the smell of what remains of the bodies that are brought out, whenever there is death, for “burial by animals.”

Urga lies in a large shallow alluvial depression, above the Tola River. It is a conglomerate of Mongol monasteries, Mongol yurtas, a few Russian houses and a quarter of Chinese dwellings. It is separated into four parts, which are from west to east, the principal monastery; “Kirin” or native town, with another monastery; the Chinese quarter; and the scattering of Russian houses. In addition to which there are two large long market squares; two outside enclosures with gaudy palaces of the chief Mongol religious authorities; the Russian consulate, hospital and barracks; the old Chinese trading town or “Maimatzen.” And in the native parts hundreds of mangy dogs and curs on the excessively dirty streets, and refuse

heaps. The heterogeneous compound extends for about four miles in length from east to west and for about a mile and a half in maximum breadth, at some distance from the river. The stream itself skirts a long wooded “holy mountain” just to the south of it—an open-air menagerie and a general reservation. The town has usually about sixteen thousand inhabitants, and is surrounded by hills, the nearer slopes of which I became quite acquainted with before long in search for skeletal remains.

The long mountain-ridge beyond the river is sacred; no one must cut any wood there or kill any animals. It is a real natural law-protected zoo, of the chief lama ruler, and is said to be stocked with bear, deer and other creatures.

We stopped in the Kirin section, found soon a nice room in a Russian house, and there before long I had fixed my photographic apparatus and, under the floor, a dark room. My plates, for a wonder, with all the knockings they got over the rough roads, came unbroken. I engaged as help a few of the natives and the subjects were brought to me. The Mongols here too were found generally good-natured and they knew of photography, yet it was quite difficult to get some of the best types and often impossible; nevertheless, in the course of the twelve days of my stay I was able to use up all my plates and films, and make many observations.

But all the time while in Urga I had to fight a cold brought from the trip and it was necessary to sleep on the floor with the chill from the moist low earth cellar underneath penetrating through the boards, and to breathe a lot of dust every time one went out of the house, so that the nose and throat and heat got better but slowly. Wanted to write, but it was out of the question. A letter home was commenced four times. When the day work was over there was some time, but had to go out into the hills and gullies



VISITING LAMAS FROM TIBET

to collect skulls until too dark to see, then take them around the town to the distant Russian hospital, come home late, have a bite, and get into the blankets.

Uncertainty of work—now a rush, now tedious waiting; the disturbed head; unwillingness of the driver, who did not fancy the task of going with me to collect



MONGOL WOMEN BEATING WOOL IN PREPARATION FOR ITS UTILIZATION

specimens, many of which still smelled badly, and other difficulties, made a coherent recording of things impossible. . . .

The collection of skeletal material here proved almost as grim as that ten years ago on the Yaqui battlefield in Sonora. There were as near as could be found out about 600 deaths a year at Urga. Of these none were buried except the whites and the Chinamen. With the Mongols a body must not be introduced into the earth, it would offend and pollute. So when there is a dead one they place him, without clothes, in the early morning, on one of their crude flat cars, drive into the foothills, then without daring to look behind lash the horses into a gallop over stones and hollows until they feel the body drop in the place of its "choice"; and then without a glance back ride as hard as possible to where they came from. The car from the start had been followed by dogs, and soon there would be also kites and ravens and perhaps a wolf or more converging to the group, to pounce upon the body the moment it dropped and tear and devour and snarl and fight, until not a vestige is left of the young, and but the skull with a few scattered remnants of the hardest parts of the long bones of the adults. Often the dogs would bring parts of the limbs, and even a head, onto the dirt piles within the town itself, as I saw amply with my own eyes; and the ugly mangy dogs in general would return after their feast to town, to spend the rest of the day lying lazily about. Gruesome—but all "as it should be" according to the teachings of the guileful lamas. What perversions possible under guise of "religion." . . .

Strangely, the heads of the adults, while deprived by the beasts of all flesh, would be left almost as they were, to remain in the gullies and over the slopes until carried away by water or ice. And it was these skulls that I was anxious to

secure, for they would be of prime importance in connection not only with the study of the Mongols but also with that of the mongoloid affinities of the American Indian. There was thus a sufficient aim and cause and the rest needed only care not to be seen by the Mongols, and endurance of the conditions.

Being a medical man helped much with the work. But a good many of the specimens found were more or less recent. Quite a few still had the brains in. And many such smelled unendurably almost, except perhaps to one used to dissection and autopsies. Even thus, however, it was necessary time and again to remind oneself of the indispensable need of the collection.

The first night tried with our driver, who followed me with his cart—but this almost ended catastrophically, for he got sick from the sights and heavy smell, and was frantic even the next day when he found that no amount of washing would quite do away with the remains of the odor in the wagon. No money I could offer would induce him to go again.

Meanwhile I had made friends with the principal Russians, including the military and their hospital, and the latter came to my aid. The hospital, isolated in the outskirts of the town and near the small Military Post, had a deep yard and at its end in one of the corners a shed. Seeing my dilemma they gave me two mixblood Cossacks and a servant, and loaned me a big iron pot. We then dug near the far end of the yard a big hole in the ground, made fire there, suspended the pot over, and here day and night henceforth one or two of the men would attend to the boiling of the specimens—while one or two would go with me every evening over the grounds and carry the skulls I gathered in a bag. Towards the last, when finds were getting scarce, there was so much ground to cover and the men knew so well what to do, they would go alone, besides my-



TYPES OF MEN FROM CENTER OUTER MONGOLIA

Top: BEARDS OF THE SORT WHICH THIS MONGOL WEARS ARE NOT RARE AMONG THE OLD MEN OF THIS REGION. NOTE THE DEFORMED RIGHT EAR (CONGENITAL MALFORMATION). *Bottom:* MEN TYPICAL OF THE CENTRAL PART OF OUTER MONGOLIA.



TWO TYPICAL MARRIED MONGOLIAN WOMEN
ABOUT THIRTY YEARS OF AGE AND IN THEIR "SUNDAY" DRESSES.

self, and collect. How they bore to carry the sacks on their backs was a wonder. I could not even walk very near to them. And there was the constant apprehension—did not know how the lamas would take it. But there were the understanding good Russians. . . . Luckily the grounds were not very close to the outermost yurtas, the dogs were too lazy and dull to mind anything that was out of their schedule, and the Mongols were doubtless very shy of the places we roamed over; so that all ended satisfactorily.

The boiling and cleaning, in which even the hospital felchar (male nurse acting as doctor where real doctor could not be had) occasionally assisted, proceeded ceaselessly until the whole precious material was in good condition. There were 213 skulls, with but very few of any account left about Urga. They were ranged on planks in the shed—but they still smelled. So a good amount of permanganate of potash was

obtained and they were steeped in a strong solution—yet on drying they continued smelling. Then I had a Chinaman make me a lot of small boxes and packed the specimens in charcoal, which could be had here; some months afterwards the boxes were opened in the National Museum at Washington—and the skulls still smelled. It was the brains. . . .

Can never thank enough the Russians. No people could have been more genuinely helpful, and that not only at Urga. After I showed them my Imperial Geographic Society paper not one, even on the guarded boundary, ever asked me for another document. The official permissions, which eventually reached me after such a bother in St. Petersburg, were never taken out of their envelopes. At Urga the Russians not only helped me with the work on the living, with seeing what was worthwhile in and about the town, and with the very great favor at the hospital, but when all was done and



INDIAN-LIKE MONGOL WOMAN AND HER FAMILY

THEY ARE STANDING IN FRONT OF A *yurta* IN WHICH THE AUTHOR SPENT A NIGHT.

packed they sent out all the collections and plates, in one-pood (36 lb.) boxes, without a cent's expense, though first-class mails, to St. Petersburg. I wanted to help all I could in the sending, and at the same time feel sure that nothing happened to the hard-earned collections before they got out of Mongolia; so engaged two additional Russian wagons, took everything along, and after five days delivered everything safe to the postal authorities at Kiakhta.

This is a very rough and imperfect sketch of the doings in Mongolia. What shall I say more—how I saw one whole afternoon a great open-air barbaric Mongol religious ceremony at one of the monasteries, with about six thousand Mongols in attendance; where with grotesque masks and strange costumes they revived Kublai Khan and others of their history; where in one "scene" the trumpets of the lamas were thigh bones of virgins; where transfixed lamas in

heavy accoutrements danced or combated until falling from exhaustion. Or how the Mongols—the best horsemen and horsewomen probably in the world—raced home, horses with wild riders falling here and there and always rising and galloping again, while our "horned-toad" galloped madly with us in his "tarantas" over holes and gullies? How cold drizzling rain tortured on our return? How on coming to Kiakhta, with more money spent than calculated and barely enough left for local expenses, I was told at the only little bank there that they could change no money and how Colonel Chytrovo and later, at Verehni Udinsk and Irkutsk, other high-minded Russians, helped me along until I had what was needed? Yet there are a few little incidents that may deserve a special mention.

One day went to the sacred mountain. Crossed the fair-sized river over a bridge and walked a distance over the wooded and grassy lower slopes. No one at all

anywhere. Some tarbagans (marmots) scampering to their hollows. Soon after a deer—stands at a distance and just looks. Dare not alone go deep for the bears. A strange caprice of the chief lamas this “sacred” zoo and mountain. But they are not savages. Like the monks in the dark ages they carry on a certain degree of culture. They read and write five dialects, and there is published by them even a sort of periodical of which I saw a number. . . .

At Urga, of an evening, late in my room, after a hard day’s work. Suddenly hear a song—and in a moment feel as if transposed to some of our Indians. Can not make out the words, but the tune and all about the song is so thoroughly Indian that for a while am uncertain as to where I am. It was a young Mongol and he has now disappeared behind some yurtas, yet I still hear that Indian refrain. . . .

Visiting in a Russian house. Have much to do every night to get rid of the smell of the skulls so no one objects, but have things to work with and so change. A stranger arrives from eastern Mongolia. Is a Swede of about 40 and has been selling Bibles, printed in Mongol, to the natives. There are, I learn, some Missions. The man looks rugged and not very opulent. But of all the occupations a strong man selling Bibles to the Mongolians strikes as about the queerest. . . .

A pass over a range of mountains. A large high pile of small stones at most elevated spot—strangely familiar—have seen the same thing in the Hopi region, except that here there are a few light poles projecting at different angles from the pile and from their points flutter now ragged and discolored haidaki—silk-cloth offerings. And on inquiry find the pile has the same meaning as with our Indians. Each Mongol reaching the pass, after the laborious and rather dan-

gerous (for there are bears and even a few tigers here) journey up the mountain, picks up a pebble, moistens it with saliva, rubs with it his tired muscles, raises the pebble up with brief thanks and a prayer, and deposits it on the pile. Same “tired stone heaps” may be met with in the Andes and other mountains of America. . . .

The Chinese at Urga are making a giant copper Budha for the local monasteries. It is to be about 90 feet high. The whole work is carried on, largely in the open, in primitive ways and very slowly, yet effectively. The ingenious Chinese workers can not but be admired; and quite a few of their tools are very much like those I used to see in my childhood in central Europe—wonder which were the original. . . .

The Mongol lamas make, and sell cheap, remarkable intricate religious paintings in which a fine deep cobalt blue is most conspicuous. Some of these products are real pieces of art. Regret I did not get a whole collection. . . .

On the main “square” in Urga. At an old wall, seated on a sort of low platform, a female bard, of perhaps 50, interesting face, a quaint sort of a guitar. Sings and accompanies herself on the instrument. Sings very different from that man that night—almost as in the Balkans. A small crowd of Mongols about her and copper coins are given to the singer. Listen to her and watch her with much pleasure and gladly give also, for she is genuine, at times even elated with her own ballad. . . .

Go to see a Chinese house. Astonishing carved decorations even on the outside, though this, for protection, is just a wall with a carved and gaudily painted central gate. Inside find a spacious slab-paved square patio with verandas about it, and on these flowers and cages with birds—as in the better homes of Spain or Latin America.



A BEGGING LAMA CARRYING RELIGIOUS PICTURES RELATING TO LAMAISTIC FAITH

THESE LAMAS USED TO ROAM OVER THE COUNTRYSIDE, LIVING ON THE PEOPLE AND EXACTING AS MUCH TOLL FROM THEM AS THEY COULD POSSIBLY SECURE.

Enter, with F., on a side of the yard, met by a well-groomed prosperous looking young Chinese merchant, in a silk blouse and round dome-shaped silk cap. Invites us smilingly and pleasingly politely to the next room, where we sit on rug-covered little bench-stools, while our host excuses himself only to return in a little while with a male servant bringing hot tea, of which the host partakes with us in all cordiality. Is a merchant, as all the Chinese here, but we only see his "store" after we tell him—he understands a little Russian—that I should

like to buy a pound or so of the fine "mandarin" tea of which I have heard. The store is in another part of the house, unnoticeable from outside and without any display of goods. We get what was wanted, pay a fair price, are friendly and not in the least obtrusively conducted out, and part regretting there is not another purchase to make. . . .

Another Chinese house. I was asked to bring home some of the fine white "astrakhan" fur, if obtainable. Find that there is plenty of it here, so desire to buy a skin or two. Go with F. to



WOMAN BARD ON THE MAIN SQUARE IN URGU, MONGOLIA

the largest establishment. Are met by a well-dressed middle-aged Chinaman, who very kindly shows us a great heap of tarbagan furs and another, smaller, of the beautifully curly pelts of the white lambs. That, I tell him, is just what I am after. But he replies with a smile, to my astonishment, that he can not sell any to me. But why—why not sell to me? Want but two or three, though the best ones. No—can not sell. And thus for a while, until he takes one of the furs, passes his palm over it—and shows us on this some hair that has come out. Repeats it with another fur—and then I understand, the skins are not good enough for me, have not been tanned properly, some of their hair will come out when worn. O Diogenes with your lamp, here at last is your honest human! . . .

Going on from the Iro. Sitting in the back of the wagon and killing mosquitoes. There are several varieties and the quantities are inexhaustible here near the river. One species, color of dried leaves and speckled, is especially large and easy to get. Just offer the forearm and the legs and keep on slapping, and when one hand gets tired use the other. Before we reach the higher and freer ground have quite a harvest, and there is some satisfaction. . . .

Near the road a few huts of Russian trappers. Stop with them over night. Several are home, and tell me of many fossil bones, some of huge size, in gorges, in the region, in which they hunt and offer to accompany me to them; but the trip would take a day to go and a day to come back, which I can not spare at this juncture, and there is another reason. This is the country of the Hunhuz. They are said to be mostly former provincial soldiers who had not been paid, and so deserted and try to get whatever was coming to them by banditry. They do not kill unless opposed, but take horses, provisions and valuables. Dur-

ing the night our horses are watched constantly, but nothing happens. . . .

Aug. 26. Once more on the Selenga. 5:15 P.M. The boat leaving the barren shore—good-bye Ust-Kiakhta and what lies beyond. Good-bye for the last time, for I do not expect to return.

Again on the clumsy "Rabotnik," on the swollen river, among the poor hills, but this time sliding speedily down with the current towards the great artery of all these lands, the Trans-Siberian.

The gate to the strange world from which I just emerged is rapidly closing behind, and the last chapter of this year's Odyssey commences, the one of a slow coming home. With two lightened satchels, a blanket, a little bit of a pillow, a holey umbrella and a weather-worn raincoat; with the stomach filled with a liter of good milk, half churned over the last piece of road, and greeting the first swallow since this morning; with the body and eyelids still some weary but nearing the normal; with the brain filled with late gleanings and recollections and contented over the material results of the voyage; and with the heart warm and yearning—so I begin my journey back towards the States, over Europe; it became impracticable to go the other way, over the Pacific. Feel happy again—not exuberantly, or lightly as the lark, but soberly and preciously; like the ship that has recently been much tossed about and now sails slowly into the harbor of its final destination. . . .

Verchni Udinsk. A pioneer city—much like some of our own western towns. Large plate-glass windows to some of the stores, the first seen in Siberia—am told they came by Vladivostok from America. And to complete the picture for the first time see men from the country carrying openly cartridge belts and big pistols. Some shooting in fact during the night. . . .

Arrive at Irkutsk. Have since a week been vexed by lack of Russian money,



MARRIED MONGOL WOMAN
SOME SUCH FINELY DRESSED WOMEN ARE CALLED
"PRINCESSES" BY THE MONGOLIANS.



MONGOL WOMAN IN HER FINERY
MUCH OF THE DECORATION IS EXQUISITE SILVER
FILIGREE, PROBABLY MADE BY THE CHINESE.

and the French banknotes that were supposed to see me throughout Russia, could not be changed either at Urga or Kiakhta. Had to borrow from Colonel Chytrovo enough to take me to Irkutsk, where there are banks that will surely change me what I need. So get off the train here and walk to the good-sized town over a long low wooden bridge. Everything appears strangely inactive. Reach the main street, which is like in some smaller European town—but here too everything is uncommonly quiet, though it is near ten in the morning. Catch up with a lonely pedestrian, ask him where the nearest bank is—and he informs me this is a "prazdnik" (holiday) and none of the banks will open; not until to-morrow. Ask him where I could change a French note and he can not tell me. A nice how-do-you-do. Have not enough Russian money to even pay for meals. Passing wistfully a large house see in a window sign "Sibir"—a local newspaper, and inside a bearded man working. Decided to turn to him. Go in, find the office, am received civilly and learn the man is F. T. Shiriaiov, editor of the *Journal*. Show him my "open letter" from the Imperial Geographic Society, and tell of my difficulty. He is interested, friendly and asks me to wait a little till he finishes something. Then goes out with me and brings me to a good friend of his, a hotel keeper, and he good-naturedly changes me a hundred franc note without objection, promising more later. We then have a light lunch and my new friend, who is also the secretary of the local branch of the Imperial Geographic Society, takes me to the museum of the society. Find admirable collections, and then am led to the rich library, where on a shelf my friend shows me elatedly a line of the green-bound torch-marked publications of the Smithsonian Institution, including a couple of my own contributions. . . .

Late that afternoon am guest at the house of my new acquaintance. He has a still young pleasant good-looking wife, a fine daughter of 16 and a slightly

younger son. All accept me as they would an old friend. All are musical, and after the enjoyable meal they play and sing, in Russian, wonderfully and wholeheartedly. Must tear myself away with force late in the evening to get to train. Find that my friend was a political exile to Siberia. His punishment was a banishment for a number of years to the Irkutsk district. It seems to me in some such cases the exile would rather have turned out a reward than punishment. But his was a "light" case. Anyway he married locally, established here his permanent home, became the editor of one of the foremost Siberian papers, and is evidently generally esteemed.

September 6. Leaving Siberia—and something almost hurts. Russian America. Thanks to you once more, Mue. Karnakova, Colonel Chytrovo, friend Shiriaiov, and all you Russians, Cossacks and even Chinese at Urga.

Am alone again since some time. F. is returning on the "poctovoi," the mail train, which is much less expensive—though even I am not on the best one. The summer is nearly over, autumn tints prevail, and nights are cold. Many little episodes on the road again. A train crowded to limits with baggage of all sorts and birds in cages, melons on floor, samovars, women, children. A party of overbearing loud Germans at a station—the Russians, shamed, turn away from them. At smaller stops see again and again women with a little child holding the skirts, a younger one on the arm, and another expected. . . . As we cross the Urals, this time more to the south, see many workings in gravel for platinum and precious stones. . . . At a large town beyond they sell articles in jet-black iron, some of which genuine little works of art. . . . Crossing "matushka" Volga over a long bridge—sandy shores, semiarid wastes both sides.

. . . Gorgeous treasures at Moscow in the Kremlin palaces. . . . And so on, to the Berezina of Napoleon's disaster, over White Russia to Warsaw, and then across the rest of Europe to England and thence to America. . . .

A few last thoughts to Siberia. A vast country, vast forests, probably great other resources—but near all yet for the future, when there are enough of men, and when men have harnessed and softened nature. But already it is a new,



A BARD AND HIS INSTRUMENT
MEN AND WOMEN BARDS ROAM OVER THE COUNTRY
MUCH AS THEY STILL DO IN THE BALKANS.

much freer and stronger Russia, untrammelled largely by the past, forging onward. Country of the hunter, trapper, miner, pioneer in all lines, as used to be and to some extent still is our West. Some day—not soon, yet probably not too far away—it will be the revitalizer of the old Russia; and from it will rise strong men and women, mentally as well as physically. Will be a new human light, and power, a century hence. . . .

SWORDFISHING WITH THE HARPOON IN NEW ENGLAND WATERS. I

By Dr. E. W. GUDGER

HONORARY ASSOCIATE IN ICHTHYOLOGY, AMERICAN MUSEUM OF NATURAL HISTORY

On a day in July, 1922, I disembarked in New Bedford, Massachusetts, from a steamer from Woods Hole, with a swordfish sword in one hand and a suitcase in the other. After visiting the interesting whaling museum, the pangs of hunger drove me to a restaurant for luncheon. On the bill of fare I read "Swordfish Steak." I had never eaten one, but I decided to remedy that deficiency at once. So presently, with a swordfish sword across my knees, I ate a delicious swordfish steak, in what had at one time been the world's chief swordfishing port. And then and there was begot a desire and determination to study this splendid fish and the methods of taking it.

But alas, many other fishes and many

other things occupied my time for years and years. But in the fall of 1936 the Michael Lerner-American Museum Cape Breton Swordfish Expedition returned to the museum with a wealth of swordfish material, not the least interesting being a beautiful skeleton and a barrel of swords. And presently there was prepared the much-admired swordfish exhibit of which the central object is the splendid model of Mr. Lerner's great 601-pounder taken with rod and reel.

In July, 1937, there was sent to me a snapshot photograph showing a swordfish's sword at the very moment it penetrated the side of a fisherman's dory. And a few weeks later there came in a board from the bottom of a dory rammed

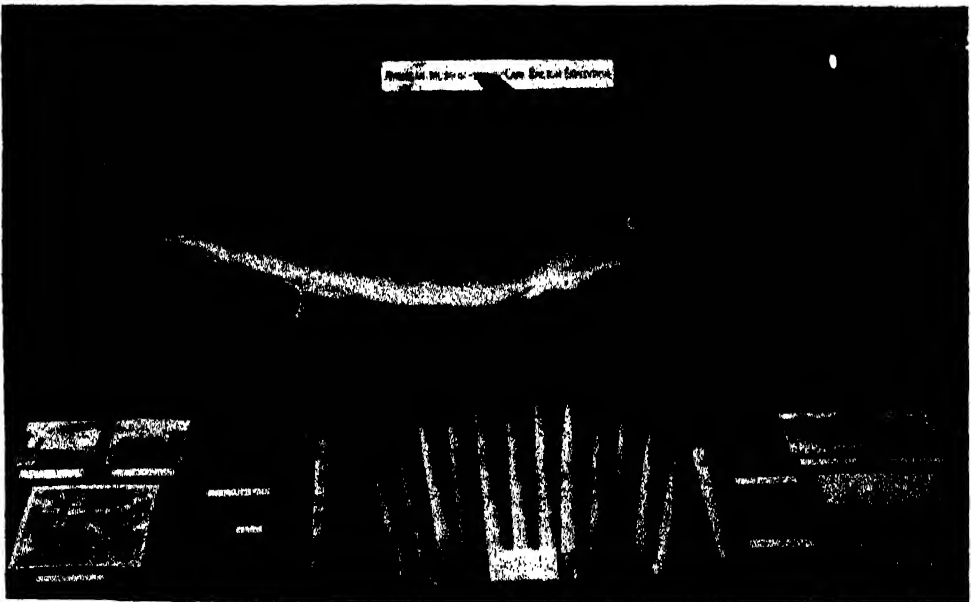

DISPLAY IN THE AMERICAN MUSEUM OF NATURAL HISTORY
TROPHIES BROUGHT BACK BY THE AMERICAN MUSEUM-MICHAEL LERNER-CAPE BRETON EXPEDITION
IN 1936. THE SWORDFISH IS A MODEL OF THE 601-POUNDER CAUGHT BY MR. LERNER.

by a swordfish off Montauk, Long Island, with the sword still embedded in it.

With these incentives, I went to work studying this most interesting fish, its habits and the methods by which it is taken. Some of the things which I have learned, I have passed on in a short article which may be called a preliminary report¹ on what are apparently retaliatory attacks by the fish on the fisherman's boats. In another and larger paper, I have treated fully the fishing for *Xiphias* in the Strait of Messina,² a region in which the swordfish has been sought from prehistoric times to the present day.

In addition to these studies in the history of swordfishing with its perils and romance, I have made an extensive study of the pugnacity of *Xiphias* and the

spearfishes and have found in the bony structures of skull and spinal column the explanation of how and why they can bury their swords deep in the hull of a wooden vessel without "breaking the neck" or dislocating the spinal column.³

And now I am ready to bring the reader to those waters in which the swordfish has been sought for only about three quarters of a century, but in which time the fishery has been raised to an increasingly high degree of efficiency and success. For this general region, and particularly for the offshore waters of New England, there is a great accumulation of interesting data covering 75 years' fishing. But before plunging into the story it will be interesting to set forth the earliest evidences of the occurrence of the swordfish in the Western Atlantic.

¹ *Natural History*, 1938, 41, pp. 128-137, 12 figs.

² *SCIENTIFIC MONTHLY*, 55: 36-46, 8 figs. 1940.

³ *Memoirs Royal Asiatic Society of Bengal*, 12: 215-315, 9 pls., 22 text-figures. 1940.



Mazzullo, 1906

HARPOONING PESCE SPADA IN STRAIT OF MESSINA

THE LOOKOUT ON THE SHORT MAST HAS LOCATED THE FISH, THE OARSMEN HAVE PUT THE BOAT ONTO THE PREY, AND THE HARPOONER DRIVES HOME THE TRIDENT.



Yachting Publishing Corporation
SWORDFISH AT SURFACE

ON THIS FUNDAMENTAL HABIT OF "FINNING" OR BASKING AT THE SURFACE, THE DETECTION AND HARPOONING OF XIPHIAS HAS BEEN BASED SINCE POLYBIUS'S DAY, ABOUT 100 B.C.

EARLIEST RECORDS OF THE SWORDFISH IN THE WATERS OF THE NEW WORLD

On Columbus's first voyage, one of his men on one of the West Indian islands killed a native warrior armed with a swordfish sword—a modern form of which may be seen in the first picture. This sword was taken to Europe and, along with other mementos of his voyage, was deposited by Columbus in the old collegiate church of Siena in northern

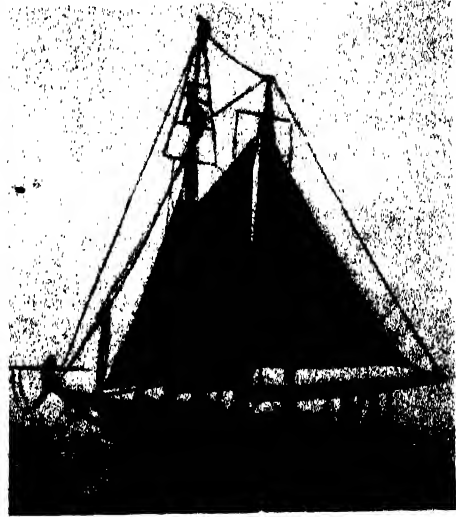

Gloucester Chamber of Commerce
SWORDFISHING SCHOONER

OF ABOUT 1919, WITH A MOTOR AS WELL AS SAILS. NOTE THE THREE MEN ON THE FORE-TOPMAST AND THE STRIKER IN THE PULPIT, THE STEERSMEN AND THE HELPER AT THE WHEEL.

Italy, where he was educated. In this church, closed for long years and rarely visited by tourists, this sword was seen in 1879 by Colonel N. D. Wilkins of Detroit, Michigan, as reported by G. B. Goode in 1883 in his book on the swordfish.

The other account is the first published record (1675) of the occurrence of the swordfish and of its assault on a vessel in the Western Atlantic. This is interesting in itself and because it is the



Charles H. Coles

A MODERN BRONZE HARPOON HEAD OR "LILY IRON"
 THE DOTTED OUTLINE SHOWS THE RECEPTACLE FOR THE POINT OF THE IRON SHANK. THE LINE IS FASTENED THROUGH THE HOLE. THE WINGS SECURE THE HARPOON IN THE FLESH, AND SOMETIMES THE HEAD GOES THROUGH THE FISH'S BODY AND ACTS AS A "TOGGLE."



H. O. Raven

A SWORDFISHING BOAT
WITH AN ENGINE, A "PULPIT," AND A MAST.
THE LOOKOUT STEERS WITH LINES RUNNING UP
THE MAST; THE ENGINEER HARPOONS.



Yachting Publishing Corporation

A LEAPING SWORDFISH
XIPHIAS LEAPS TO FREE HIMSELF FROM SHARK-
SUCKERS OR IN SHEER EXUBERANCE.



Harper's Weekly, 1879

EARLY HARPOON-FISHING
THE EARLIEST PUBLISHED FIGURE (1879) OF HAR-
POON-FISHING FOR XIPHIAS IN UNITED STATES
WATERS. HERE THE QUIZZED HARPOONER STANDS
IN THE PULPIT READY TO DRIVE HOME HIS SHORT-
SHAFTED SIMPLE DART.

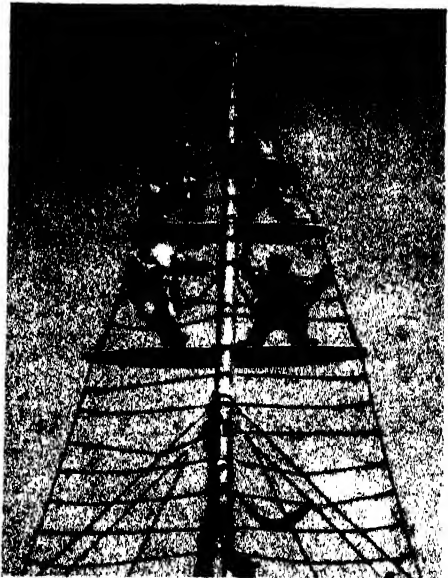

R. I. Nesmith

SCHOONER FORE-TOPMAST
THE FORE-TOPMAST OF A PRESENT-DAY SWORDFISHING
SCHOONER HAS FIVE LOOKOUTS TO SCAN
THE WIDE SEA. EACH HAS A DEEP-VISORED CAP
TO PROTECT HIS EYES FROM THE SUN, AND IS
ANCHORED TO THE RIGGING BY A WINDOW-CLEANER'S
BELT WHICH LEAVES HIS HANDS FREE—ESPE-
CIALLY WHEN THE VESSEL ROLLS.

fourth of the earliest accounts of attacks on vessels by the swordfish.

John Josselyn and a number of associates left Gravesend, England, on April 26, 1638, for what is now New England. On June 20, while "upon the bank of New-found-land," they had an interesting adventure, which Josselyn narrates as follows: ". . . in the afternoon [of June 20, 1638] we saw a great fish called the *vehuella* or Sword fish, having a long, strong and sharp fin like a sword-blade on the top of its head, with which he pierced our Ship, and broke it off with striving to get loose. One of our Sailors dived and brought it aboard."

SWORDFISHING GROUNDS OF THE WESTERN NORTH ATLANTIC

Let us now get a bird's-eye view of the swordfishing grounds of the Western



Gloucester Chamber of Commerce
STRIKER IN ACTION
 FROM A PRESENT-DAY PULEWIT, SECURED TO TWO
 TIMBERS LASHED TO THE DOWNSPIT. EVERYTHING
 IS REMOVABLE AT END OF HARPOONING SEASON.

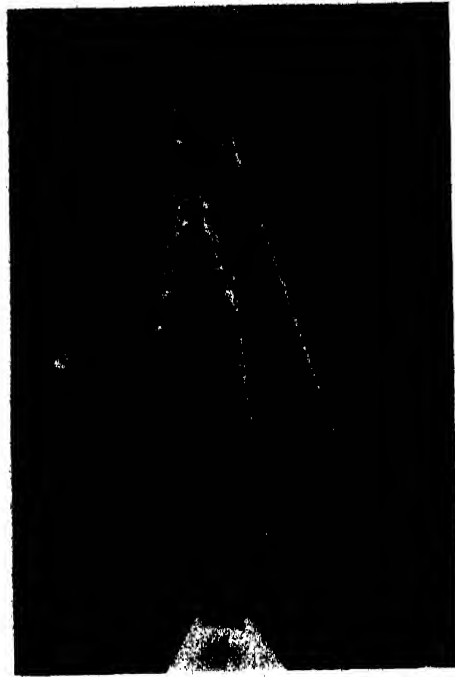

Gloucester Chamber of Commerce
SWORDFISH MAKES OFF
 THE STRIKER RETRIEVES THE POLE OF HIS HAR-
 POON FROM THE STRICKEN FISH BY THE ATTACHED
 WARP, AND THE DISILLUSSIONED FISH TRIES TO
 ESCAPE BUT IS TETHERED TO THE BOAT BY THE
 LONG HARPOON LINE.

North Atlantic. These (p. 424) include the comparatively shallow coastal waters and banks from northern Long Island to Newfoundland, but especially the following banks off the New England coast: Georges, Browns and Le Have. In these shallow waters, shoals of mackerel, menhaden, herring, etc., abound, and here the swordfish are found feeding on these fishes.

In the past seventy-five years, swordfishing in New England and Nova Scotian waters has become an occupation of considerable commercial importance. For instance, in the "high year," 1929, 6,069,000 pounds of swordfish were brought in to New England ports alone and sold for \$908,500. Unfortunately the number of fish taken is not stated,

but if three hundred pounds is agreed on as the average weight of a dressed swordfish, then about 20,250 fish were brought in this season. In the course of these seventy-five years' fishing, many vessels and dories have been rammed by Xiphias, and occasionally a fisherman has been hurt.

Since I have little data for Nova Scotian fishing, this will be considered first and then attention will be directed to the far better developed New England fishing.

HARPOONING XIPHIAS OFF NOVA SCOTIA

How long swordfishing has been carried on in Nova Scotian waters, I can not say. The methods employed are essentially like those used by New England fishermen, but they do not seem to have been developed to the same high point. I have not found any accounts whatever of retaliatory (?) attacks on the boats of the fishermen in these waters, though they probably still occur. Many accounts of such attacks in New England waters will be given later.

I do not have the numbers and weights of swordfish brought into Nova Scotian ports for any year nor for a term of years. But for the port of Louisburg in 1937, the year of the first Michael Lerner-American Museum Swordfish Expedition to Cape Breton, Nichols and La Monte say that it is a swordfishing town of importance and that while they were there—July 28 to August 25, 1937—a good day's catch amounted to over three hundred fish. At an average weight of three hundred pounds per fish, this would mean over 90,000 pounds landed in this one port alone in one day. Probably the total for all the fishing ports in Nova Scotia would be many times that for Louisburg for a season. However, it needs to be said that 1937 was an unusually favorable year.

The boats used for swordfishing out of

Louisburg are small gasoline launches, twenty-five or thirty feet long, powered with automobile engines adapted to the purpose. The launch has in the center a mast about sixteen feet high for the lookout. This reminds one strongly of the masts in the Italian boats used in swordfishing. In the article on fishing for Xiphias in the Strait of Messina, it is shown that rowers, not gasoline engines, furnish the motive powers. With these Italian boats, however, the fishing is done close inshore—in the Strait of Messina. The pulpit, or rest, of the Nova Scotia boat is at the end of a ladder-shaped structure (the boats have no bowsprits) bolted to the deck and easily removable when not needed. This rest, at the prow of a plunging small launch in a swell, offers at best an uncertain stand for harpooning Xiphias.

The crew consists of at most three men—engineer, lookout and striker. Very often there are only two men—the lookout, who has lines at the masthead by which he steers the boat, and the engineer-harpooner, who goes forward to the pulpit when a fish is seen. Seeking the fish, these little launches may go as far as twenty-five miles off shore. The swordfish are harpooned, allowed to tire themselves out, then hauled up to the boat and dispatched. The catch for a trip may run from two or three to six or seven fish, but these latter catches are exceptional. This fishing is rather primitive and the catches small compared to what will be found when New England boats and fishing are described.

HARPOONING THE SWORDFISH IN NEW ENGLAND WATERS

In the shallow waters from Long Island to Newfoundland, the swordfish, seeking his herring or mackerel prey, sometimes gets ignominiously entangled in a net. Sometimes he gets caught on trawl-fishermen's deep-set hooks, but predominantly he is taken by the har-

poon method, and to this we will now turn attention.

In New England waters, as off the Calabrian coast, *Xiphias* is harpooned. In both regions the harpoon-technique is based on two habits of the fish—his basking at the surface and his leaping or “breaching.” These two habits of “finning” and leaping are fundamental characteristics of *Xiphias*. And, since they are the characteristics that make his harpooning possible and profitable, they deserve further description.

The “Finning” Swordfish.—On calm, warm, sunny days, *Xiphias* loafs at the surface with the upper part of the dorsal and caudal fins, and sometimes part of his back, out of water. He seems to be sunning himself, as old Polybius recorded the fact more than two thousand years ago. Such “finning” (and more seldom leaping) fish are easily discernible to keen-eyed lookouts on the mastsheads of “sworders” and the vessels are headed for them. My invaluable swordfishing correspondent, Mr. Wm. H. Hand, Jr., naval architect, of New Bedford, Mass., who has personally harpooned over five hundred swordfish in his twenty-five years’ experience, tells

me that the finning fish swim in great irregular circles and that the lookouts try to guide the boats so as to intersect the orbit of a given fish.

Why the Swordfish Leaps.—It is common belief that the swordfish leaps to shake off parasitic crustacea and to free itself of its commensal suckerfishes (the Echineids). Aristotle (384–322 B.C.) was the first to describe its leaping. He wrote that, “So acute is the pain it (the parasite) inflicts that the swordfish will often leap as high out of the water as a dolphin; in fact it sometimes leaps over the bulwarks of a vessel and falls back on the deck.”

The suckerfishes attach themselves to the swordfish and are carried about by their host. When the host slashes about with his sword in a school of small fish, the suckers (commensals) let go, swim about, feed on the fragments and then return to their home. This external adhesion would seem to cause little annoyance, but when the “suckers” penetrate the gill-chamber, their favorite haunt, they must become exceedingly annoying.

Whatever its cause, whether to free the fish of parasites or in sheer exuber-

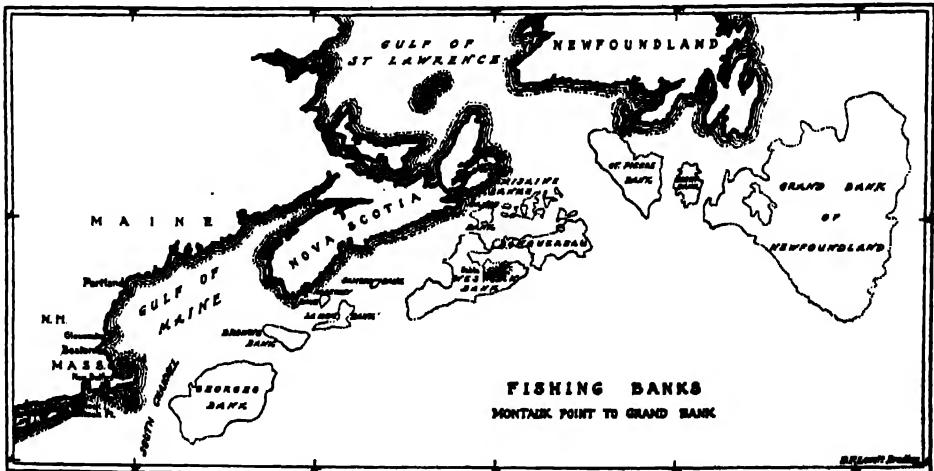

THE FISHING BANKS OF THE NORTHWESTERN ATLANTIC
ON THIS CHART ARE SHOWN THE SWORDFISHING GROUNDS FROM LONG ISLAND ON THE LEFT TO THE
GRAND BANK OF NEWFOUNDLAND ON THE RIGHT.

ance, such a leap may end in a beautiful arc and a quiet disappearance in the water, or in an abrupt fall and a resounding splash. But in either case the leaping fish is visible at a far greater distance than the "finner" and will probably catch the attention of a lynx-eyed lookout on the topmast of a prowling sworder and lead to the undoing of the ocean warrior with the trenchant blade.

HARPOONING FROM ROWBOATS

In Mediterranean waters swordfishing has always been and is to-day carried on from small boats (p. 419). In New England water such boats have been used sparingly, due among other things to the fact that for some reason or other the New England swordfish seems afraid of a small boat, but not of a schooner.

About 1885 some fishing was done out of Saco, Maine, in small boats, apparently about the size of those figured from the Strait of Messina. One schooner is said to have carried a whaleboat rigged out for striking and holding the fish. A swordfish would quickly tire himself hauling such a heavy boat about. This fishing could be carried on only in calm weather and it is subject to three serious handicaps.

First is the small radius of vision of the harpooner in the low bow of the boat. Then there is the difficulty of approaching Xiphias in a small boat, of which all hands agree that that fish in our waters is afraid. And third, there is the difficulty of making a hard and successful stroke of the harpoon from the necessarily low position.

The latest published record (1887) of harpooning from a small boat is from Ipswich, Mass. The fatal termination of this fishing will be recited later. This seems to have been an isolated case and the practice has died out. This is confirmed by Mr. Hand, who writes that "I have heard of fish being harpooned from

dories away back in the old days before swordfishing vessels were equipped with auxiliary power. Fishermen, who have told me about it, indicated that the attempts to catch the fish this way almost always failed."

HARPOONING FROM THE "PULPITS" OF SCHOONERS, 1870-1899

Commercial swordfishing in New England became fairly well established about 1850, and by about 1870 the procedure of harpooning from the bowsprit of a schooner, sloop or smack—all with sails—had become pretty well standardized. In this fishing, advantage was taken not merely of the habits of finning and leaping, which proclaimed the presence of the fish, but of another prime characteristic. This is the fact that, like the dolphin (mammal, not fish), Xiphias seems to find nothing to fear in a bucking, plunging schooner with some freeboard, but unhesitatingly allows it to approach near enough—until the bowsprit is over it—for the harpooner to make his thrust. However, though the swordfish seems almost to play around the vessel's bow, it never allows the forefoot to strike it but always turns aside in time, often like the playful dolphin but sometimes like a surly dog who is not afraid but who nevertheless grudgingly gets out of the way. On this matter Mr. Hand tells me that the larger the vessel, the more closely will the fish allow it to approach. But he has noticed that Xiphias seems definitely to avoid boats and smaller vessels, possibly considering them as enemies.

The earliest account and figure known to me of swordfishing in the western world is found in *Harper's Weekly* for 1879. This short anonymous account, possibly written by G. B. Goode, does not differ from that to follow, but the figure, because of its historical interest, is reproduced herein on p. 421. It

antedates all other figures of swordfishing in our waters. Here the grizzled harpooner in his stand on the end of the bowsprit holds midway of its short shaft not a harpoon but a dart. The figure which appeared but four years later is quite different and authentic (p. 428). The artist must (for the harpoon at least) have drawn not on the facts but on his imagination.

That the reader may understand the *modus operandi* of commercial swordfishing as carried on from a regular swordfishing schooner of fifty tons or less in New England waters from about 1880 to 1899, a figure and descriptions will now be introduced. These are taken from George Brown Goode's splendid brochure, "Materials for a History of the Swordfishes," published in the Eighth Report of the United States Commissioner of Fish and Fisheries in 1883.

Swordfish were harpooned from the bowsprits of schooners, but unfortunately no figure of such an entire vessel is available. The essential persons were the lookout on the masthead, the steersmen at the wheel and the striker in the "pulpit." This man, on the end of the bowsprit, with his harpoon and the line extending back to the keg or buoy, was the vital factor in the fishing. He and his apparatus are all well shown on page 428.

The "pulpit" or rest was a small wooden platform at the end of the bowsprit for the harpooner to stand on, together with an iron hoop or support about waist high for him to lean against. This hoop was welded or riveted to the upper end of a stout iron rod, whose lower extremity was expanded into a ring which was shrunk and possibly bolted onto the very outer end of the bowsprit. Without this rest it would have been practically impossible for the striker to steady himself enough to harpoon the fish in weather other than a calm.

The make-up of the harpoon is shown on p. 428. The handle was in early days a pole of hard wood with the bark left on it to give the striker a good grip. The lower end was pointed and fitted into the socket at the inner end of an iron shank and secured to it by screws or spikes. On the slender outer end of the shank was fitted securely the detachable barbed harpoon head or "swordfish iron." From the harpoon head a line ran along the pole to the hand of the striker on the end of the pole. This line was generally about one hundred fathoms long and at its inner end was attached to a keg or buoy. Not shown was a light line or warp by which the harpooner regained the pole with the attached harpoon shank when it and the shank became detached from the harpoon head embedded in the swordfish. The entire weight of pole, shank and head, was about fifteen or sixteen pounds.

The harpoon head or "swordfish iron" or "lily iron" is not well shown on page 428, and no figure of it alone seems to have been published. To-day the "iron" used is a replica of that of Goode's day. However, it is no longer made of iron but of cast bronze, since this is not affected by salt water. The outer end of the central shaft has two wings, each flaring off at an angle of about 30°. Just below their point of junction is a round hole for the reception of the point of the harpoon shank. At the other extremity are the paired barbs of the harpoon proper. In the middle is the transverse hole for attachment of the harpoon line.

When this dart-head is driven into the fish and the pole withdrawn, the pull on the line makes both sets of barbs catch in the flesh. In fact, as the fish tows line and keg about, the whole dart-head tends to take a position in the flesh at right angles to the pull of the line exerted in the middle of the dart. The whole dart-head then becomes an effec-

tual "toggle," securely holding the fish. This is particularly true when, as sometimes happens, the harpoon head is driven clear through the fish.

Now it is plain that the success of this harpoon-fishing depended on the close cooperation of at least three men—the lookout aloft, the steersman at the wheel and the striker in the pulpit. The boat might have been sailing along over the "sapphire sea" with all the men "taking it easy" save the mastheader, who ceaselessly scanned the sea beneath him. When he saw a basking swordfish in the distance, his cry, "Swordfish!" brought all to active life. By shouts and gestures he directed the steersman how to head for the fish. But when close at hand the harpooner helped to guide the man at the wheel to "put him onto the fish."

This is a fine sea picture: the schooner under a bright sun on a calm sea, the mastheader watching for a finning or leaping swordfish and by his excited gestures and shouts directing the steersman how to follow the fish, and the alert striker in the pulpit eager to harpoon the prey.

The harpoon was not thrown or "pitch-poled" at the swordfish, as it is at a whale, but, with the pole held in the hands, the harpoon head was driven into the fish's back. Xiphias was "punched," in the swordfisher's parlance. The fish then darted off, the pole and shank were withdrawn from the socket in the "iron" and retrieved by the attached warp. The man holding the keg, with the line from the harpoon head to it, allowed the line (about 100 fathoms long) to run out and threw the keg overboard. The haltered fish was next allowed to tire itself out, dragging the long sagging line with its keg hither and yon; "to wear itself out with its own agitations," as one writer quaintly put it. The mastheader kept the keg in sight and presently one or two men were sent out in a small boat to retrieve the keg, to haul

in the line and to bring boat and fish, so close together that the fish could be killed by lance thrusts in its gills and then brought to the schooner.

SWORDFISH HARPOONING, 1900-1940

The method of taking the swordfish is still by the harpoon, but the day of dependence by New England swordfishermen on small schooners, sloops, etc., activated by sails alone, is long over. The fairly large schooners of to-day still have sails, which serve to steady the ship against rolling, to carry her on in case the motor balks, and in a strong gale to help the motor drive her. But gasoline and more lately Diesel engines carry the boats through storms, tide them over emergencies, and on the Banks put them quickly on the fish.

Present-day apparatus is essentially as shown on page 428, even to the keg. The pulpit, however, is generally of heavier construction. A "sworder" of 1915-20 is shown on p. 420. The top of the foremast is given over to the lookouts—here three in number—the striker is in the pulpit, the steersman at the wheel.

I have sought far and wide for a broadside view of a present-day swordfisherman—but in vain. However, I have a splendid picture of a foretopmast with five lookouts, like a group of gigantic birds (page 421). These lookouts are in three tiers, and below is room for two more. These five (sometimes seven) men, with wide-visored caps, are needed because of the intense glare from the water, which calls for more eyes and which would make it hard for one or even two men to watch the whole wide mirror of the sea below them; because the greater speed of the motor-driven boat over the old-timer enables her to cover far more territory; and finally because (as Mr. Hand states) the swordfish tend to swim in wide irregular circles. In directing the steersman (who can not see the quarry) how to turn and dodge



Goode, 1883

HARPOONING IN NEW ENGLAND

THE *modus operandi* OF HARPOONING XIPHIAS OFF NEW ENGLAND SHORES IN THE LATE 1800'S. THE HARPOONER STANDS IN THE PULPIT AT THE END OF THE BOWSPRIT, HOLDING A LONG-HANDLED HARPOON, TO WHICH IS ATTACHED A LONG LINE WITH A KEG OR BUOY AT ITS INNER END.

to enable the boat to cut the arcs of not one but several fish, the lookouts must develop an excellent judgment of angles and distances and speeds. The lookout's job on a modern motor-driven sworder certainly has developed into a fine art. As a result of all these factors, many more swordfish are harpooned than in the old days of slow-sailing schooners with only one or two lookouts.

All this is very fine on a quiet day—the bright sun, the mirror-like sea, the finning and leaping warriors of the deep. But because the men are sixty or seventy

feet above the water, on even a moderately rough day they are subject to tremendous and very unromantic rolling. On the point Mr. Hand writes about, "Ideal swordfishing weather is, of course, the finest weather with the smoothest sea, but the professionals continue to fish frequently when the weather is quite bad, and then the rolling in some cases goes through an arc of 60°. But ordinary (not excessive) rolling bothers the mastheaders comparatively little; it is the pitching that gets them." To give the lookout men more security than that of the grasp of their hands, and to leave their hands somewhat free, they are secured to the rigging by belts such as window cleaners use.

In the picture note that the wooden platform is secured to timbers which are lashed fast to the bowsprit. Thus when the swordfishing season is over, the pulpit and supporting timbers may be removed *in toto* and the unhampered vessel put in shape for seeking cod, halibut, mackerel, etc. From foot-rest and timbers, iron supports extend upward and have at their outer ends a three-quarter circle of iron to support the harpooner when in action. There is a swinging seat in the open rear part of the circle and, when the boat is cruising around, the striker sits thereon and "takes it easy" until a fish is sighted.

The fish heeds not the approaching schooner but turns a great and unsuspecting eye upward, ignorant of impending doom. On the boat all are on the *qui vive*, as the striker, with tense arm and calculating eye, drives the iron into the back of Xiphias. "Good iron, that!" the skipper calls out, as the disillusioned fish makes off. The shaft is retrieved by the upper line; when the harpoon line has about run out, the keg is tossed overboard. It acts like the "drogue" on the wheelman's harpoon line, and it also enables the lookouts to follow the erratic course of the stricken fish.

These larger and improved "sword-ers" with Diesel engines, when compared with the old-time sail-driven boats, are not only speedier but are more easily maneuvered to put the striker on the fish. Then with a masthead full of keen-eyed lookouts, many more swordfish than formerly will surely be taken. Thus, according to R. C. Osburn, 684 fish were brought into Boston's T-wharf in one day, 707 on another day, while one schooner brought in 202 from one "trip." The year 1929 was "high catch" for all time to date in New England—6,069,000 pounds of swordfish were brought into various ports during the season.

From this mere sample of the statistics of the New England swordfishing for one year, one may get some small idea of the growing density of commercial swordfishing in these waters over the past seventy-five years. This will give the reader a background against which to expect a large number of (retaliatory?) attacks by the fish on fishing boats large and small. There must have been hundreds if not thousands of such attacks, but the fishermen take them as a matter of course and comparatively few have been recorded.

DANGERS FROM HARPOONING SWORDFISH IN NEW ENGLAND WATERS

The harpoon method of taking the swordfish in New England waters has been given and the romantic aspects of the fishing have been pointed out. Now the other side of the picture, the dangers of this harpoon fishing, will next be considered. Undoubtedly hundreds of attacks by the fish have taken place, but of these only a few have been recorded and of the published accounts only those will be quoted which particularly illustrate the perils to the fisherman.

As has been shown above, from the time of Polybius (*circa* 100 B.C.) to the present, belief in the pugnacity and vin-

dictiveness of *Xiphias* has been widespread. In another paper I have considered at length the matter of the alleged pugnacity of our fish as shown in attacks on vessels all over the seven seas. Just here attention will be given to attacks on schooners and their dories in the New England region. Later this alleged ferocity will be studied in the light of the psychology of the fish and an effort will be made to get at the facts.

Schooners Rammed.—The swordfish is an active and powerful antagonist and apparently no respecter of wooden vessels. There have been published many accounts of his attacks all along our North Atlantic coast. But herein our attention will be confined to accounts of attacks on swordfishing vessels off New England, which have been frequent. Thus one captain reported three swords stuck in the planking of his vessel. Another vessel is reported as having eight swords in her hull at the end of a season. And another was struck twenty times in the course of one summer. If all these swords had remained fast in the hulls of these vessels, then when October came the schooners might well have been denominated "swordfish pincushions." When the sword is driven into a seam between two planks, leaks are likely to result.

Swordfish attacks on fishing vessels may be delivered on any part of the vessel. Thus there is a record of a *Xiphias* which drove its sword into the schooner's rudder. But since we are dealing here with perilous attacks, the accounts to be quoted will be confined to those of ramming of the bows of vessels, since here there is danger to the fishermen in the forecastles.

Schooners Struck in the Bow.—Since *Xiphias* is harpooned from the bowsprit and, until the keg is thrown overboard, is tethered to the bow of the vessel, it would seem that he would deliver most of his attacks to that part of the schooner.

Thus it is reported that one such harpooned fish, when brought to where he could see the splash of water around the forefoot, turned and rammed the bow just below the water-line.

Here are some other accounts of attacks on the bows of schooners. Thus when a swordfisherman went down into the forecabin in the bow of his schooner to get his suitcase out of his bunk, he found it stuck there—pinned fast by a sword driven through the hull. Another man had the mattress in his forecabin bunk ripped open by a sword driven through the planking. One shudders to think that these rammings might have taken place when the men were sleeping in their bunks.

About seven years ago Captain Nels Amero, of the "Doris Amero," of Gloucester, Mass., harpooned a swordfish in the head. The fish, seemingly crazed by the blow, swam directly at the bow of the boat and drove its sword through a three-inch white oak plank in the hull and a three-inch hard pine board in the inner ceiling of the boat. These planks had to be replaced when the schooner came into port.

In July, 1937, Captain Bert Poirier, also of Gloucester, Mass., had an interesting experience with a swordfish, which he has kindly communicated as follows:

We left Gloucester, headed for Browns Bank 250 miles away. Upon reaching the swordfish grounds, we harpooned and brought in several fish without incident. Soon after this we sighted a swordfish finning high. At this time six men were aloft on the topmast. The striker was ready with the harpoon, a man stood by with warp and keg. I was at the wheel with my assistant.

The striker ironed the fish back of the fin, and he whirled around awhile and then headed for the boat at top speed of about forty miles per hour, and struck our bow just forward of the chain plates. The sword was driven in nearly up to his eyes. It went through two and a half inches of white oak and three inches of hard pine ceiling, and we had to cut off about one and a half feet of sword inside the ceiling. When we hauled the fish aboard it was dead. The boat had to go on the railway for repairs.

Last of such attacks to be recorded here is in an account communicated by Mr. Hand. This will help make clear some of these seemingly vicious attacks on the bows of swordfish. In 1923 or 1924 his schooner "Blue Goose" was rammed in the following interesting fashion:

We met the swordfish "head and head." I harpooned it from the end of the bowsprit in the conventional manner. Whereupon it jumped ahead, striking the bow of the schooner with sufficient force to put its sword through two inches of hard pine planking, a space of about five inches, and then through three and a half inches of hard pine ceiling, so that the sword projected about eight inches inside the hold. It broke off close to the outside of the hull, causing considerable leaking. I have the piece of plank with the impaled sword in it.

These and other accounts of attacks on other parts of schooners are of not uncommon occurrence. But it must be said that considering the number of swordfish on the grounds, and even more the total number of trips made and the number of fish struck each season, the ramming of schooners is of relatively unusual occurrence in comparison with the much larger number of assaults on dories on the fishing grounds.

(To be concluded)

FACTS AND PHILOSOPHERS

By Dr. J. A. GINGERELLI

DEPARTMENT OF PSYCHOLOGY, UNIVERSITY OF CALIFORNIA AT LOS ANGELES

It is not too much to say that for the overwhelming majority of scientists philosophy connotes a sort of intellectual catch-as-catch-can with no holds barred, a domain of pure verbalism where it is possible to assert opposites in the same breath and ask all manner of idiotic questions. This belief is embodied in the well-known witticism which defines philosophy as a blind man looking in a dark cellar for a black hat that isn't there.

Now there is a reason for this; for in the history of philosophy will be found pious mouthings and nonsense sufficient to corroborate this opinion a hundred times over. Indeed, the only acquaintance which the average man of science has had with philosophy is usually a course in its history in the fall of the year when he was a romantic sophomore. He remembers vaguely that it began 'way back with the early Greeks who were eternally wondering about the nature of the universe and of man and of their relation to one another. Then there was something about somebody who said that there was two of everything; one the original and the other the copy. The originals were supposed to be ideas and they were kept all in one place. The copies were the things one sees and bumps into such as teacups and chairs, and these were not real because they were only the images of the real things. After this there is a long stretch for which he remembers nothing very definitely except that by this time in the semester it rained most of the hour and the professor kept mumbling something about nominalism and realism. He may recollect in a vague way that both the professor and the textbook were very secretive on the subject;

but there *was* something to the effect that the chair you were sitting on was not real: that the only real was *Chairness*. When the semester came to its weary end, the estimable man who gave the course was telling about a famous philosopher—some Frenchman or German—who contended that when billiard ball A hit billiard ball B, the latter moved, not because it was struck by billiard ball A, but because God, at that precise instant, decided to make B move in that particular direction and at that particular speed. Ball A had nothing to do with the matter. The fact that billiard ball B never moved unless it was struck by another ball or by a cue stick was irrelevant to the argument: this merely proved that God decided to make B move only on such occasions. The last thing our scientist may remember about philosophy is grabbing up his books after finishing the final examination and fleeing from the room with a panicky feeling for his sanity. Needless to say, he never took the second semester.

The cream of the jest, however, lies in the fact that had he persisted in the face of his better judgment and enrolled for the second half of the course, by June the professor would be discussing Hegel, and by this time our embryonic scientist would be a gibbering maniac.

There can be no doubt, it is true, that the reputation which surrounds the subject of philosophy has been fairly earned. But then we must bear in mind that the history of no subject presents a very pretty spectacle. One can very well imagine how an astronomy major would react to a required year course in "The History of Astronomical Concepts from the Early Egyptians to Copernicus," or

the feelings of a physics student toward a semester three-hour course on "The Pythagorean Theory of Tones." And if we were to make a course on "The Leading Concepts in the Chemical Thought of the Middle Ages," a prerequisite to Chemistry 1A, it would not be hard to predict the frame of mind with which students would approach this subject.

There are always great dangers in estimating a subject from its mere chronology, and it has been perhaps the besetting sin of philosophic instruction in the western world that it has been approached from the historical point of view. The young mind is presented with the *fait accompli* of someone's system of ideas without the slightest preliminary rhyme or reason—with such effects as we have tried to describe.

II

It has become a commonplace to say that we live in a scientific world. If you ask what this phrase means, you are likely to get the answer that we live in a world which is dominated by the products of scientific thought. When you inquire as to whether there is something unique about scientific thought which serves to distinguish it from other kinds of thought, the answer usually is not so prompt. Possibly after several false starts, your informant finally decides upon *factuality* as being its single most distinguishing characteristic: enlarging upon this proposition, he points out perhaps that science arose when men set their faces against accepted beliefs, however hallowed, and proceeded to observe the actual facts of the world about them. He may say as follows:

I can make the matter clear by an example; science differs from philosophy or theology in that science has to do with the careful observing and tabulating of the phenomena which constitute the various effects of the universe about us; whereas the latter two have to do with suppositions and beliefs. To think scientifically means to have a clear, precise and impartial grasp of

the facts and to manipulate these facts to serve some purpose. To put it in a word, the essence of scientific thought might be said to be objectivity.

Now if our friend happened to be the same gentleman whose unfortunate experience as a tender sophomore we recited earlier, he might, by this time, be warmed up to the subject, and could very well continue in this wise:

For instance, there was a philosopher who contended that there was a world of ideas and a world of objects, and that the world of objects was an imperfect copy of the world of ideas. By what right does a man make such a statement? What *evidence* is there for such a belief? This is as good an example as any of the difference between philosophers and scientists: no scientist in his right mind would think of coming to such a conclusion; his conclusions are always based on *facts*, and the facts at our disposal do not justify such a belief.

The matter could hardly be put more bluntly. Let us therefore open our window and look out at the "facts" of the world. We see palm trees lining the avenue. At one side of the road there is a truck piled high with yellow boxes. These are a few of the multiplicity of details which you might cite as objective facts. I am at your side and agree with your description. But it is permissible if I ask a question. I want to know if the truck is there when we are not looking. You have a longstanding acquaintance with my whimsies, and therefore are quick to fall into the spirit of my question. You point out that the question must be answered positively, for if we stationed a person in front of the truck with instructions to stare at it continuously, he would later report that during the period when we were not looking the truck continued to be present. To make your answer even more conclusive, you suggest as an after-thought that an automatically operated motion picture camera could be stationed in front of the truck. Subsequent examination of the developed film would show the same image on each frame. But now I

ask another question: "How do you know the images are on the film when you are not looking?"

This, of course, is the sort of thing which drives the scientist as well as the layman into tantrums of impatience. Unfortunately, impatience does not imply here anything except the fact that you are impatient. Most of us were impatient when we learned that Euclid defined a line as having length but no width. You, as a hard-headed scientist, take nothing for granted: it is therefore necessary for you to decide what is and what is not taken for granted when you have dealings with a fact.

Now you can be as tough-minded as you please about my question: in fact, the more tough-minded you are the better I will like it. But if you are half the scientist you think you are, you will answer it, and you will answer it scientifically, that is to say, you will answer it clearly and unambiguously, and in a manner which is in harmony with the most scrupulous regard for the facts. If you refuse to answer it, it means that there are dark empty spaces in the texture of your thought and knowledge, and one day, sooner or later, you will have to reckon with them. One may consult Einstein and Heisenberg for corroboration on this latter point. Should you, however, follow your better judgment and decide to answer the question clearly and unambiguously, you will be surprised to learn how much of what you regarded as obvious and a matter of elementary fact, is neither obvious nor factual. It is not my purpose now to make any suggestions in regard to the matter; but one thing is certain—the problems which you will face here are not of the sort which can be answered by looking more sharply at a galvanometer scale; or using a microscope of higher resolving power. Not all problems which face the student of nature are brass instrument problems; some are of the sort

which misinformed people call intangible or "metaphysical." But intangible, "metaphysical" or what you will, they arise in spite of all you can do. They are inevitably part of your business as a student, and you must make your choice as to whether you will consider them sharply and with full consciousness, or whether you will consider them in a somnolent logical haze. You may rest assured that if you do not do one, you will certainly do the other.

It may be felt, perhaps, that the question of the existence of the truck is too far-fetched. If this is true, it is only because you feel strongly on the subject. Let us attempt a more suitable example of a fact which is not a fact. It is frequently asserted that electrons exist. Perhaps one of the most direct experiments which is said to prove their existence and their idiosyncrasies is the famous Millikan oil-drop experiment. In this experiment a cloud of oil particles is blown into a chamber which is lighted by a slit. If you look through a suitably adjusted microscope you will see bright little points of light floating in space against the background of a co-ordinate system which enables you to fix the position of any particular one which interests you. At first they fall downwards under the influence of gravity. But if you press a button which turns on an appropriate electrical field, the points of light drift rapidly upward. You can determine how far the one you are observing travels in a given period of time. You test it again and again, writing down in your notebook the distance traversed. Then perhaps you press another button and reverse the field. This time the points of light move furiously downward, since now they are affected by the *sum* of the gravitational and the electrical field. You proceed as before. The experiment goes on for days. When you have finished you will have columns of figures which are

distances and times. After you have made the proper calculations on the basis of these figures, it is evident that there is a minimum value, and that all other values are integral multiples of this minimum value. That is to say, if your minimum value is x , then the other values will be $2x$, $3x$ and so forth. A thrill of excitement goes through you; you have corroborated the "existence" of the electron.

But what is the thing whose existence you have corroborated? Certainly the bright points of light were not the electrons. They were only oil drops. You say that you have proved the existence of a minimum *charge* of electricity, a unit charge so small that all other charges are multiples of it. But what manner of thing is this charge: what can you say of it? There is only one thing which you can say which is a matter of scrupulous fact—a charge is whatever it is that is on a particle which makes that particle accelerate in its motion when you turn on an electrical field. This is what people have in mind when they observe that modern science does not know what electricity *is*, but knows what it *does*. This cliché illustrates so clearly the profound misunderstanding which hard-headed people have of the world of facts. The truth is, of course, that modern science not only knows what electricity *does*, but knows what it *is*. It is *that which* has the idiosyncasies described by the differential equations in books entitled "Electricity and Magnetism." For what would we know if we knew the "intrinsic nature" of electricity? Would we like to know whether it is thick, grey, oblong or three-dimensional? Surely thickness is no more real than the fact of increased acceleration under denotable conditions!

In the last few minutes we have been philosophizing. However, if you infer from the preceding that you should not be hard-headed and factual about the

universe, your inference is about as wrong as it could possibly be. The intention was, rather, to demonstrate how necessary it is to be factual, rigorous and tough-minded. But the moral of the tale, of course, is that tough-mindedness and faithfulness to the facts leads one to strange places and makes one say things which seem quite the opposite of what one might suppose is good solid sense. In fact, if you do use good solid practical sense, you are likely to end up saying things which will sound "unscientific" and "philosophical."

To infer, on the other hand, that philosophic thought by its very nature has a monopoly on rigor and hard-headedness would be, as we have seen already, equally erroneous. There is, indeed, but one acceptable statement which is to be made in this connection; namely—that all rigorous and hard-headed thought requires rigor and hard-headedness in thinking. The difference between the domain of philosophy and science is of the same sort as the difference between physics and chemistry, or biology and psychology, or geology and botany. The difference exists by virtue of the difference in the questions which are asked. The human mind, when it works effectively, works everywhere in the same way, that is, clearly, sharply, taking as little unconsciously for granted as possible.

The questions which are asked in philosophy have perhaps, as their only claim to uniqueness, their excessive generality. It is obvious even to a tyro that the question: "What makes solid objects move?" is a less general question than the one "Is the world which we know good or bad?" You may, it is true, think the latter a foolish question; but what mass of analysis, labor, definition and redefinition intervenes between the posing of the question and its final evaluation! It may be said that the generality of the questions which arise in philosophy

reaches its acme, perhaps, in the question "What is a permissible question?" If we must have a phrase, it might be said that philosophy is that domain of thought which occupies itself with the most general questions which are raised by the human mind. It is unfortunate, of course, that not all the questions which face the intellect are concrete and particular and at the level of our habitual perceptions, but such is the sad and inevitable fact.

III

In the meantime, the widespread notion that science has to do with the tangible and concrete and therefore the good and useful, whereas philosophy has to do with the intangible, and therefore the bad and impractical, presents itself as an obstacle to the realization of concrete and practical results in science itself. For if philosophy which has to do with the non-concrete is bad and unscientific, then any question which is not concrete, which has to do with things "you can't put your finger on," is not a scientific question, and belongs to philosophy. There has grown up, particularly in America, what might be called the field-trip view of science. You have your knapsack at your side, and as you walk along, you keep a sharp eye out for a good fact which you promptly stuff in your bag. When you get home, you line up your facts on the table, and see if you can make any sense out of them. It is not easy to say what is responsible for this quaint view of the nature of the scientific enterprise. It would probably be safe to assert that it is a hangover from days when science was young, that is to say, when men were not yet on a speaking acquaintance with the world in which they lived. In those days, of course, there was little else they could do except rubber-neck. As a beginning, one must always merely gawk at a thing as objectively and impersonally as possible: beyond a certain point, however, when one

has mastered the general outlines, there begin to arise a thousand details, and if we continue to merely record them in our notebooks as objectively and photographically as possible with what we consider to be true scientific fervor, we discover, to our dismay, that we are never done. What is far worse, we find that these "facts," which we treasure so highly because they are so objective and factual, begin to display a curiously perverse property. They very frequently contradict one another. Logs float and stove lids sink; but battleships, which are made entirely of steel, float too.

The contradictions arise, of course, by virtue of the fact that we try to make our eyes do the work of our heads. Perceptions can not take the place of abstract ideas. It is true that abstract ideas which do not refer to perceptions are mischievous; for they are, except in a very restricted logical sense which does not concern us at the moment, neither true nor false; but a great many respectable scientists seem to go on the assumption that abstract ideas as such are to be avoided because as a class they have a philosophical tinge. The complaint is that they do violence to the "facts" and substitute a metaphysical fiction for a concrete reality. Fortunately for science, most workers do not carry this belief with them into their laboratory; for if they did, physics, for instance, would still be where Thomas Aquinas left it.

It is a curious commentary on the structure of the human mind that a man can come away from the development of a differential equation and contend in the next breath that a scientist deals with facts and only with facts. One of the simplest differential equations of physics, that which enunciates that the acceleration of a body is constant in the gravitational field of the earth, when free from other influences, is separated from the simple fact by a long train of remarkably abstract ideas. For, as you are well aware, if you were to test this

in an ordinary room under ordinary conditions it would not be so. If you let the body drop in a tube from which more and more air were removed, you would find the law more and more in accord with the phenomenon. Unfortunately, you can not prepare a tube which is an absolute vacuum; hence you never succeed in perceiving what happens under the conditions which are specified by the law. What you do, however, is to resort to the rationale of *limits* and in that way you employ a logical pole to vault over a factual obstacle.

Perhaps the single most dramatic law of nature, Newton's First Law of Motion, the well-known proposition that a body in motion continues in motion in the same straight line and with the same speed unless influenced by some external factor, represents at the same time the most dramatic flaunting of the facts as they are perceived objectively and photographically. It took genius of abstract thought to conceive this; keen eyes would not have been enough. It is as if Newton took the universe of perception by the scruff of the neck and jerked it around to assume a posture more to his liking. It is doubtful if Plato's realm of pure ideas can be considered such a brazen transcending of the world of pedestrian fact. The chief difference between those two pieces of intellectual effrontery is that if you denied Plato's it might not make a bit of difference in anything except your attitude toward Plato; whereas if you denied Newton's it wouldn't be possible to predict eclipses so nicely.

One could go on, citing example after example in that domain where man's insight into the universe is acknowledged best, namely, physics, and show that it literally bristles with the most fantastically abstract ideas—sheer constructions, about which, furthermore, are organized those routine facts which come to people's minds when the word "physics" is

mentioned. These ideas are the frame of the whole structure: were they to be removed, the whole system would come toppling down into a pile of unrelated, contradictory fragments.

We have perhaps written and read so many elementary science text-books for high school and college freshmen that we have come to believe their easy metaphors. You turn to the chapter on dynamics in some text-book on "Beginning Physics," and time and again you read the disarming phrase "A force of K pounds is applied to the point X." As if a force were like a mustard plaster or a poultice! Little wonder students of science come to think that in science you deal only with pure facts which can be seen and felt. The fact is, of course, that a force is nothing in particular. It is a conceptual entity; it is *that which* gives a body of a given mass a certain acceleration. And if you were to ask questions about mass itself, there would be an even prettier story!

Psychology furnishes a clear example of the mischief which may be wrought by the misleading emphasis on what Whitehead has so aptly called "misplaced concreteness." In psychology we have amassed a staggering quantity of data, and it is piling up at an ever-increasing rate. Since it is the latest of the sciences to arrive, it was not slow in appropriating the equipment which had been forged by the other disciplines. There are galvanometers, vacuum-tube amplifiers, oscilloscopes, methods of statistical analysis, surgical techniques and many more which are available; and it must be said that, in general, psychologists have learned to use them rather well. The facts which have been accumulated are, on the whole, undoubtedly correct, but they have so little intrinsic relation to one another! If you are giving a course on motivation, for example, there is ample experimental material. You can cite Warden's experimental re-

sults with rats, showing that hunger was more potent than sex in causing a rat to cross an electrified grill; or Hurlock's findings that children who were praised or punished learned better than those who were neither praised nor punished; then there are Elliot's experiments which show that hungry rats were reliably slower in learning the maze when at the end of the run they found only water, than were hungry rats who were given food at the end of the run. There are investigations demonstrating that competition between two persons will increase performance for each to a greater degree than will competition between two groups of which the two persons are respective members. Going to the field of applied psychology, it is possible to indicate experiments where a slight bonus served to increase by 75 per cent. output in employees who had been members of the firm for twenty years. It is possible to cite good experimental evidence of this sort right up to the end of the semester.

But, clearly, all of this is back work. There is no conceptual backbone from which the data may be suspended: hence the whole enterprise lacks drama and significance. If the course is to have any interest or intellectual dignity you must supply this. This means that a set of definitions and concepts must be constructed which the dumb facts as such can never specify. Unfortunately, frames of concepts and definitions are not to be had for the asking. You will have to determine, first, what it is, if anything, which makes motivation a phenomenon distinguishable, let us say, from ordinary habitual action. When this has been accomplished, you are ready to ask the question, under what conditions does the phenomenon of motivation occur? Everything is going smoothly; you have constructed a tentative hypothesis, when you are reminded of a set of phenomena which

flatly contradict the careful structure you have erected. It isn't as if you could carry out an experiment which would throw additional light on the subject: the situation is not of that sort. There exist data aplenty, but they do not square up with your concepts. The saddest part of the whole matter is that practically all the other data fit in very nicely. It is obvious that you must change your conceptual structure. Now if you are sufficiently clever or fortunate, it may dawn upon you one day that the question which you are trying to answer may be negotiated if you look upon the phenomena of motivation as a special case of a more general set of phenomena. You then set to work to carefully define this more general set, and draw out the implications which follow from it. If luck is with you, eventually you may even succeed, and at that moment you are vouchsafed one of the great experiences in the domain of the intellect. A segment of the world which before was a slipshod, indifferent jumble of details now snaps into form and order; you have the thrill of perceiving that certain things of common knowledge which you had always supposed had the closest intrinsic relation to one another, are not related at all, whereas others, which on the surface seem worlds apart are exemplifications of the same thing.

But when you have finished and the first flush of excitement has passed, you are likely to look aghast at your own handiwork. How everything is changed! The old familiar black-and-white distinctions have vanished; the easy landmarks, the self-evident suppositions, the comfortable little paths worn smooth with constant retreading, have been obliterated; in short, the whole mass of clichés with their aura of warm common-sensicality is no more. In its place you have a cold, formal structure, which seems totally irrelevant to the original enterprise.

Precisely for this reason, structures of this sort are not exactly in favor in psychology. They are considered in the nature of quasi-philosophical speculations. Only recently psychology succeeded in separating itself from philosophy, and we must justify the divorce! We must collect facts, more of them and more accurate facts; when we have a great many of these, the relations will become evident enough. In consequence, the energies of psychologists are spent in collecting more data and devising clever experiments. Sometimes the experiments are very clever, but then it is never quite clear what the results demonstrate. There are, in other words, too many psychologists who seem to think that we must collect all the "facts" about human nature. This, of course, is impossible. Every new individual will bring to our notice some new quirk of "human nature," and we shall never be finished. To stare at the universe and note down ever so carefully what you see is not the procedure of science; nor is it much better to perform well-controlled experiments at random. What usually happens in such instances is that we control the wrong things.

In psychology, as in physics, we must approach our material equipped with more than sharp eyes and good instruments. We must approach it equipped with abstract ideas, with concepts which are capable of standing our universe of familiar experiences on its head if necessary. We must not, in other words, be afraid to use our imaginations. This fear of the formal, the imaginative and the abstract in science is doubly extraordinary when we consider that we find these tabooed qualities most prevalent in physics, the most impressive and successful of the sciences.

It is instructive to consider the concept of matter in this connection. Every one knows what matter is! It is the stuff the world is made of. It is usually hard,

resistant, takes up space, is heavy, sometimes impenetrable, it has shape and size. Indeed, every one knows it so well that it hardly presents a problem. The difficulty lies precisely in this universal familiarity with matter and its attributes. Because of this, many centuries passed before physics came into being: as long as men persisted in looking upon the most outstanding characteristics of matter as being its wetness or dryness, its hardness, its impenetrability, its weight; in short, as long as men thought of matter in terms of its most familiar attributes, there was very little understanding of the material universe. Understanding came only when it occurred to Galileo and Newton to identify matter with the attribute of *mass*.

Now mass, as the physicist understands it, is one of the least obvious of the attributes which a good factual observer would note in matter. Indeed, it is an attribute so undramatic and imponderable that many professors of physics are impelled, in their beginning course, to dress it up under the delusion that by so doing they are "getting it across" to the student. In consequence, they make such statements as "Mass is the amount of matter contained in a thing." What such a professor is "getting across" is not entirely clear; certainly, it is not the concept of mass as it is understood and used in dynamics. Mass is not the amount of matter, for the simple reason that it is impossible to measure the amount of matter except by measuring mass. And when you measure mass, you measure not the *amount of a stuff*, but the amount of a change in the velocity of something. In other words, the mass of an object is measured by the acceleration which a given defined event gives to that object. It will not do to say that the acceleration is *an indication of the mass* of the object; it is the mass of the object. To be even more brutal, the mass of an object is a num-

ber, and this number is obtained by measuring accelerations under certain conditions.

You may, if you insist, retain the belief that mass is more than the measured acceleration under the conditions defined; that, in effect, the measured acceleration is a reflection of the mass. But if you do, there is no telling what good it will do you. Indeed, you are merely insisting on the privilege of holding the belief *that there is a something which is described by an acceleration*. This is rather silly, because there is no need for it. All you need to do is to say that there is, *e.g.*, a billiard ball which under defined conditions obtains an acceleration of n units, and that this is what you mean by its mass. To conclude, this number, which is a description of an acceleration, is the single most important attribute of the billiard ball which is known to science.

Could anything be more bizarre, more contemptuous of the data of the senses! Yet, by picking out, indeed, *formulating*, this attribute of matter in this way, it was possible, in a relatively short time, to create the whole majestic structure of classical mechanics. As if by magic the macroscopic aspect of the whole material world becomes unified under a few simple ideas.

Such are the fruits of intellectual audacity and abstraction! We must never forget that sooner or later, in each and every science, the time will come when hypotheses must be framed which fly high over the familiar pedestrian landmarks of everyday experience. We can not forever be discovering a new nerve ganglion or finding a new plant! It is necessary to observe, but it will inevitably happen that we shall discover ambiguities in our observations. It was only the other day that men came around to persuading themselves that two persons could stand on the opposite surfaces of a spherical earth without either one of them falling off or feeling upside down.

In psychology particularly at this time there is a pressing need for hypotheses of this sort to reconcile the contradictions and ambiguities in the multitudinous carefully accumulated facts. There is need for philosophizing of the most rigorous sort; for the posing of general questions: "What can it mean to understand human nature?" "What can it possibly mean to understand anything?" "What are the necessary and sufficient characteristics of an explanation?" These are not idle unscientific speculations. On the contrary, they are of the essence of the scientific method. It is precisely because we are not clear about them that there is not at the present time among psychologists a fundamental agreement as to how to approach this simple question: "Under what conditions will a person obey the command 'Wiggle your finger.'"

IV

It is clear that there is no place where science stops and philosophy begins. If we insist upon creating an artificial dichotomy of this sort, we do ourselves a great deal of mischief: it can only result in bad scientific method and worse theory. If we would gain an insight into the problem of the relationship between science and philosophy, we have but to ask ourselves this question: What does the human mind attempt to do in its efforts to understand the universe? The answer is that it tries to embrace as many experiences as possible under the fewest possible rubrics with the minimum number of contradictions. This is the basic impulse behind the efforts of all thinking men, be they physicists, biologists or metaphysicians. If we do not keep this fact clearly in mind at all times, we are likely to create for ourselves no end of silly problems and misleading convictions.

It is precisely for this reason that the quarrel between experimental scientists

and philosophers is so badly focused. Some laboratory men, for instance, fancy that their quarrel with philosophers lies in the fact that the latter are so theoretical. This is nonsense, and shows among other things that such experimental scientists do not thoroughly understand their own business. There is ample reason for quarreling with some philosophers, but it is not because they are theorists; it is because they are *bad* theorists. We wish to embrace the universe with as few rubrics as possible, it is true; but if a philosopher comes and announces oracularly that "The Universe is One," we can not but be slightly nonplussed, even though we may admire the utter simplicity of his system. We are nonplussed not because he is so abstract and theoretical, but because he did not say Two, or Three. Like all thoughtful men, philosophers have understood only too well the need of the human mind for generality and simplicity, but very few of them have seemed to understand that a rubric, after all, is a man-made thing and that you can make as many of them as you please. Therefore, most philosophers missed the point which came to be realized with increasing clearness by that group of thinkers and workers later known the world over as *scientists*. These men realized that a rubric must command respect; and there is only one way in which you can command a man's respect, namely, by appealing to his senses. In effect, science is that mode of classifying the universe which makes of perception the last court of appeal.

Unless we adopt this point of view, we are cast upon the boundless ocean of sheer logical construction, where we can make as many rubrics and systems as we please. These systems, as systems, are neither true nor false; they are internally consistent, some are simpler, some

are more complex, but of them, whatever their nature, only one statement may be made: They are! It has been the mistake of many philosophers to suppose that their systems could be shown to be true, whereas they had the great misfortune of belonging to this class which transcends perceptual corroboration.

This characteristic of many of the classical philosophical systems has earned for them the opprobrium of being useless. So far, so good! But the mischief arises when it is supposed that they are useless because they were so theoretical. We now know that they are useless because they were not theoretical enough. These men did not understand what might be called the Theory of Theories. They did not understand that the phrase "To be true in theory, but not in practice" is a literal contradiction in terms. It is in this sense that we are to understand the proposition that there is no place where science stops and philosophy begins. Science must not be looked upon as a sort of rebel step-child of philosophy. If we must have metaphors, we should rather look upon science as philosophy come of age and into the gradual possession of its adult powers.

Indeed, it is hard to understand what people have in mind when they distinguish so emphatically between science and philosophy. It is certain that the science they are thinking of is not science at all but technology. The very great scientists are all great philosophers in the one and only significant sense in which the term may be used, namely, that they tried and succeeded in imposing upon the universe of kaleidoscopic perception, concepts and principles which made it simpler and more orderly. The illustrious names of Galileo, Newton, Darwin and Einstein come immediately to mind.

THE SCIENTIST AND SOCIAL POLICY IN THE DEMOCRATIC STATE

I. SPHERES OF INFLUENCE

By Dr. CHARLES E. KELLOGG

PRINCIPAL SOIL SCIENTIST, U. S. DEPARTMENT OF AGRICULTURE

THE growing tension in the world forces the citizens of democratic states to look to their own social organizations. Despite great material progress, there is unhappiness, distress and uncertainty. Raving demagogues, whispering propagandists, shouting patriots and whimpering sentimentalists nearly threaten to smother the reasoned discussion of earnest citizens.

The ideas expressed here have come out of books, and discussions, and perhaps a few from experience. They do not comprise a complete system (if there is one). The attempt is to discuss, as simply as possible, the more critical relationships of the scientist to the modern democratic state.

The writer feels very strongly that the future of democracy, and all that goes with it, depends upon the strength, vitality and adequacy of this relationship. Although agreement upon ways and means is not asked for, earnest consideration of the principles involved by young scientists is anxiously hoped for, while there is time.

THE FLOOD OF CHANGE

Change is the rule in human affairs—changes in art, in science, in politics, in moral values and in folk ways. And sometimes waves of change pile up on one another, like great tidal waves that threaten all our ideals and traditions. Glancing back into history, we can see these periods and see how complexity overran complexity until old and trusted patterns of social organization broke down before the new were strong enough

to serve. Whether we are on the brink of such a period, or well into it, no one can say now. Likely future historians will simplify our period into a few forces and clashes, and show how certain results—results we can not now foresee—were inevitable. But each of us has too many unconscious assumptions of purpose and prejudice for clear conceptions of the things to come. Like the others before us, we must struggle as best we can with what we have. And we have much.

Not only have we much, but a great variety. The changes in time pile over changes in space. The Mississippi Valley, for example, not only was developed later than New England, and hence differently, but the environmental pattern required different arrangements for use. In the peculiar pattern of southwestern deserts, mountains and plateaus, local Indians, early settlement and Spanish colonization all had a part in producing a different cultural area than in the Great Lakes region or in the Coastal Plain of the Southeast. A social idea or a scientific principle may be important in one of these regions and irrelevant in another. The objectives of democracy, and the use of science to help attain these objectives, follow different courses to their goals. Some of the differences in space may be related to time changes; many are not; and no amount of time can bring a continent to cultural uniformity. Attempts to do so by military forces, or other forces, can bring misery to the people and exhaust the resources, but differences will remain. Sectional conflicts are always arising in a dynamic

world, conflicts that can be solved only by that proper balance between national or continental solidarity and local autonomy.

Each day in each place presents a new combination of facts and forces; each idea overlaps with others; each new thing crowds upon other things. Since the world is no vacuum, each new element wedges itself among the old, to squeeze or to be squeezed, to replace or perish. The new may be accepted side by side with the old, still honored with reverence, and the two inconsistent with one another, like the war profiteer who wills his fortune for a peace memorial. Patents are protected by law, and in other laws monopoly is condemned. Often one can't play new games under the old rules. Look at municipal governments in America! The centralization of social services, for example, calls for new concepts of the public trust. The standards of common honesty for the official of a Colonial village, handling a few dollars under the eyes of his neighbors, were ever so much less important than those of the official in a modern city, dealing in millions spent for technical services. The rules guiding the personal relationships of employer and employee in the wagon shop of a previous century have little application in the automobile factory of to-day.

New inventions raise far-reaching questions. New laws are required, or old ones need revision, if the basic social objectives of the society are to be realized. The American Constitution recognizes that the Congress has a function to perform in regulating navigation on the inland waters but obviously had nothing to say about the use of streams for hydro-electric power; not because the framers of the Constitution thought to reserve this responsibility to the states or local governments, but because the question hadn't arisen. Nor did they see fit to prohibit the possession of machine guns

by individual citizens. Neither Jefferson nor Franklin nor even Lincoln discussed the problem of trade unions in huge mass-production industries using the assembly-line technique. In one social and legalistic framework new inventions may advance the objectives of a democratic society, in another the same inventions may retard them.

These questions are not only ones of morals and justice but also ones of technology and economics. They are neither one nor the other. They touch our folk ways and our emotions at many points. The very words "democracy" or "totalitarianism" call forth emotional responses in most of us. They are closely related to freedom, security and patriotism. Should America substitute some other political principle for democracy it would be done under a banner of "freedom," "security" and "country."

It is much easier to resolve the questions superficially in our minds with pleasing platitudes, drawn largely from philosophers of previous ages—philosophers who scarcely dreamed of radios, machine guns, synthetic fertilizers, zippers or flying machines, much less of the problems created by their manufacture, the desires of people to have them, and their use in a more densely populated world. Even in doing that, we may confuse their statements of objectives with those of recommended action for their own current period.

The early advocates of democracy lived in non-scientific ages. Science is absolutely essential in the modern world. This doesn't mean that scientists could or should run the world. One aristocracy would be as bad as another. But their skills are essential. Those same skills that play havoc with our old patterns of living may be used to create new dynamic patterns in which all men can live in peace and justice. This means responsibility for the scientist—responsibility to know, to work with others and

to appreciate the relevancy of his skills and principles.

The challenge to scientific men and to all men who use scientific skills is enormous. Like others, they can see these great strains and cracks within the social structure due to changes, unequal changes, in our techniques and ideas. We have often thought of science as something that is changing the world. It has. But it is more important now that we think of science as something to help make the changes evolutionary rather than revolutionary. Heaven knows it is changing—changing unevenly in different places—nothing can stop that, however much we wail or curse. But how can these changes be guided? How can the parts of our culture be fitted and be kept fitted as we move along?

Certainly if we avoid catastrophe scientists must help supply the answer. And do this while there is time.

PRIVILEGES AND RESPONSIBILITIES

Much political complexity can be hidden or ignored by the words democracy and totalitarianism; yet the distinction is helpful, providing neither is used in a completely exclusive sense as applied to any particular state. Between black and white there are many grays. Probably the scientist's concepts of these forms of social organization are not fundamentally different from those of other people. Yet the growing significance of scientific principles and skills in modern society has given scientists such an increased responsibility that they need more than ever before to know where they stand. Much has been said about their privileges, but more emphasis needs to be given their responsibilities.

Democracy is assumed to mean, generally, a dynamic form of government in which the individual has an opportunity for self-expression and for the optimum development of his abilities and

tastes, consistent with the general welfare, as determined by the majority after open debate. Under such a system the government has the duty of protecting the rights and opportunities of the individual from trespass by foreign groups and from individuals or groups of individuals within the society. All functions of government are directed by persons selected through orderly processes by the citizens from among citizens. Each one has the responsibility of making judgments regarding the purposes and programs of the state. According to his wishes and abilities he can accept further responsibilities in the activities of the state as a citizen advocate for certain public policies, as a worker or official in political parties or other groups, or as an official of the state if chosen by processes provided for by law.

The essential features of the democratic state grow out of its responsibility for the protection of the opportunities of the individual and its responsiveness to change through orderly, evolutionary processes. Few, if any, particular forms, legislative, administrative or judicial, are characteristic of, or necessary for, democracy. In order to remain consistent with its objective, laws, forms and institutions often need to change. For example, in one age greater individual freedom of action for business may lead toward this objective, whereas, in another age, greater regulation of business may be required to reach the same objective. The opponents of democracy may even insist upon the maintenance of outworn forms in the name of service to democracy, but actually to prevent the attainment of its essential objectives.

The essential features of the totalitarian state grow out of the identification of the interests of a minority with the welfare of the state. The minority may sincerely believe that their program is in the interest of the state. A majority of the citizens may or may not approve this

program, either all or part of the time, but they are not required, or even expected, to assume responsibility for judgments, except in fields assigned to them. Their acquiescence is required, with or without agreement. One great advantage of living in the totalitarian state is that the citizen doesn't need to take responsibility. He doesn't need to study and think about what he should do in the public interest or, say, for whom he should vote. Such a luxury can not be tolerated in the democratic state.

The particular form of the state is not of vital importance. There are many ways by which the minority may gain power, even within the framework of a weakening democracy. Oftentimes, they have first gained a plurality during a period of confusion, when other groups have had no appealing programs. Once the minority has entrenched itself, the ideas of others are excluded, first through rigid controls within its own bureaucracy and later throughout the state.

An initial program is announced vaguely in terms of a slogan or set of slogans. The original idea, that grows into the total idea, is also unimportant to the end result, so long as it gains wide acceptance at first. Any single idea, however good, can become a banner of exploitation, when interpreted to exclude other ideas and other moral values. Emphasis is placed less upon the idea than upon its totality. The partial believer is more dangerous, more to be fought down, than the total disbeliever. The end result is a loss of freedom for the majority, suppression of new ideas, wars with other states and revolution within the state.

In both kinds of states, schools, trade and professional organizations, youth groups and all other activities usually emphasize the same general principles, although there are exceptions. In the democratic state, for example, groups may push their own interests so vigor-

ously as to deny, or attempt to deny, freedom of action for others in some fields. It is even not uncommon to find various kinds of groups with rigid bureaucratic systems like those of the totalitarian state. In a healthy democracy such organizations defeat their own purposes in time, however, from want of general support. But bigness in corporations or other rigidly organized groups is usually suspect in democratic states. The leaders of the totalitarian state may grant certain of the privileges and responsibilities of a democratic society to members within the bureaucracy, and even to the social group as a whole in restricted areas, especially as they feel confidence in their positions of power.

The larger the number of persons whose judgments are involved in the formulation of policy, the longer the time required before action can follow. Thus in times of crisis, when action must follow action speedily for success, the ordinary processes of formulating policy through discussion among citizens is suspended in a democratic state. Even the elected representatives may voluntarily delegate many of their normal functions to a small group or to an executive. It is said that the democracy becomes totalitarian for a brief period. This is scarcely correct. There may be dangers. During a crisis there are always dangers, by definition. But what happens in such a circumstance is that the social group recognizes, democratically, a crisis, and for its duration directs the attention of public officials toward those objectives essential to the continuity of the state, rather than toward many objectives and the more gradual perfection and adjustments of matters less immediately pressing for solution.

A willingness on the part of citizens—farmers, scientists, industrial workers or any others—to turn their problems over lightly to a special group or bureaucracy, except in times of crises, rather than take

responsibility for thought and action themselves, is a grave danger signal in a democratic state. The organization of undemocratic pressure groups, unable or unwilling to cooperate with others in the general interest, leads to a type of confusion that paralyzes the democratic processes of government. By devious means the bureaucracies of such groups may perpetuate themselves, even when their membership as a whole is willing to make those compromises which are the very essence of democratic adjustment.

Many have seen these bureaucratic groups lead to the collapse of democratic government. They fear that the suspension of certain democratic procedures during crises may lead to the danger that the bureaucracy to whom power has been intrusted will become the basis for a totalitarian ruling minority if determined and strong, or will be replaced by such a minority if weak and hesitating. The extent of this danger depends less upon the measures taken during the crisis than upon the extent to which the democracy had maintained its essential goals previous to the crisis. Although the delegation of power is a hazard in times of peace, it may be essential in times of crises. If the social group, the state, has failed to provide opportunities for large masses of its citizens and these have no "stake" in the outcome of the crisis, have nothing to lose and little to hope for, the danger is great, quite regardless of specific measures taken when the crisis comes. And one will come under such circumstances, from within if not from without. A democracy can only protect itself during crises by continual adjustment and planning consistent with its goals during periods of comparative calm, while there is time.

THE CULTS OF SCIENCE

Through all the praising of science and all the criticism, it is well to remember that scientists are men, not greatly unlike other men. Some are pro-

ficient; others are indolent and lazy. Some are earnest and sincere; others are bluffers. Some are narrow and bigoted; others have a broad and tolerant understanding. All profess to be seeking the truth—the truth that sets men free—but instead, a few seek to mystify and to confuse. Essentially the same may be said of any other group. Scientists are due respect and owe responsibilities, like others, according to their abilities and contributions to society.

Perhaps we may say that the chief function of science, in the social world at least, is to make predictions, and make them quantitatively. The eternal question is less "why" than "how much." The "why" of any action, when known, becomes "how," and from these "hows" scientific principles are developed. On the one hand, we may conceive of the scientist who is concerned primarily with the basic principles of science growing out of the relationships of facts to facts. Then there is the applied scientist, or artist-scientist, who is concerned with the application of these principles in the social world, the relationships of facts to men. These are not mutually exclusive by any means, for most fundamental researches are suggested by problems in the applied fields, and many unforeseen applications grew out of fundamental research. Then, too, most scientists are concerned, to some extent at least, with both. But mere measurement, without regard to the relevancy of the facts, is scarcely science, even though scientific equipment and jargon may be employed. Unfortunately, there are some so-called scientists who are concerned, neither with the fundamental laws nor their application. The former requires tasks beyond their strength and the latter is beneath their academic dignity. Perhaps they are the "pure" scientists!¹

¹ The author intends no criticism of that pure science which is fundamental science. He dislikes the expression "pure science" because of what hides under its cloak that is not fundamental science.

There is too much overlapping to classify scientific activities into a neat system. Yet the rough grouping of these activities into geology, physics, botany, chemistry, sociology and so on has some convenience if not taken too seriously, and especially if not allowed to confine the investigator unduly or cause him to oversimplify his problem. Botany, for example, includes some physiology, physiology includes some botany and zoology, and all three are included in biology. Biological chemistry or biochemistry make a bridge to chemistry but include a lot of physical chemistry which is itself a sort of bridge between chemistry and physics requiring a good foundation in mathematics.

Any one of these names refers only roughly to an approximate area within the total, and each overlaps with several others. Some like analytical chemistry or mineralogy, are much more specific than others, like ecology or geography that deal largely with relationships. An extreme specialization in one small area, as some physicists or biologists have done, leads to isolation and to failure because of an inadequate understanding of relationships essential to progress. An extreme spreading of effort, as some sociologists and geographers have done, leads to superficiality and to failure because of an inadequate understanding of fundamental principles and facts.

Perhaps the greatest harm of these systems arises from the unhealthy desire of many specialists to be recognized prominently in the system. For example, with the torrents of words sociologists have written to prove they are scientists—to establish a satisfying nomenclature—much grist might have been ground. But nomenclature alone doesn't get results. There always will be rivalry between the several groups: the specialists will parade their data in terms of an impressive jargon and the generalists will make their sweeping pronounce-

ments with the latest clichés. A number will maintain their balance. It is upon these that responsibility for work and progress and usefulness in a democracy depends.

Scientific activities may be grouped into other kinds of overlapping categories. A grouping into fundamental and applied science has already been mentioned. Of course, these are not mutually exclusive either. Fundamental research in plant physiology, for example, may include a good deal of applied chemistry. Researches directed toward the solution of practical problems in soil management may lead to the discovery or perfection of fundamental principles in soil science.

Then the individual areas of science are sometimes grouped loosely into physical, biological and social sciences, or simply into natural and social sciences. Many areas have been staked out during recent years and given new names, like cultural anthropology and rural sociology. People are still arguing over whether these and even some of the older fields like economics and political science are really sciences. Certainly much that passes under these names isn't scientific, but the argument is unimportant, in the abstract. What really counts is whether, in individual cases, the investigator has used the scientific method and subjected his results to the objective tests of scientific criticism. The confident arrogance of a few self-appointed generalists in the social sciences, who proudly claim attention because they are not biased by deep understanding in any narrower field, should not lead one to condemn all those in the field. It is almost axiomatic that, when a person condemns any field of knowledge, the only thing disclosed is the speaker's ignorance of the field.

Realizing fully the same kind of overlapping, it is also convenient to think of scientific activities under three heads as (1) description and discovery, (2) in-

vention or development of new things or systems and (3) planning or synthesis of scientific facts and principles with human values in the social world.

In our culture, early emphasis was upon scientific activities belonging within the first group, then later, especially during the past hundred years, emphasis was divided between the first two, and only recently are scientific principles and techniques beginning to be used in social planning to an important extent. They will be used. About that there can be no question. The question is rather by whom and with what consideration to other principles. In the successful totalitarian state scientific principles are coordinated quietly with the aims of the minority in power, while in the successful democracy they are coordinated with the values and aspirations of the majority through free discussion and debate.

So far, there has been a serious lag. It is a commonplace to note that scientists in general, and physical scientists in particular, have been more concerned with the minutiae of their principles and their application to individual problems than with the relationship of science to society. Recently there has been a spirit of neo-classicism in each science whose devotees are more concerned with the outlining of "fields" and the definition of concepts than with the content of the concepts. Frequently, of course, some scientists take a long jump over the sinful world of to-day to deal with cosmic relationships, speculative relationships of great breadth. Not many come to grips with the here-now job of the social group and of governments to try, somehow, to keep things going, to harmonize our industry, our agriculture, our exchange systems, our transportation machinery, our communications, our concepts of private property—in short, the whole collection of thoughts and things,

work and play, and fads and fancies that make up our civilization.

Perhaps they have done as well as most other groups, say the executives of business, for example; perhaps less well than the artists. Yet one has a right to expect more of scientists: their job is to study relationships and make predictions. Certainly no group has more at stake in democracy, personally, selfishly, than scientists. An authoritarian system of social or institutional organization holding to the *status quo* in any field is bound, sooner or later, to clap the scientist in jail, or worse, if he remains a scientist in fact. Suppression of truth—in new discoveries and new principles—in one field must eventually lead to suppression in all fields, since knowledge is, after all, one whole. Naturally, new ideas in economics or sociology are more immediately suppressed by dictators or other persons of privilege than new ideas in glacial geology or plant physiology. But recent experience has shown that within a short time even the physical scientist finds he must conform to the official "line." All sciences must have an official line in the totalitarian state.

The need for coordination, planning, arriving at proper relative emphasis, or whatever one chooses to call it, has been recognized vaguely. Partly at least, in response to this need many of the new sciences, so-called, have arisen, like rural sociology, business administration, and many more that are to coordinate many specialties. Thousands of speeches are being made about it. No one seems to be strongly against it, in general. Then why don't we have coordination? Partly, perhaps, because coordinators, as over-all putters-together of many principles, are born, not made, certainly not made with a few easy lessons. Even where they do exist, over-all coordinators can only work effectively in totalitarian states or in organizations that have their essential characteristics.

The democratic process of achieving coordination does not depend upon super-coordinators or administrative generalists, but upon many coordinators; that is, each is a coordinator who has something to contribute and takes responsibility for doing so. This principle is as important to the healthy life of a public or private managing bureaucracy as to the democratic state as a whole. The first step in the process is a common understanding of the problem. Within this framework, each may see where his contribution belongs, and through discussion and compromise with others of similar competence, arrive at more general principles. Scientists have been unwilling to assume their share of responsibility, which has

(To be concluded)

become very great, regarding how their data and principles are used, both outside and inside the government. Many have lacked the courage to speak out as their reasoning dictates. They have seen their data twisted and turned to justify all sorts of "programs," "gadgets" and "cures." Many have become disgusted with the popularizers of science, with the generalists whose lack of understanding leaves them "unprejudiced." But by receding into ivory towers of special cults and of academic isolation they leave vacant a gap they should fill, not in the rôle of a new aristocracy, but as an essential part of democratic government in the modern world, and do so while there is time.

PARASITISM IN RELATION TO THE LIVESTOCK INDUSTRY OF THE SOUTH

By Dr. BENJAMIN SCHWARTZ

CHIEF, ZOOLOGICAL DIVISION, BUREAU OF ANIMAL INDUSTRY, U. S. DEPARTMENT OF AGRICULTURE

INTRODUCTION

UNLIKE the virus and bacterial diseases, that break out with almost explosive violence and spread rapidly among flocks and herds, leaving many deaths in their wake, the parasitic diseases of livestock, more particularly those caused by helminths, tend to be chronic, as a rule, and may take a heavy toll from the resources of farmers and stockmen in the form of stunting, unthriftiness and death, before their presence is even suspected. It is not surprising, therefore, that in the past the major emphasis in this nation's struggle against livestock maladies was placed on the diseases of bacterial and virus origin. With victories against some of the most important of these livestock enemies already won, and others definitely in sight, it is to be

expected that in the future considerable attention will be focused on the more insidious but less sensational parasitic diseases.

The gradual eradication or control of one infectious livestock disease after another has resulted in a marked improvement of livestock and, undoubtedly, has been one of the most potent factors in the development of the American livestock industry. As this industry has grown in stature, it has assumed an increasing economic importance, with the result that livestock producers are becoming increasingly concerned over all the factors that hamper successful husbandry. That parasitism is a limiting factor in livestock production is recognized wherever domestic animals constitute an economic asset of some impor-

tance. In countries in which stock and poultry raising are major activities, the economic importance of parasitism bears a more or less direct relation to the economic importance of livestock. In short, the more valuable the livestock industry becomes, the greater is the stake which parasitic depredation entails.

IMPORTANCE OF LIVESTOCK INDUSTRY
IN THE SOUTH

In most of the South, including five South Atlantic states, namely, Virginia, North Carolina, South Carolina, Georgia and Florida, and the eight South Central states, namely, Kentucky, Tennessee, Alabama, Mississippi, Arkansas, Louisiana, Oklahoma and Texas, the development of the livestock industry was hampered for a long time by the presence of the cattle fever tick, the vector of tick fever or bovine piroplasmiasis. The prevalence in the South of this disease, to which the native cattle were immune because of exposure to infected ticks, precluded to a large extent the introduction of purebred sires and improved and purebred cattle, generally, from tick-free areas, because of the marked susceptibility of these hosts to tick fever. With the gradual release from tick fever quarantine of all the southern states, excepting two counties of Florida and a very narrow strip of Texas, along the Mexican border, the livestock industry of the South, as a whole, and not merely the beef cattle and dairy cattle sections thereof, has been assuming an increasing importance, with the result that, at the present time, livestock looms up as a highly important agricultural asset in this region, as the following considerations will show:

Based on recent statistical information released by the Agricultural Marketing Service of the U. S. Department of Agriculture,¹ there were present in 1940 in

¹ "Livestock on Farms," January 1, Release, U. S. Department of Agriculture, February 17, 1941.

the 13 southern states named, 20 per cent. of the nation's 10,602,000 horses and colts; 80 per cent. of the 4,309,000 mules and mule colts; 29 per cent. of the 68,801,000 cattle and calves of all kinds; 24 per cent. of the 54,549,000 sheep and lambs; 26 per cent. of the 60,207,000 hogs and pigs; 29 per cent. of the 429,042,000 chickens; and 26 per cent. of the 8,567,000 turkeys. According to the source of information previously cited, the 1940 aggregate value of this nation's livestock on farms, including poultry but exclusive of goats, was \$5,198,989,000, of which \$1,360,486,000 was represented by livestock and poultry on farms in the South. In other words, of the total national value of all farm animals and poultry, for the year 1940, 26 per cent. was on farms in the 13 southern states. The monetary value of the available livestock in the South on January 1, 1940, was more than twice that of its entire cotton crop for that year, including lint and seed, and exceeded by about \$175,000,000 the aggregate value of all the cotton lint, cotton seed, tobacco, wheat, cane for sugar and seed, cane syrup, potatoes, sweet potatoes, pecans, citrus, apples, pears, peaches, grapes and all truck crops raised in the South during 1940, according to the value of these crops as determined recently by the U. S. Department of Agriculture.² Of the remaining principal crops raised in the South, many, including corn, oats, barley, rye and other grazing crops, are raised principally for livestock feeds and are, therefore, definitely tied up with livestock production. Of the \$2,055,019,000, representing the cash farm income for the calendar year 1940 in the 13 southern states named, that derived from livestock and livestock products amounted to \$741,469,000 (36 per cent.) and exceeded by about \$150,000,000 the cash income

² "Season Average Prices and Value of Production, Principal Crops 1939 and 1940 by States," U. S. Department of Agriculture, December 18, 1940.

from cotton lint and cotton seed combined, based on data given in a recent release of the Bureau of Agricultural Economics.³

It is quite evident, therefore, in the light of the foregoing considerations, that the South is definitely in the livestock business and that a very large portion of its agricultural industry relates directly and indirectly to livestock production.

FACTORS FAVORING LIVESTOCK PARASITES IN THE SOUTH

Although livestock parasites are not peculiar to the South and, in fact, constitute a problem of national rather than regional importance, the climate and other physical factors of the southern environment are particularly favorable to the propagation of parasites. Among the parasitic species that are most injurious to livestock, many have free-living phases and others require invertebrate, intermediate hosts. The free-living stages of parasitic nematodes, in particular, thrive best in a mild, more or less moist climate, and those parasites requiring intermediate hosts, such as annelids, mollusks and arthropods, have, on the whole, better opportunities for completing their life cycles on a large scale in regions having a short, cold season, than in those having long, rigorous winters. In short, the mild climate, abundance of moisture and long growing season of the South, factors that are favorable to abundant pasture crops for livestock are favorable at the same time to a thriving parasitism. The association of gross parasitism with the tropical and subtropical regions of the world, based largely on the results of surveys to determine the incidence and intensity of human parasitic infections, has a greater basis in truth than in poetry, even when

³ "Cash Farm Income and Government Payments in 1940 are Estimated at \$9,120,000,000," U. S. Department of Agriculture, February 19, 1941.

applied to livestock parasites. As will be shown in the discussion that follows, there are, moreover, a number of pathogenic parasites that are either more or less peculiar to livestock in the South or more abundant there than in other sections of the United States. The entire livestock parasite picture, in so far as it can be viewed in the light of the rather meager knowledge that has been accumulated so far, blends a little better with the background of the South than with that of other sections of this country.

ECONOMICALLY IMPORTANT PARASITES OF LIVESTOCK IN THE SOUTH

Since the species of farm animals are the same the world over, it is not surprising that the parasitic fauna of these hosts is also essentially the same, regardless of where the farm animals are located. However, parasitic species having a more or less sharp geographical distribution are encountered here and there, most cases of this sort involving arthropod, molluscan or other intermediate hosts, present in one region and scarce or absent in another. Examples of localized distribution of parasites are the common liver flukes (*Fasciola hepatica*), which are abundant in ruminants in the Pacific Coast states, Rocky Mountain states, and parts of the South, and which have a spotty and, apparently, sharply limited distribution in ruminants in some of the North Central states, and are scarce or absent in these hosts in other parts of this country. Another parasite, the fringed tapeworm of sheep (*Thysanosoma actinioides*) occurs in the West but, so far as known, not elsewhere in this country. One species of ruminant stomach worm (*Haemonchus similis*) is known only from the South and Manson's eyeworm of chickens (*Oxyspirura mansoni*) is known only from Florida and Louisiana. In other cases the distribution of parasites in livestock in various places is conditioned, to a greater

or lesser extent, by temperature and moisture, this being especially true as regards some of the pathogenic nematodes that require no intermediate hosts but live for a time in the open. Thus, whereas the common stomach worm and intestinal trichostrongyles generally, that parasitize ruminants, occur in nearly all parts of the United States, being more abundant in some places than in others, hookworms and nodular worms of cattle, sheep and goats, are more important in the eastern half of this country than in the western half, the pests in question being especially troublesome in the South. In swine, the common nodular worms (*Oesophagostomum dentatum*) have a wide distribution, whereas three other species of porcine nodular worms (*O. longicaudum*, *O. brevicaudum* and *O. georgianum*) occur or are abundant only in the South. The swine kidney worm (*Stephanurus dentatus*) is a parasite of great economic importance to the swine industry of the South and of very little or no importance elsewhere in this country. The kidney worm is, in fact, a parasite of swine in tropical and subtropical regions. It is not known from Europe, except southern Spain, but is widely prevalent in swine in warm climates, including our southern states, its distribution along the eastern border seldom extending north of Maryland. The habits, especially the lack of resistance to cold, of the free-living stages of kidney worms, readily explain the distribution of these parasites. The eggs of kidney worms, in common with those of hookworms and nodular worms, to cite only a few examples among the pathogenic strongyles, develop and hatch rapidly in a warm, more or less moist climate; the larvae undergo their transformations quite rapidly under these conditions, attaining the infective stage in a few days. The films of moisture on the grass and other forage provide the essential conditions for the upward

migration of the larvae, which migration, in turn, is stimulated by the favorable temperature. The net result is the invasion of forage by the larvae, this placing the latter in a position favorable to their being swallowed by susceptible grazing animals. Barring the special cases noted, and several others not mentioned, the parasites encountered in livestock in the South are found also in most other parts of the United States.

In horses and mules, stomach worms, ascarids, large and small strongyles and pinworms are among the most debilitating of the internal parasites in the South, as they are also in other parts of this country and, for that matter, almost the world over. In addition to the parasites previously named, cattle, sheep and goats in the South are deleteriously affected by stomach worms of all kinds, intestinal trichostrongyles, lungworms and whipworms, these or most of them being also the most injurious internal parasites of ruminants in other parts of this country. Swine, in the South, as elsewhere, harbor pathogenic parasites such as stomach worms, ascarids, thornyheads and other species, the kidney worms and nodular worms previously mentioned being the outstanding species more or less peculiar to the South. Poultry parasites in the South are, in general, of the same species as those encountered elsewhere in this country.

Despite the specific identity of most species of parasites of farm animals in all parts of this country, the southern environment, as previously noted, provides more favorable conditions, during a greater part of the year, than that of other parts of the United States, for the onward march of most of the injurious parasites, more particularly those that have parasitic stages alternating with free-living, immature stages. Excepting only the larvae of large and small strongyles of equines, that have a marked resistance to inhospitable environmental

factors, such as low temperatures and lack of moisture, those of species of strongyles and trichostrongyles that parasitize food animals thrive best where the weather is mild and moisture is abundant. All the available evidence leads, therefore, to the inescapable conclusion that in the South, and especially in the lower tier of southern States, potential, if not actual parasitism can, and in some cases already has, become an economic problem of greater magnitude than elsewhere in the United States.

THE RELATION OF PARASITES TO THE AVERAGE LOWER VALUE OF SOUTHERN LIVESTOCK

Based on the statistical information previously given, 20 per cent. of the nation's horses present in the South on January 1, 1940, had a monetary value of only 18 per cent. of the aggregate value of these animals in the entire country. In the case of cattle, the discrepancy between the percentage of animals in the South and their relative monetary value, was even greater, the relation being 29 per cent. in numbers and 20 per cent. in value. The corresponding percentages for sheep were 24 per cent. and 20 per cent.; for swine 26 per cent. and 19 per cent.; for chickens 29 per cent. and 25 per cent.; and for turkeys 26 per cent. and 21 per cent. Only in the case of mules were these percentage relationships reversed, the 80 per cent. of the nation's mules in the South representing 84 per cent. of the aggregate value of all mules in this country. This is not surprising, considering the fact that in the South the mule has not as yet been replaced by mechanical power to the extent in which such replacement has occurred elsewhere in this country. Evidently the South is using mules for power on the farm and is selecting good stock for this purpose.

Among the factors that are responsible for the lower value of the South's meat

food animals, including poultry, poor breeding, inadequate feeding, mineral and other deficiencies, and parasites in excess of those harbored by livestock elsewhere in the United States, deserve primary consideration. In the light of available knowledge, it is difficult to determine the relative damaging effect of each of these and, possibly, other factors that operate to lower the value of livestock in the South. The possible interrelation between the factors named has not been even superficially explored, as yet, and no one is in a position at the present time to even venture a definite opinion as to whether such interrelationship really exists. That the excess parasite burden of livestock is partly responsible, in some cases at least, for the lower livestock values in the South is evident from the following considerations:

Early in 1937 the Bureau of Animal Industry investigated the causes of the price differential between hogs sold in southern Georgia and those sold in Chicago and determined that, in addition to the lower value of southern Georgia pigs resulting from a deficiency in yield and softness of the meat of peanut-fed hogs, parasitic infection accounted for part (about 16 per cent.) of the price differential, the estimated loss from such parasitic infection amounting to from 25 cents to 50 cents per hundred pounds of live weight, based on the then current hog prices. During the month of January, 1937, 425 out of 50,000 hogs slaughtered in one plant in southern Georgia were condemned entirely. Of those so condemned, 245 (57.64 per cent.) were considered unfit for human food because of parasitic infection, due largely to kidney worms and associated lesions. In addition, approximately 95 per cent. of the livers and practically all the kidneys of the 50,000 hogs under discussion, were condemned as unfit for food because of infection with kidney worms. An average of one pound or more of perirenal

fat had to be trimmed from each hog because of the presence in this tissue of this parasite. The total loss involved in all these condemnations, including trimming of the loins into which kidney worms had penetrated, amounted to approximately \$18,275, this giving a loss per hog of approximately 37 cents.

It is significant that this appreciable loss was due, in the main, to only one out of a dozen or so common parasites of swine. That the loss involved could be appraised financially was due to the fact that the records were made available through the cooperation of the meat packing establishment where the hogs had been slaughtered. The parasite losses of all kinds sustained on the farm as a result of stunting, unthriftiness and deaths, spread out so that they excite no undue alarm, can not be readily measured. That these immeasurable losses are as great as, if not actually greater than, those that have been ascertained in packing plants in special cases, is well known to workers the world over who are familiar with gross parasitism and its effects on meat food and other farm animals.

HOST-PARASITE RELATIONSHIP

Some persons, impressed with the relative size of worms and their abundance in animals, ascribe most or all unthriftiness in farm animals to these parasites, whereas others, adopting an equally extreme view, disregard altogether parasitism as a factor in livestock production. Those who subscribe to the former view assume that the failure of domestic animals to grow normally is due almost exclusively to the inroads of parasites, an assumption that is warranted only if other factors, especially breeding, feeding and mineral deficiencies, can be eliminated as possible complications. Gross parasitism produces a symptom-complex resembling that of malnutrition in general, but not all cases of malnutrition are

parasitic in origin. The view that parasites have little or nothing to do with unthriftiness is as unsound as the opposite view, and is based, as a rule, on deductions from unsound premises. The failure to find gross or more or less marked parasitic infection in cattle, sheep, swine and poultry that have been slaughtered for food is not good evidence that such infection did not exist in these animals before they reached market size. Like other living things, parasites go through, rather rapidly, periods of youth, maturity, during which they reproduce at almost unbelievable rates, and finally drift into a stage of senescence with its inevitable consequence of death and elimination from the host. Moreover, the evidence that has accumulated during the past few decades shows that immunological phenomena enter into the host-parasite picture, and that, in time, hosts become not only refractory to parasitic infection, but actually lose, in some cases, their parasite load, when the host's resistance gains the ascendancy over its susceptibility. In short, while the slaughter house is a happy hunting ground for the parasitologist in need of material for class use or research, it has only limited value in actually affording information on the wide prevalence of parasitism in farm animals. That some information concerning the prevalence of parasites is obtainable in abattoirs, more particularly as regards species that leave an indelible impression on the host in the form of macroscopic lesions, such as those produced by kidney worms in swine, nodular worms in sheep and liver flukes in cattle, is self-evident. However, the essential facts concerning parasitism in livestock can be ascertained best by investigations on the farm, or under farm conditions, designed to disclose the rate of acquisition of parasites and the changing parasitic fauna, especially in young stock, in association with morbidity and mortality.

METHODS OF CONTROL

The two principal weapons that have been used with success in controlling livestock parasites are chemotherapy and sanitation. The former is designed principally to cope with parasites already well established in their hosts and is largely curative. The latter has as its object the prevention of gross parasitic infection and is, therefore, prophylactic. The prophylactic use of drugs as a means of controlling livestock parasites has given good results in special cases.

In general, the application of existing information to the prevention of parasitic infection has lagged far behind the available knowledge on this subject. Livestock producers appear to be more inclined to spend money for cures than to exert efforts in the direction of dispensing with the need of cures. Evidently, the assumed magic of drugs has a stronger appeal than the prosaic tasks incident to prevention. Treatment of parasitized animals and, in some cases, periodic prophylactic medication have their place in a sound program of livestock sanitation. The use of drugs possessing little or doubtful curative value is all too common, however, to be disregarded, and should be combatted vigorously in the interest of the welfare of livestock producers. It must be remem-

bered that few, if any, diseases of man or livestock have been eradicated or even successfully controlled by chemotherapy. The value of prophylaxis, on the other hand, has been vindicated time after time as the truly magic weapon for coping with many serious diseases of man and farm animals.

Prevention of parasitic infections must be based on sound knowledge of life histories and modes of dissemination of the causative agents. Such knowledge is accumulated slowly by observation and experimentation, the facts ascertained constituting the only firm foundation on which control measures can be successfully planned. The present state of this knowledge is comparable to a structure of which only the masonry has been put up, with work on the interior only just begun. Pasture rotation, rotation of stock, use of temporary pastures whenever possible, sanitation of animal shelters, special care of young stock and similar prophylactic measures represent only the walls of a sanitary structure, the completion of which will require the efforts of many skilled scientific artisans, versed in the technique of research and possessed of a view-point that discovers in the raw data of science practical applications that can be utilized in erecting barriers to impede the unrelenting push of parasitism.

MODERN INSTRUMENTS AND CONTROLS

By DOUGLAS M. CONSIDINE

CHEMICAL ENGINEER, PHILADELPHIA, PA.

I

Industrial instruments and automatic controls present a perplexing picture to many of us. Although we may be cognizant of many startling applications of instruments and controls, we may be unaware of their less impressive, but tremendously more important uses. The "mechanical man" conception of automatism, often popularized at past exhibitions and fairs, is essentially devoid of truth. Presentation of automatons in detail, even as to the shape of man, suggested that instruments and controls simply substitute the hands and brains of man. This conception belittles both man and instruments, as for innumerable applications one is beyond substitution by the other.

Industrial use of instruments and controls is so essential to many applications that a breakdown in the control system results in complete stoppage of the manufacturing process. During the present crisis, instruments and controls are playing a silent, but salient role in keeping our factories, ships and aircraft in constant operation. In modern manufacturing operations, many variables are encountered which must be measured and controlled, such as temperature, pressure, flow and chemical composition. For instance, temperature is only one variable which must be controlled to produce a sheet of paper with consistent quality and properties. In so many industrial applications, the final result does not depend upon control of one variable, but upon control of many.

Instruments and automatic controls have progressed to their present stage of development in three distinct steps. First, it was desired to measure the conditions under which various operations

proceeded to a satisfactory conclusion. Indicating thermometers, pressure gauges, speedometers and flow meters were developed to tell just what changes were taking place. Later, it was desired to record the changing conditions. Recording instruments were developed and were found to be of inestimable value in analyzing a process, comparing it from shift to shift and from day to day. Finally, automatic controlling instruments were developed not only to measure the variable quantity and record its magnitude, but actually to maintain the variable within very definite limits by purely automatic means. To-day, all three forms of instruments, indicating, recording and controlling, are playing an indispensable role in our daily life.

II

Instrumentation has developed hand in hand with continuous processing so vital to the petroleum and chemical industries. Development of new instruments has encouraged the use of continuous processing. Conversely, increasing efficiencies possible with continuous processing have resulted in demands on the instrument manufacturers for new control devices.

The petroleum industry is outstanding for its magnanimity of continuous processing operations and for its use of automatic controls. Fifteen years ago, nearly all refinery operations were conducted on the batch basis in which relatively small quantities of substances were refined at one time. Such operations may have required but a few hours, or possibly several days for completion. Regardless of the time involved, upon completion of the refining operation, the final products and by-products were discharged, the equipment involved shut

down, inspected, cleaned and recharged with the process raw materials. In many cases, long periods of waiting were necessary while the apparatus cooled to a tolerable working temperature. The time between discharging and recharging such equipment represented a complete loss. It was necessary to employ several duplicates of such equipment to give a refinery an overall continuous production. Savings of time and labor accomplished by present continuous processing are responsible to a great degree for the reduction in gasoline and oil prices effected during the past decade.

Cracking or thermal decomposition of oil is of major importance to the petroleum industry and to all consumers of petroleum products. By cracking methods, the yield from crude petroleum of fuel for use in internal combustion engines, automotive and aircraft, has been increased by over 30 per cent. Cracking processes now are carried out in units with capacities as great as 30,000 barrels per day, as compared with units of 125 barrel capacities two decades ago. In the pioneering days of cracking, small units were designed and operated in batteries. Frequent shutdowns of individual units were expected and provision was made for such eventualities. Modern refineries carry out their cracking operations with two or three single units having capacities equal to entire batteries of former units. With such large units, shutting down involves great expense and hazards. Use of automatic devices and centralized control has enabled such processes to continue in operation for months at a time in complete absence of shutdown hazards.

III

Instruments make up the nervous system of the modern air transport. Together with radio, instruments have made air transportation an exact science. To-day, the airliner travels over an invisible radio highway; the pilot keeps the plane on its true course without

making visual reference to ground objects.

Modern passenger aircraft instruments may be segregated into three general classifications, namely, (1) navigation, (2) engine and (3) radio instruments. The pilot acquires information concerning engine conditions from a set of instruments located on the main instrument panel. In a twin-motor plane, there is a set of instruments for each engine. Radio instruments aboard vary with the extent of radio facilities provided by the airline. Unfortunately, the invisible radio highways made possible by coordination of instruments with radio do not form a complete network over our commercial airways. The trend is to flying along the radio beam and, with developments as planned, our airlines will continually avail themselves of the latest advances in instrument flying. Although there are nearly three dozen instruments on the panel board, it is difficult to distinguish their relative importance; all convey vital information to the pilot.

An artificial horizon indicator enables the pilot to keep the plane perfectly level. An altimeter indicates the height of the plane above sea-level. From his knowledge of the terrain below and a knowledge of the barometric pressure, as received over the plane's radio, the pilot can make adjustments so that when landing the altimeter will indicate the exact altitude of the plane with reference to the landing field below. Two altimeters on the instrument board check against each other and ensure this information in case of one instrument failure. Two instruments provide the air speed, from which the pilot can adjust the plane's speed to conform with predetermined schedules. A rate-of-climb indicator denotes the plane's rate of vertical ascension or descension.

Individual instruments for each engine indicate the engine speeds, fuel, oil and manifold pressures, all important considerations for proper engine opera-

tion. Two instruments indicate the temperature of the hottest cylinder on each engine, a most important consideration, since airplane engines do not operate satisfactorily or economically above a given temperature. A gauge indicates the volume of gasoline fuel in each of four fuel tanks. Still another instrument indicates the temperature of the outside air, important for making proper adjustments pertaining to the performance of the plane. All these instruments are concerned with the manual operation of the plane.

A "gyro" or automatic pilot assists the pilot in performing the routine duties of flying and may be cut in or out instantly at the will of the pilot. While in operation, the gyro pilot actually flies the plane, keeping it perfectly oriented about all three axes. When the gyro pilot is in operation, the pilot performs a left bank turn merely by turning a knob instead of manually adjusting the rudder and ailerons. Whenever cruising conditions are normal, the gyro pilot is used, enabling the pilot to devote more time to other important duties concerned with radio communication and navigation calculations.

Radio not only serves as a means of communication between the plane, airport and weather stations, but also provides an invisible air highway between terminals. A radio beam provides the pathway and instruments aboard indicate the plane's position with reference to this path. United Air Lines Mainliners are equipped with four radio receivers and one transmitter. The four receivers are tuned to four different bands of radio wave frequencies. One receiver indicates the plane's left or right position with reference to the guiding radio beam extending from terminal to terminal. Another receiver automatically turns on a light when the plane has arrived at a given destination, or at the intersection of two radio highways. This receiver also turns on a light when the plane is approaching the

airport, lights another when the plane is passing over the edge of the airport and still another when the plane is directly over the airport. A third receiver is sensitive to waves emitted by regular radio transmitting stations. When the pilot tunes his receiver to one of these stations, an instrument automatically indicates the angle which the wave from this station is making with the plane's line of flight. Location of this station is ascertained from the call letters and by tuning the receiver to another station and ascertaining its angle, the pilot can calculate the exact location of the plane. A fourth receiver is used in connection with the plane's transmitter and serves as the line of communication between the plane and airports and weather stations.

As many as seven additional receivers and two additional transmitters are being considered for installation as standard equipment on the Mainliners. A new transmitter and receiver will provide absolute altitude readings above the terrain below. These will not be dependent upon sea-level and barometric pressure readings. The transmitter will emit a radio wave which will be reflected by the earth's surface and received by the plane's radio in an instant. A receiver now being developed will provide the pilot with an invisible glide path for making a complete radio landing. When this device is in use, the pilot will consult the glide path instrument when approaching the airport. The radio glide path instrument will indicate the plane's left-and-right and up-and-down position with reference to the glide path. By keeping the plane adjusted in accordance with this instrument, the pilot will bring it down to the field in a perfect landing without making visual reference to the airport. Such instruments are accurate to within much less than a foot in either direction. Wide use of these instruments is being made in Europe for landing giant bombers during adverse weather conditions.

IV

The steel industry has given increased attention to instrumentation during the past decade and, to-day, instruments and controls are playing a major role in the industry's production of higher quality steels at lower costs. The complete coordination effected by controls and the extreme flexibility of their application has resulted in faster mill operation and greater production. A modern steel mill represents a massive concentration of power. In a rolling mill, the total power of the main rolling drives may be as great as 30,000 horsepower. In many cases, this vast amount of energy is controlled by less than one-half dozen men. To utilize such an enormous amount of power safely and effectively, the operators controlling it must have a great number of facts available instantly at their finger tips. When it is realized that steel slabs and sheets pass along the production lines at speeds as great as 2,300 feet per minute, it need not be stressed that major operating adjustments must be made in advance. Only through instruments can such information be conveyed to the operators. Only through instruments can adjustments be made in time for safe and efficient operation.

Two instruments serve as primary guides in rolling mill operation, namely, a wattmeter which indicates the amount of power being consumed in the rolling stand and a tachometer which indicates the speed of the rolls. These instruments serve to proportion work from one rolling stand to another and to make speed adjustments in advance. Temperature is of primary import to steel production from the time ore is reduced in the blast furnace to the final fabrication into a finished product. With temperatures as high as 3,000 degrees involved, ordinary thermometers are useless. Fortunately, the science of pyrometry has evolved instruments which can measure temperatures of

objects without contacting them physically. Recent advances have made it possible to read the temperatures of molten steel in the open hearth furnace, of an ingot in the soaking pit and of a rapidly moving steel strip, as it passes at high speeds through the rolling mill. The temperature of this moving strip not only is indicated, but is recorded on a chart.

A knowledge and control of the temperature of steel as it is produced and processed is of utmost importance to the ultimate consumer. The proper grain structure and surface finish, so important to subsequent fabricating operations, are dependent upon the steel's temperature during the latter stages of the rolling operation. This is only one example of a variable which must be measured and controlled in order that steel will come up to specifications.

V

Air conditioning is a field which has received considerable attention during the past decade. Many of us fail to realize the extent to which successful air conditioning is dependent upon automatic controls. Industrial air conditioning, where exacting temperatures and humidities are maintained in manufacturing and storage buildings, is an integral requirement of many modern industries. Exemplary for their dependence upon humidity control are the tobacco, textile and paper industries. Controlling the percentage of water vapor in the air not only requires removal of moisture, but more often the addition of moisture. Many industrial processes and materials are sensitive to humidity and temperature changes impossible to comprehend without the aid of instruments. For example, a change of only 2 per cent. in relative humidity necessitates the adjustment of a cigar-making machine.

In air-conditioning installations of vast dimensions, large numbers of instruments and controlling devices are

required. Over sixty recording controllers are used to maintain the air temperature to within one half degree of the desired temperature in a large broadcasting company's studios and offices. In this million dollar system, twenty-three million cubic feet of air per hour are moved through the system, providing a change of air every eight minutes. Dependence of successful air conditioning upon accurate regulation of temperature and humidity has been a great incentive to the development of better instruments and controls. Conversely, the availability of fine instruments has fostered the great expansion of the air-conditioning industry.

VI

Modern power plants are responsible in no small degree to instruments and controls for their present admirable status. Production of steam in quantities of 700,000 pounds per hour, not uncommon in our large power plants, represents a vast undertaking and responsibility to the operating staff. As with continuous processing in the petroleum industry, instrumentation has encouraged power plants of increasing magnitude. With pressures as high as 1,400 pounds per square inch and temperatures as high as 800 degrees, the hazards are too great to allow the operating responsibility to rest solely upon a staff of skilled workers. Instruments and controls work all hours of the day and night, constantly checking upon the actions of the operating staff and ruling out mistakes.

One of the most important controls in boiler operation is the automatic feedwater regulator. As water is converted into steam, the water level in the boiler falls. The feedwater regulator automatically functions to supply fresh water as fast as steam is produced. In large boilers supplying as high as 60,000 pounds of steam per hour, it is possible to maintain the water level to within a

three and one half variation! Of course, responsibility for such accurate operation is not rested solely upon one instrument or control system. Several instruments stand by and give alarms, if the level falls below that predetermined for safe operation. An instrument which has enforced boiler room economy to a great degree is the carbon dioxide meter. The most economical burning of a fuel is obtained when the gases exhausted from the stack contain a definite percentage of carbon dioxide. Therefore, an instrument which is sensitive to the quantity of carbon dioxide present in the flue gases can convey this information to the operator, or in itself actuate controls which regulate the amount of air being forced into the combustion chamber. Nearly perfect combustion can be maintained by using a carbon dioxide meter for regulation of draft.

Like the production of steam at enormous pressures, the production of chemicals entails many hazards during the process of their preparation. The chemical industry is one of the better customers of the instrument manufacturer. A new two-million dollar synthetic phenol plant is exemplary of what modern instruments and chemical engineering design can accomplish. This plant has a production capacity of 15,000,000 pounds of phenol per year with impurities and by-products less than one tenth pound per pound of phenol, a phenomenal achievement in chemical manufacture. And yet this outstanding plant requires only seven men and one supervisor per shift for complete operation! This is an example where labor has not been replaced because of savings in wages and salaries, but because of the greater accuracy and responsibility obtained with automatic controls.

VII

Very few products reaching our homes have escaped passage through some

process environment controlled automatically. For instance, in a large dairy installation, over 40,000 pounds of milk are pasteurized per hour in an automatically controlled process. Milk is pumped into the pasteurizer between 40 and 50° F., brought to a temperature of 145°, held at that temperature for thirty minutes and then pumped through a cooler to a bottling machine. Automatic devices control the entire process and a recording thermometer charts a continuous record of the process temperature.

The industrial trend is toward coordinated process control, the latest development in control systems. Time is the governing factor in coordinated control. It is not enough to control a temperature within definite limits from hour to hour. Some processes require holding a temperature at 180° for thirty minutes, gradually raising that temperature to 200°, holding it at that point for two hours, and then lowering it to that of the atmosphere. Such a cycle may have to be repeated time after time. Simultaneously, a pressure may be involved which requires controlling in accordance with a fixed program. Master controllers coordinate any number of variables. Flow of fluids, pressures, temperatures, level of liquids, all may be controlled simultaneously by a master program controller. Thus, the variables are controlled in accordance with their variations as a group, as well as their variations as individuals.

Industry is giving increasing attention to telemetering, the science of transmitting information detected at one point to another point a distance away. Ordinarily, indicating and recording thermometers, pressure gauges and flow meters are installed within one hundred feet from the point where the actual measurement is being made. With the aid of telemetering, the variable may be measured and its magnitude recorded many miles away.

Included among the advantages claimed generally for automatic over manual means of control are the production of higher quality merchandise with a reduction of labor and other costs. Many substances are in commercial production to-day only because automatic controls have made the manufacturing process possible. Where production conditions are sustained within definite limits from hour to hour and from day to day, it is evident that the resulting products will be more consistent in quality. Savings of time and labor effected by controls allow more and better materials to become part of the finished product. It can not be denied that automatic control has added to the quality of many of our products. True, instruments and controls have displaced labor from the operation of many processes, but it must be emphasized that controls have made innumerable jobs possible. This is true not only in the manufacture and maintenance of instruments themselves, but in the creation of processes impossible to carry on by manual means of regulation alone.

Time saving accomplished by the use of controls is proved by an example from the tobacco industry. A previous process for humidifying tobacco required the tobacco to remain in a sweat room for a period of two weeks. With a new process, the same amount of moisture is added to the tobacco within a period of nineteen minutes. During that nineteen minute period, the automatic equipment operates forty valves from one to six times each, a task impossible manually from a practical viewpoint.

All of us are surrounded by instruments and controls. Usually their accomplishments are so subtle and reserved in action that we tend to assume their results as a matter of course. Were all industry suddenly to revert to manual means of control, the bottleneck so produced is beyond comprehension.

LANDED ESTATES AND PEASANT FARMERS IN HUNGARY

By Dr. GEORGE KISS
ANN ARBOR, MICHIGAN

THE present war in Europe is being fought on many fronts. Battles are waged on land, on the high seas and in the air. But perhaps for the first time in modern history, the most important engagements take place on fronts less spectacular than those appearing in newsreels and press reports. This new kind of battle is fought in the studies of ministers and diplomats and is fought on a double issue. While it is true that the major preoccupation of the negotiators is to recruit allies, to assure the supply of vital raw materials and to protect the great trade routes, an increasingly important part of these negotiations is devoted to future reorganization of Europe, to the peace that is to follow this conflict. It is in this connection that the present structure of European states is of supreme importance. A new and better organized world can not be built upon a combination of states separated by political, economic and social differences. These differences can and must be solved or any new order will have no better chance to survive than that created by the Paris settlement of 1919.

The social and economic organization of some states in Central and Southeastern Europe has frequently been termed as "feudal." Many writers have described the problem of great masses of landless peasants, exploited by a small class of omnipotent landlords. Few of these studies, however, have attempted to discover the origin of the problem, to analyze its factors or to present a logical solution. Hungary, among these states, has been characterized as the land of giant estates and of very small peasant

farms. The purpose of this study is to describe the formation of this social and economic system, to analyze present conditions and to attempt an outline of reforms that might improve the lot of millions of poor peasants.

I

Hungary occupies a central position in the Danube Basin. Many times it has played a decisive part in European history. Many influences have penetrated its land and people, many invasions have menaced its civilization and forced the inhabitants to rebuild time and again.

Medieval Hungarian society was based on the feudal system. The social unit was the village community. Early Hungarian agriculturists have doubtlessly been influenced by the social and economic systems prevalent at this period in neighboring countries. Of these, perhaps the Russian and the South Slav systems were the most important. The Russian "mir" was a village community, with common lands, directed by its elders. The South Slav "zadruga," on the other hand, was a house-community where several hundred people, kinsmen united in families, lived together. They have each exerted considerable influence on early Hungarian life. The pattern of land use in Hungary during the Middle Ages was probably midway between the Eastern and the more advanced Western European systems. The village community paid dues and taxes to the landlord and to the church. It cultivated its fields in the three-year crop-rotation system common to most of the lands west of the Carpathian Mountains.

This system, although allowing a certain freedom to the serfs, burdened them heavily with taxes and forced labor. The idea of peasant revolutions, of the French "Jacqueries" of the fourteenth century, of the Hussite movement in Bohemia and Moravia, during the fifteenth century, found ready followers on the Hungarian plains. The rising tide of small, local rebellions against overtaxation and oppression culminated in the first years of the sixteenth century. In 1514, an army of several hundred thousand Hungarian peasants, recruited for a Holy War against the Turks, refused to disband when the Crusade was postponed. They marched against their lords, massacring, looting, giving free outlet to all their age-old grievances. The peasant revolution was finally crushed after a severe struggle and its leaders executed. The consequences of this rebellion were fatal both to Hungarian peasantry and to the country. The Hungarian Parliament, in 1515, adopted a series of laws, creating more taxes, additional forced labor and binding the serf to the soil where he was born. Ten years later, when the country rose for a final struggle against the Turks, the peasants, a powerful military factor, were virtually prisoners in their fields. In the battle of Mohács, in 1526, Hungary lost its king, its freedom and its unity for 160 years.

The years following the Turkish victory were among the darkest in Hungarian history. The heart of the country was under Turkish rule. Its population deserted the open spaces and formed huge peasant towns, while fields, meadows and gardens were devastated by the invaders. When, at the end of the seventeenth century, Hungary was liberated and the Turks pushed back south of the Danube, ruined homes and deserted fields remained.

In the Austro-Hungarian monarchy of the eighteenth century Habsburg im-

perialism was opposed by Hungarian tradition of independence. The devastated areas were distributed among the members of a newly created aristocracy, to a great extent of foreign origin. The first three decades of the eighteenth century saw the rise of a series of great landed estates, sometimes covering hundreds of thousands of acres. On these lands, the new lords, under the direction of the Viennese government, proceeded to a resettlement on a great scale. Thousands of farmers from Germany, from Serbia, from Rumania, even from Eastern France and from Italy came to these empty lands, situated mostly in Southern Hungary. They were provided with agricultural equipment, live stock and money, and soon made this region one of the most prosperous areas of the country.

Thus, the Turkish wars, which created a virtual vacuum in the heart of the country, were followed by a resettlement of these areas by foreigners and resulted in a tremendous problem of national minorities. The existence of these national minorities led, finally, to the dismemberment of Hungary after the World War, on the basis of the Wilsonian principle of national self-determination. The creation of great landed estates, after the Turkish wars, led to grave consequences even in areas with a Hungarian majority. When, in 1848, serfdom was abolished, the existence of these estates was the greatest obstacle to the formation of a new, economically sound class of small farmers.

The period following 1848, especially the last third of the nineteenth century, was one of prosperity for Central Europe. Hungary created new industries, developed commerce and built railroads and highways. But the lot of the landless peasant was almost unchanged. In the feudal system, the village community afforded him a certain security, in spite of taxes and forced labor. With the

breakup of feudalism, the peasant was forced to rely upon individual resources which proved insufficient. In the twenty-five years immediately preceding the World War, over 1.5 million peasants left Hungary for the New World. Their place, in many instances, was taken by national minorities. In spite of frequent warnings, that the emigration of Hungarians coincided with the acquisition of Hungarian farms by national minorities, such as Serbians and Rumanians, nothing was done to alleviate the lot of the peasant.

Thus we see how the oppression of the serfs paved the way to foreign conquest, almost unopposed after an initial and fatal blow. The Turkish occupation and the campaigns of 150 years left a land of almost desert character, ready to be resettled by foreign farmers, on giant estates, created to break the resistance of an independent nation. And, finally, the existence of these great estates and the resulting power of landed property led to an unbearable pressure on the peasantry, to mass emigration and to the final dismemberment of the country in 1920.

The years following the World War brought a series of land reforms in most Danubian countries. Little has been done, however, in this direction in Hungary. The Hungarian land reform of 1920 created a number of new farms too small to produce a living to their owners. In spite of a series of bills introduced and passed by the Hungarian Parliament in 1935, 1936 and 1939, the situation is still very grave. Let us consider it in the light of the official statistical data of 1935.

II

As late as 1935, farms of less than 7 acres made up nearly three fourths of the total number of farms. The total area encompassed by them, however, accounted for about a tenth of the total

farm area only. Estates of over 140 acres, on the other hand, while accounting for 0.9 per cent. of the total number of farms, occupied nearly one half of the total farm area. The average size of the small peasant farms was but 1.8 acres, while the average of the great estates was 3,320 acres.

THE DISTRIBUTION OF FARMLAND IN HUNGARY
IN 1935

Size of holdings in acres	Number of farms	Per cent.	Area of farms in acres	Per cent.
Less than 7	1,142,294	71.5	2,450,000	11.0
7 to 14	200,341	12.5	2,043,000	9.2
14 to 140	240,761	15.1	7,400,000	33.4
140 and over	14,250	0.9	10,035,000	46.4
Total . .	1,597,646	100.0	21,988,000	100.0

Hungary, in the light of these statistics, is a country of extremes. On one side there are a large number of small agricultural units, "dwarf farms," as the Hungarian peasant refers to them. They are too small to support a family, except possibly in the neighborhood of the cities. There, the favorable conditions of a great market, the improved means of communication, the possibility of intensive methods of agriculture, such as truck gardening, orchards, poultry and dairying, might allow an agricultural worker and his family to subsist on a farm of 1.5 to 2 acres, or less.

On the other side, an extremely small group owns over one third of the country. These two categories, the "dwarfs" and the "giants," together make up more than half of the total agricultural area. The above figures, however, as far as the size of the farms is concerned, differ so radically from American conditions that it is desirable to state briefly the bases adopted for this classification.

A controversy of long standing has raged between conservative and progressive agrarian groups in Central Europe over the economic possibilities of small farms. There seems to be a general agreement, however, that farms under

the size of 7 acres can not support an average peasant family. This is possible only if one or several members of the family engage in some other occupation, mostly as agricultural workers on other farms.

The lot of the peasant is somewhat mitigated by the fact that, as a survival of the feudal system, many villages still possess common lands, used mainly for pastures and as forests. In any treatment of the Hungarian land problem these lands should be considered as really part of the small peasant farms. They represent 5.7 per cent. of the total agricultural area.

Between the "dwarf" and the "giant" landowners, there is a rather small group of more fortunate peasant farmers. Their farms range from 14 to 140 acres. This group accounts for about 14 per cent. of all farms, and 28 per cent. of the total farm area.

As to the great estates, they are not always owned by one individual. As a further obstacle to a redistribution of the land, more than one half of the great estates can not be sold except under certain conditions specified by law. Best known among these are the entails or "fideicommiss."

The institution of entails subsists only in Hungary and Germany in its true form. It is a safeguard of the great estates. They can not be divided or sold and are handled by the senior member of the family. Although somewhat diminished in importance after the World War, they still are of a great importance in Hungary.

Another category of great estates, those owned by the church, are subject to the same restrictions of sale as the entails. Concentrated mostly in the hands of the Roman Catholic Church, they occupy a surface almost equal to that of the small peasant farms (11 per cent.).

Finally, a considerable area is owned

by commercial enterprises, devoted to agricultural production of industrial raw materials, and by endowments, supporting religious and educational institutions.

III

The great landed estates are perhaps the most important problem Hungary faces to-day. In the past they were responsible to a large extent for the impoverishment of the peasants, forced many thousands into emigration and facilitated the formation of national minorities. To-day, their effect is that of conservatism, of obstructing by various means the creation of a sound economic basis for the nation by a more equal distribution of the land. To be sure, some of the great estates have, by the creation of model agricultural units, by the help they give to peasant cooperatives and in other ways, attempted to lessen the burden of the peasant. Still, the existence of the great estates is the major barrier to a better rural economy.

It should also be said that the existence of the great estates perpetuates the maladjustment of population distribution. The great estates have a population density of 10-15 people to the square mile, where areas immediately contiguous approximate or exceed 35-50 people to the square mile. The basis for this inequality is to be found in the agricultural methods as practised by the great estates. Their large-scale exploitation is considerably mechanized, using few farmhands, with the exception of harvest-time when workers from outside are hired. Thus many agricultural workers live in overcrowded villages surrounding the great estates, sometimes under poor living conditions. The statistics of population density and the distribution of great estates indicate a reverse proportion. The greater the area occupied by the great estates, the poorer the opportunities offered to commerce and industry, the lower the general living standard.

The land reforms in the Balkan countries, after the World War, were not prepared scientifically, and they did not provide sufficient capital for the new small farmers. A general decrease of agricultural production, for a period extending from five to ten years, was the result. This has been used as an argument against the creation of small farms. This argument states that the creation of small farms, worked by peasants, with their primitive techniques, would result in a sudden decrease of the agricultural production.

This is contradicted by an investigation conducted in 1935-1936 by the Hungarian Agricultural Union, representing the interests of the great landowners. It appears that the total revenue per land unit (1 Joch = 1.4 acres) is from 14 to 30 per cent. greater on small farms than on the great estates. It has been stated that the total number of cattle, for example, is 17.6 per cent. greater per land unit on the small farms than on the great ones. Finally, this investigation established the fact that the bulk of agricultural products sold either on Hungarian or foreign markets, and representing 70 to 75 per cent. of the country's total production, comes from small farms. However, the yield of the main cereal crops is 18 to 22 per cent. lower per land unit in the small farm. This is a result of primitive techniques and lack of agricultural machinery.

On the basis of these figures, it can be said that the small farms succeed better in the branches of agriculture that require intensive labor, such as dairying, cattle raising or truck gardening. Results are poorer when intensive use of capital, combined with high agricultural skill, is required.

IV

The solution that is first suggested is the creation of tenant farms on the great estates. To-day, the only important re-

gion in this respect is the neighborhood of the great peasant towns of the Hungarian Plains. There, small tenant farmers make a very prosperous living on truck crops, wine, fruits, tobacco and poultry.

The creation of the small tenant-farms has already been attempted in one notable instance. On an estate of 13,500 acres, owned by the Roman Catholic Educational Endowment in Eastern Hungary, 9,100 acres are cultivated by 756 tenant farmers, united in a cooperative. They cultivate four acres on the average, their fields being divided in four groups, on the basis of a four-year crop-rotation system. Their products are marketed by the cooperative, their purchases of industrial articles, of fertilizers, are made by the cooperative. This double function of collective marketing and collective purchasing enables the farmer to realize a substantially higher income. An investigation has stated that in the case of individual buying and selling, the farmer was 25 to 28 per cent. worse off than using the cooperative's services.

An additional reform might be a better agricultural education for the farmer. Agricultural education is a rather neglected branch of the general educational system in Hungary. Although during the past years some steps have been taken in this direction, by offering technical agricultural education in rural primary schools, still much remains to be done. It is necessary to open a large number of winter agricultural courses and winter agricultural schools. Winter term should be instituted in the three agricultural colleges, so far mostly specialized in the training of men for the great estates. The small farmer has to be taught the use of modern agricultural techniques. Mastering these, he will be able to obtain higher yields, to raise better cattle, to produce better fruits and vegetables.

As to reforms involving considerable

capital expense, in a country with small capital resources of its own, this is above all a matter of time. Among these reforms the building of new rural roads will aid in the transportation of agricultural products to the markets and will establish new cultural contacts between town and country. Irrigation is still another important reform in this category. The building of irrigation systems and the construction of new roads has already begun on a small scale. It is the amount of capital at the country's disposal that determines the pace of work.

Another important point is a general reform of land use methods. In many villages, small farms have been divided, mostly by inheritance, into even tinier strips of land. These strips, sometimes only a few yards wide, are often at great distances from each other. The farmer has to transport his plough, his fertilizers, his seed and himself from one end of the village fields to the other. The amount of labor wasted through this procedure is considerable. Some experts estimate it to be 25 to 30 per cent. of the total potential labor of the year. The process of unification of these tiny strips, however, is a complicated one. Each little bit of land has to be carefully evaluated, and the little strips exchanged between the farmers. This calls for arbitration and often results in long legal suits. In spite of these difficulties and of the considerable cost involved, this process is an indispensable feature of any land reform.

These suggestions are perhaps the most urgent among the many reforms necessary to a better rural economy.

They may act in multiplying the amount of land that actually exists, by increasing the production and offering new opportunities to the peasant.

Peasants all over the world, whether in Hungary, in Kansas or in China, consider land the most priceless treasure there is. Some years ago, a school teacher in a small Hungarian village gave a written test to his pupils. The question he asked was: "If you had 1,000 Pengös (the equivalent of about \$180), what would you do first?" And, with a striking unanimity, the little boys and little girls in that forlorn school of the plains answered: "We would buy land, cows, chickens, a pig, and be farmers on our own." Land is a magic word for them. It means better houses, better food, better clothing, it means happiness and prosperity, it means security, it means everything.

A war is being fought in Europe. Nobody knows what the outcome will be. But many people agree that it will bring poverty, famine, misery to many countries. It is a duty of every state, towards its citizens and towards the world, to create better living conditions in its territories. The pursuit of happiness, the major aim of our civilization, although temporarily overshadowed, must be the major goal of every government. And it can not be indifferent to Europe whether countries intend to preserve their antiquated social and economic structure, or whether they are willing to offer new opportunities to their citizens. By doing the latter, they would raise their living standards and make happier members of a new order that will arise out of the ruin and destruction of the present conflict.

ANT BEHAVIOR IN THE FACE OF OBSTACLES

By Dr. LAURENCE J. LAFLEUR

DEPARTMENT OF PHILOSOPHY AND PSYCHOLOGY, BROOKLYN COLLEGE

OCCASIONALLY in the state of nature ants must overcome obstacles placed between them and some object which they desire, such as their nest, food, water or young. More frequently, man himself places obstacles intended to keep ants from approaching his food, trees or gardens; or in the case of myrmecologists, to keep ants in artificial nests from leaving those nests. These situations occasionally call forth unusual responses on the part of the ants, and it is with these atypical responses that this paper is concerned.

One obstacle to ants is water and one variety of artificial formicary uses a metal trough filled with water to keep ants within fixed boundaries. Miss Fielde¹ noticed, however, on one occasion, that some *Stenama fulvum*, which had never previously had recourse to such a method, escaped by swimming. In the case of water used to keep ants from food, Sykes reports a similar case of swimming.

Of course, where water barriers occur in nature, it is usually possible for the ants to tunnel under the barrier, and this method is also reported occasionally to overcome other obstacles. A case of tunnelling under a log placed to obstruct an ants' pathway is reported by Ellendorf. McCook gives an illustration where ants tunnelled underneath an irrigation ditch, and Lincecum a case of tunnelling under a creek. This reminds one, of course, of the much-quoted observation of Clark that ants had tunnelled under

¹ A list of sources for all references has been prepared, and may be consulted at the Library of Congress and certain other important public and college libraries. If these are not convenient, the author will be glad to give information concerning any reference.

the Parahyba River "where it was as wide as the Thames at London Bridge." One of the most interesting observations along these lines is that of Belt,² who writes:

A nest was made near one of our tramways, and to get to the trees the ants had to cross the rails, over which the wagons were continually passing and repassing. Every time they came along a number of ants were crushed to death. They persevered in crossing for a while, but at last set to work and tunnelled underneath each rail. One day, when the wagons were not running, I stopped up the tunnels with stones; but although great numbers carrying leaves were thus cut off from the nest, they would not cross the rails, but set to work making fresh tunnels underneath them. Apparently an order had gone forth, or a general understanding been come to, that the rails were not to be crossed.

Where an arduous pathway is provided by the food placed above the ground and the nest in earth, ants have been known to cut out the long or difficult labor of climbing by having some of their number remain with the food and throw it down to the ground where others removed the food to the nest. There is an ancient observation by Aelian to this effect and modern ones by many observers.³

In discussing Jourdain, Cornetz suggests that ants may accidentally drop seeds with no intention of performing a labor-saving act, and adduces several observations to support this point. He considers the crucial point to be whether the ants continue to climb up and down while the seed was dropping. When this point was put to M. Charles Jourdain,

² Thomas Belt, "Naturalist in Nicaragua," pp. 83-84.

³ Bates, Belt, Besson, Combes, Gredler, Jourdain, Lund, McCook, Merian, Moggridge and Wasmann.

he replied that although he could not say that no ants continued to climb up and down, their numbers were certainly much reduced if not entirely eliminated. In general, most of the observations here recorded are expressed in such a way as to negative Cornetz' suggestion, while several are by observers of such standing that we may be sure that they would not write as they did unless the possibility of accident was, in their opinion, altogether out of the question. Miss Combes's experiments were directed to this question, and showed that the dropping was deliberate. On the other hand, some observations do not exclude this possibility, Lund in particular remarking that the ants often fell with the leaves they cut. Such behavior could still be intentional, amounting to saving the labor of descending but not of climbing; but the case is not clear.

A rather similar procedure consists in the ants' allowing themselves to fall from a height onto the goal which they seek to reach. Frequently when ants have been cut off by some device of water, glue or turpentine from food, they have climbed to the ceiling or overhanging nearby object and allowed themselves to drop thence onto the food. In some of these observations the ants then obtained their food and dropped with it to the ground. Observations of this type have often been reported.⁴ Lubbock⁵ wrote:

At a distance of ten inches from the door of a nest of *Lasius niger*, I fixed an upright wand, and from the top of it I suspended a second, shorter wand. To the lower end of this wand, which hung right over the entrance to the nest, I fastened a cell in which I put a number of larvae, and to them I put several ants. Though the drop was only a half an inch, the ants preferred the long route over the wands. They

⁴ Buckley, Dupont, Leuckart, Oestlund, Sykes, Titus, Vogt, who reports two cases, and Weir; and these observations have been confirmed by the experiments of Combes, Titus and Turner.

⁵ Sir John Lubbock, Lord Avebury, "Ants, Bees and Wasps," pp. 240-248.

showed anxiety to go up directly. The ants would not jump down, although the distance was decreased until the ants could touch the cell, and although the length of the wands was increased. Although sifted mould was placed underneath, the ants did not think of piling it till they could reach the larvae directly. An ant would remain a prisoner rather than drop a short distance. If a chasm was interposed between the ants and the desired larvae, they would not think of pushing a piece of paper or a straw across, although the straw was placed almost across already.

Turner on the contrary found that ants could learn to jump down, although he found that they showed reluctance in doing so. Miss Combes found in a number of experiments that the ants jumped down with practically no reluctance. She reports that there was considerable difference in the number of ants jumping when she used rods of different materials or in different positions. The ants apparently preferred to jump from smooth or horizontal rods, rather than from rough, vertical ones. When, in her second series, she repeated Lubbock's experiments exactly, she found that the ants always jumped. Miss Combes' experiments were performed with many nests but not with the same species as those used by Lubbock, which may account in part for the difference in results. Turner worked with several species. With *Camponotus pennsylvanicus*, I have several times observed a well-defined jumping that carries the ant forward as well as down.

A frequent method of protecting trees or other vertical objects is to band them with glue, or sometimes with a cloth soaked in poison. In such cases ants have been known to bring bits of earth and build a road across the dangerous point.⁶ The observations of Barber and Theuerkauf are particularly interesting. Barber, of the United States Department of Agriculture, reports that in general

⁶ Examples of this kind have been given by Barber, Besson, Fleury, Jourdain, Leuckart and Theuerkauf.

the banding of trees against ants is effective only a few days, as "the ants would carry particles of dirt and build a bridge over it." And Theuerkauf found that ants that were in a tree at the time when it was banded used aphids instead of dirt to build a pathway over the sticky substance. In some cases vessels filled with water have been filled up with dirt in similar fashion.

The commonest method used in the tropics to protect food from ants is to place the food on a stand whose legs are immersed in basins of water. In such circumstances and in other cases where water has formed a barrier to the ants, they have been known to build bridges of floating particles by means of which they gained access to the protected region.⁷ Concerning observations of the last two types Wheeler⁸ writes:

Several writers have described ants as building earthen bridges over sticky bands that at first prevented them from climbing trees, over water moats surrounding their nests, or over the surface of honey placed in their nests. In each of these cases the observer, a trained zoologist, regarded the act as due to reasoning, or at least, as the result of a "practical judgment." In reality, however, nothing more than a reflex or simple instinct was manifested in any of these cases. If the observers had had a more intimate acquaintance with ants, they would have known that these insects almost invariably throw earth, empty cocoons, or particles of debris on any liquid or viscid substance in their immediate environment. Such actions result in covering the whole surface of a small amount of liquid, so that the ants are able to cross over to the other side on what was never intended to be a bridge.

Wheeler's argument seems to me, however, not entirely to the point. That ants will cover sticky substances in their nests where such substances would be dangerous to themselves and their young is undoubtedly true. Such be-

⁷ Examples of this type have been given by Ellendorf, Fleury, Jourdain, Kühn, Turner and an anonymous writer in *La Nature*.

⁸ W. M. Wheeler, "Ants," p. 540.

havior is so regular that it might be called typical. But covering glue on vertical surfaces far from the nest is another matter altogether. It can hardly be thought that ants have the urge to cover all stickiness within a range of fifty yards of the nest: that they do not do so is a matter of everyday observation. Furthermore, it may be noted that Wheeler's explanation would not cover the fact that glue is not invariably coated with earth, and that where this is done it usually is done only over a narrow band sufficient to give easy access to whatever place the ants are seeking to go. In addition, Wheeler's explanation would fail to account for the apparently intelligent choice of floating materials often used in building bridges over water, and the behavior of ants who have been observed in the course of constructing these bridges.

Along these lines the most interesting observation is that of Turner:⁹

On the same Lubbock island I had a large colony of *Formica fusca* var *subsericea* Say. The island was kept littered with detritus of various kinds. One day I noticed a worker of this colony begin the construction of a bridge across the ditch of water that surrounded the island on which the colony was located. This partial bridge was constructed in the following manner. The ant placed a piece of charred paper about one centimeter wide upon the water on the inner side of the ditch. After walking out on this bit of paper and reaching outward with its antennae, the ant returned to the island and picked up a crumb of bread crust three millimeters wide. The ant then walked across the charred paper and placed this bit of bread upon the water just beyond and adjacent to the paper. After standing for a short time upon the outer edge of the crumb and reaching outward with its antennae, the ant returned to the island and picked up a piece of wood two millimeters wide by three millimeters long. This the ant placed upon the water just beyond and adjacent to the crumb. Thus there was constructed, extending three-fourths of the distance across the ditch, a bridge of three elements. Upon this partial bridge the ant stood for fully two minutes, reaching continually outward with its antennae. The bridge was never completed.

⁹ *Biological Bulletin*, Vol. 13, pp. 834-835.

Such evidence and such considerations as these force us to reject Wheeler's extreme position in favor of that of Cornetz, who not only pointed out, in connection with the observations of Jourdain, that the covering of irritating substances was typical, but showed by a series of experiments that such behavior could be induced outside the nest. However, he believes that ants show more than instinctive behavior in the choice of materials for building a floating bridge, and shows no disposition to insist that behavior of the type in question is always or necessarily a matter of reflex.

Some older observers, especially Merian, have reported that ants formed bridges built of their own bodies to gain access to various objects or to cross streams. This observation was characterized by Wheeler as a myth, but it has nevertheless been confirmed, at least in part, by several modern biologists of high reputation, including Beebe and Belt, who report this fact of the same genus of ants with which Merian was concerned. Similar observations on other species have been recorded by Dupont, Sykes and Vogt.

A most interesting case is reported by "E. D.,"¹⁰ who explains that he protected a meat safe in the ordinary manner by placing its four legs in tin vessels containing water. One day he found that some red ants were proceeding to the meat safe and discovered that they had built a bridge.

It consisted of a broken bit of straw, which rested with one end on a mud buttress fixed to the wall, and the other on the overhanging or projecting top of the safe, which came within an inch and a half of the wall. So they must have carried the straw up from the floor, and resting their end on the support they had prepared, let it fall until its other end reached the safe, and then crossed and completed the structure, for it was fastened at both ends with the mortar composed of their saliva and fine earth. Ruthlessly I destroyed the bridge, and moving

¹⁰ *Leisure Hour*, Vol. 29, pp. 718-719.

the safe farther from the wall, managed to prevent their inroads for that season at least. Since then I have frequently seen short bridges, composed entirely of the concrete or mortar which the white ants use to cover up their workings, extending from a damp earthen wall to anything not more than three-quarters of an inch from it.

- A unique method of overcoming obstacles was reported to me by Professor A. H. Phillips, of Princeton. He says:

I had some organic materials out in the sun to dry, and preserved them from attacks by ants by putting the table legs in dishes of water. But one day I found that the ants were carrying away my materials. Anxious to trace them, I watched, and found that the ants, laden with food, were waiting at one side of the table. As a leaf of a nearby cocoanut palm swayed in the wind, it touched the table at this point. The laden ants quickly caught hold of the leaf, while others, unburdened, got off. It was just like human beings waiting for a train.

Several observations of the same type are recorded by Woglum.

Without special consideration, the various methods reliably reported to have been used by ants to overcome obstacles would make it seem that their intelligence is remarkably high and that no ordinary method of preserving food is apt to be successful against them. This, of course, is not a correct analysis of the situation. The essential fact is that placing the legs of an article of furniture in water normally does protect articles on that table from attacks by ants, and the banding of trees is frequently if not regularly effective in similar fashion. The forty-odd examples mentioned in this article are, of course, atypical. If they were not, they would not have entered into the literature of myrmecology in the way that they have. So it is not to be expected that every experiment with ants will show them to possess the ingenuity, or whatever quality may be exemplified, which was shown in the cases considered here. It must not be thought that favorable results would be obtained with any degree of

frequency, and there is therefore nothing at all surprising in the negative results obtained by Lubbock. In cases of this sort, where we are dealing with atypical behavior which may be rather rare in nature, the single positive result is of more importance than any number of negative ones.

There are two considerations which make it extremely unlikely that the happenings reported in this article should be interpreted as accidental or instinctive. The first is that in every case mentioned, with one possible exception, the ants had access to their goal before a barrier was interposed between them. Thus it is under conditions most likely to induce purposive efforts to achieve a goal that the successes actually reported have been achieved. This would seem further to discount Wheeler's position, since banding on trees not previously used by the ants has never been reported covered by them.

The second point of importance is that in most cases a considerable delay ensued after the obstacle was put into position before the ants overcame it. Placing a band of glue around the trunk of a tree did not ordinarily cause the ants to respond by covering it with dirt immediately, but instead a period of hours or days elapsed in which nothing whatsoever was done, and then the ants proceeded to cover the band with their accustomed ardor. These considerations seem to discredit any interpretation based on instinct, chain reflex or other similar concept.

Most myrmecological psychologists—and the present writer is in whole-

hearted agreement—believe that there is considerable variation in the intelligence of ants, not merely from species to species but from nest to nest within the same species, and from individual to individual within the same nest. This has been objectively demonstrated by the maze-running tests of Schnierla. And if this is so we can understand immediately how Lubbock's observation of his nest of *Lasius* produced consistently negative results, while the present author's experiments on his nest of *Formica* produced regularly favorable results; how on the question of jumping Lubbock, Turner and Combes reach divergent conclusions; and even how two such great myrmecologists as Lubbock and Forel could get different results from similar experiments on recognition, and each confirm their own results by repeated checks. If such individual variations exist, we might expect that ants who successfully overcame one obstacle would be apt to succeed in overcoming further ones. And this we find to be true in no less than five of the observations considered in this article. Thus Besson, Leuckart and Vogt observe the same ants to use two methods of overcoming obstacles, while Jourdain and Sykes similarly found three. This result is not unexpected. It is natural if success in overcoming obstacles is due to greater sagacity, to greater quickness in perceiving the applicability of accidental responses, to greater perseverance or even to the encouragement which the successful solution of the first problem might give to the ants when presented with a second difficulty.

BOOKS ON SCIENCE FOR THE LAYMAN

THEORIES AND PRACTICES OF A RENAISSANCE DOCTOR¹

ONE of the strikingly forceful personalities in the history of medicine, and indeed in the history of human thought, rejoiced in the name of Philip Theophrastus Bombast von Hohenheim; he is better known to us, as he was to his contemporaries, as Paracelsus. He was born in 1493 in Switzerland, studied medicine in Italy, traveled over the whole of Europe, from the British Isles to Poland, Turkey and Greece, and died in 1541 in Salzburg, misunderstood, poor, disappointed and prematurely old. Yet so significant a figure is he that last year, in observance of the 400th anniversary of his death, the American Association of the History of Medicine held a Symposium on Paracelsus. In further observance, the present volume of translations has been prepared.

Paracelsus was in many ways the Luther of medicine. In his day the dogmas of Galen were blindly followed, and original observation or deviation from the prevailing beliefs as to the causation or treatment of disease called for condign punishment. Indeed, many of Paracelsus' travels were due directly to the wrath of organized medicine. As for what we now know as mental disorders, the field was largely preempted by the clergy, with their beliefs in demoniac possession and witchcraft.

Many of Paracelsus' writings were not published until after his death (in many cases earlier printing was prevented by his enemies, the professors of medicine); by then his originality and his contributions to medical learning had begun to be appreciated. The first of the present treatises, known as the Seven Defensiones, did not appear until the author had been in his grave 23 years! He

¹ *Four Treatises of Paracelsus*. Edited by Henry E. Sigerist. xii+256 pp. Illustrated. \$3.00. 1941. The Johns Hopkins University Press.

freely pleads guilty to lack of respect for medical tradition unless it has more than mere age to recommend it. He searches for further knowledge, and seeks to be a true Christian in ministering to the sick. Yes, he has used new remedies; all effective remedies are poisonous in excess, but he knows the proper dosage of what he uses; more than can be said of his traducers! Yes, he has traveled widely; how better increase one's knowledge? "Medicine is an art which should be employed with much conscientiousness and much experience, also with much fear of God; for who fears not God, blunders and steals for ever and ever; who has no conscience, has no shame in him either."

The second treatise, "On the Miners' Sickness," has the distinction of being the first monograph on occupational diseases. As Paracelsus points out, we are likely to continue to have hazardous occupations with their attendant disorders; "Besides, we must also have gold and silver, also other metals, iron, tin, copper, lead and mercury. If we wish to have these, we must risk with body and life in a struggle with many enemies that oppose us. . . . And in the same manner as the devil is driven out of man, the poisonous diseases are expelled by means of such physic, just as evil expels evil and good retains good."

Treatise Three is entitled "The Diseases that Deprive Man of his Reason, such as St. Vitus' Dance, Falling Sickness, Melancholy, and Insanity, and their Correct Treatment." Although he subscribes to the doctrines of the influence of the moon and obsessions of the devil, he gives us some startlingly accurate observations on epilepsy, mania and hysteria (which he terms chorea lasciva). He even recommends an early form of "shock treatment"—"The best cure, and one which rarely fails, is to throw such persons into cold water."

The fourth Treatise is "A Book on

Nymphs, Sylphs, Pygmies and Salamanders, and on the other Spirits." This essay is largely interesting as illustrating the survival of pagan mythology within the framework of Christianity. Not only were there angels, but there were pygmies, giants and nymphs, and why not?—God is almighty, and able to create such things. They crave human companionship, and must be treated kindly; if a nymph marries a man, she receives a soul through the sacrament of marriage. Let him scoff who never knocked on wood as a tribute to the forest people!

The volume is a valuable contribution to the historical literature. It presents in convenient and readable form the views on medicine, folk-lore and Christian living of one of the most colorful and forceful personalities of the Renaissance.

WINFRED OVERHOLSER

DO PHYSICAL THEORIES SUPPORT PHILOSOPHICAL DOCTRINES?¹

It is said that when the famous German mathematician, David Hilbert, was asked to address the joint session of the Congress on Mathematics and Engineering for the purpose of smothering somewhat the existing feeling of mutual disrespect between pure mathematicians on one side and technically minded engineers on the other, he began his address with the following words:

"There exists an opinion that mathematics and technics are hostile towards one another. This opinion is, however, not correct. Mathematics and technics are not hostile towards one another; mathematics and technics have never been hostile towards one another; mathematics and technics will never be hostile towards one another; mathematics and technics can not be hostile towards one another, because mathematics and technics have absolutely nothing in common."

Whether or not these not very tactful

¹ *Between Physics and Philosophy*. Phillip Frank. 238 pp. \$2.75. 1941. Harvard University Press.

words of Hilbert describe correctly the relation between pure mathematics and its technical applications, they certainly can be applied very successfully to the relationship between theoretical physics and various philosophical systems.

Through the entire history of exact science, its findings were being used by philosophers (often with a century or so of delay) for the support of their own views and for discrediting the views of their philosophical opponents. One often hears about materialistic physics of the time of Isaac Newton, and the idealistic tendencies of relativity and the quantum theory. To take a most striking example, the recognition of "world-eater" was made compulsory, and the Heisenberg's "uncertainty relations" were strictly prohibited in the Soviet Russia, since they have been considered as contradictory to state—philosophy of dialectic materialism. On the other hand, idealistic philosophers would object to many other concepts of modern physics which would seem to them too materialistic. The aim of Professor Frank's book is to show that physical theories of to-day have absolutely nothing to do with different rivaling philosophical points of view, and "can be used for such arguments only if one interprets them according to the pattern of some cherished philosophy, disregarding the scientific meaning of modern physics." The author shows that "with the right interpretation, the results of twentieth century science can be used just as much and just as little as a characteristic of the change from materialism to idealism as the result of the physics of Newton or of any other period."

Being thus excommunicated from philosophy, the principles of physical science should be developed into a strict and unique logical system, in the construction of which "one must be careful to distinguish an experimentally testable assertion about observable facts from the proposal to represent the facts in a certain way by word or diagram."

This line of thought, which, in a certain sense (but a "good one" this time), can be also called a "philosophy" was started by the Austrian physicist, Ernest Mach, and a good part of the book is devoted to the analysis of Mach's ideas and their further developments.

In other chapters the author analyzes such fundamental questions as the notion of "length" in Einstein's theory of relativity, Bohr's notion of "complementarity" in modern quantum theory, and its relation to the problem of *determinism* or *indeterminism*.

On the whole, the book will be very interesting reading for those who are not satisfied with the knowledge of factual findings of modern science, but want to know more about the fundamental principles and the construction of a logically self-consistent system of physical theory.

G. GAMOW

SCIENCE FOR HIGH SCHOOL STUDENTS¹

THIS is an excellent modern text-book in general science for the ninth-year pupil or for the first year of high school. Every subject is presented as a question to be thought through and tested experimentally. The cumulative effect of establishing the scientific attitude and the scientific method is impressively successful.

The argument of such a text must rest upon the experiments and, in the first instance, on adequate drawings to represent the tests and the results. Hence the book is profusely illustrated and the clarity of both drawings and photographs has not been equalled. They are both convincing and fascinating.

In every respect the book is "teachable." There are ten units: air, water, food, sun energy, health, universe, weather, natural resources, communication and transportation, and reproduction. Each is divided into several chap-

¹ *Science on the March*. John A. Clark, Frederick L. Fitzpatrick and Edith Lillian Smith. Illustrated. xxvii + 572 pp. \$1.72. 1941. Houghton Mifflin Company.

ters, 26 in all, and each chapter into four problems. Each chapter also carries review questions, applications to daily life and suggested activities for science clubs and leisure time. Each unit concludes with a summary, a test and suggested readings. All three authors are able teachers and have focussed here the painstaking experience of many years of teaching these young students.

This is definitely a book for study. It is not readable in the sense that a book for the layman is supposed to be. For that reason the title is perhaps too attractive and a bit misleading. It is not an adventure story nor an account of recent progress, as the title might imply. But it is a sound, expert and attractive textbook for children and a fine teacher for adults who seek an explanation of common phenomena and who want to learn to think scientifically.

GERALD WENDT

FIRST AID FOR THE GARDEN¹

THE pest control measures called for each month—March to November—for gardens in the latitude of New York City are first tabulated, then concisely discussed. The pests and disease agents of ornamental herbs, shrubs and trees are made realistic by many line drawings and a few fine half tones. The new edition follows the arrangement for the first, with new material added in a chapter "After Four Years" and in one chapter each for garden troubles in the Middle West, the Southeast, the Southwest and California.

Dr. Westcott, technically trained and a practicing "plant doctor," is both sound and practical. No other book in English covers the pests and diseases of ornamental plants under one cover. The treatment is far less technical than German works in this field, and will not prove discouraging to authentic amateurs.

PHILIP BRIERLEY

¹ *The Plant Doctor*. Cynthia Westcott. Revised Edition. Illustrated. xx + 297 pp. \$2.00. 1941. Frederick A. Stokes Company.

THE PROGRESS OF SCIENCE

DEDICATION OF THE NATIONAL OBSERVATORY IN MEXICO

THE Inter-American Congress of Astrophysics, sponsored by the Government of Mexico in connection with the dedication of the new National Observatory at Tonanzintla, was characterized by two principal features, the quality of the many scientific contributions and the outstanding hospitality of our hosts. To most of the American scientists the congress provided a first visit to Mexico. The deep interest in science of the Mexican Government as evidenced by the President, General Manuel Avila Camacho, by the Governor of the State of Puebla, Dr. Gonzalo Bautista, and by many other Mexican officials, was a source of profound satisfaction to the twenty-seven scientists from the United States.

The dedication of the first Astrophysical Observatory of Mexico, on the morning of February 17, provided a spectacle that stands unrivalled in the mind of the writer. Ten thousand people of Mexico, mostly Indians, assembled before the new buildings of the observatory. With sev-

eral bands, with innumerable flags and with holiday regalia, they had come, some from great distances, to dedicate an institution for pure scientific research. The picture of their upturned faces before the magnificent snow-capped peaks of Popocatepetl and Ixtaccihuatl is a symbol of Mexico, the new Mexico, that has chosen science to replace superstition.

From Mexico City, the town of Tonanzintla lies some 80 miles south of east, directly beyond the two great volcanic peaks. The region is a high rolling plateau, some seven thousand feet above sea level. The clear skies and uniform pleasant climate provide an excellent situation for astronomical observations. The new 27-31-inch Schmidt telescope, one of the three largest lens-mirror combinations in the world, commands not only the northern hemisphere of the sky, but also nearly all the southern hemisphere. Thus the Mexican astronomers have an opportunity to probe, with a new type of telescope, unstudied depths



INAUGURAL CEREMONIES BEFORE ONE OF THE NEW BUILDINGS

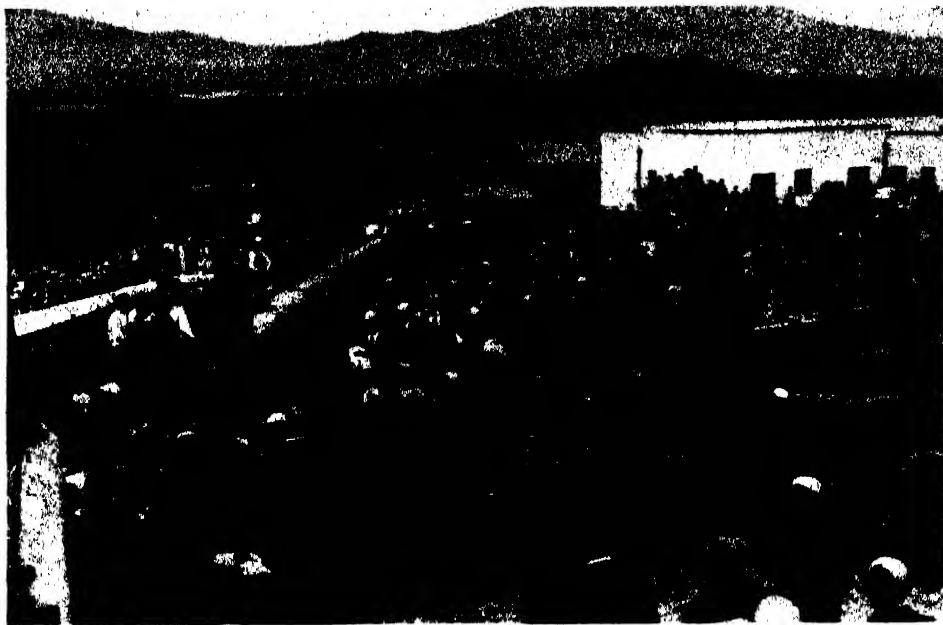

GENERAL MANUEL AVILA CAMACHO, THE PRESIDENT OF MEXICO
WITH THE PRESIDENTIAL PARTY EN ROUTE FROM THE LIBRARY BUILDING TO THE NEW TELESCOPE.

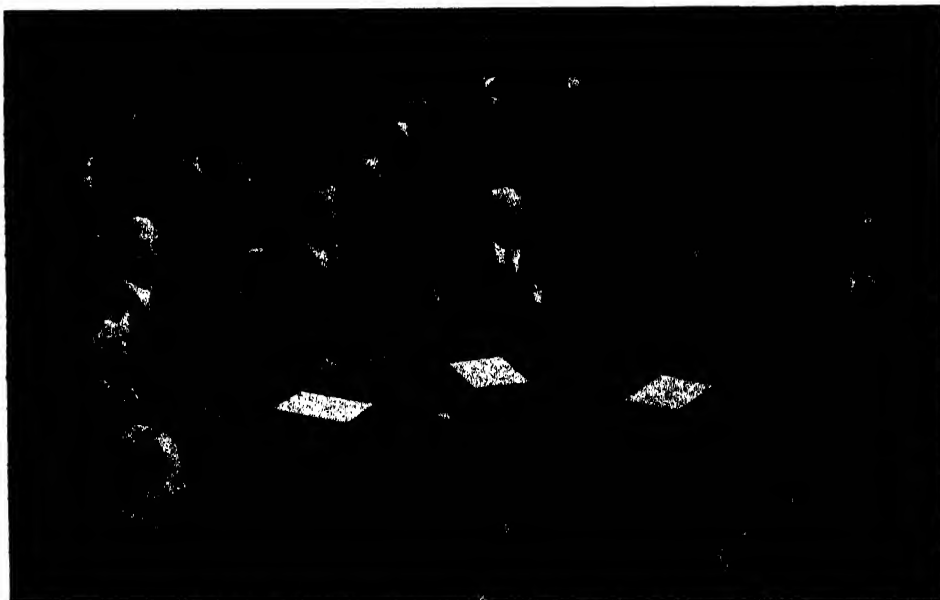

DISTINGUISHED SCIENTISTS AT THE DEDICATION
AROUND THE TABLE FROM LEFT TO RIGHT: PROFESSOR MANUEL S. VALLARTA, OF MASSACHUSETTS
INSTITUTE OF TECHNOLOGY; DR. HARLOW S. SHAPPEY, OF THE HARVARD COLLEGE OBSERVATORY;
GENERAL RODRIGUEZ, FORUM PRESIDENT; PRESIDENT MANUEL AVILA CAMACHO; DR. RICARDO MONGES
LOPEZ; DR. GONZALO BAUTISTA AND VEJAR VASQUEZ, SECRETARY OF EDUCATION.

of the Milky Way. The organizer and director of the National Observatory, Senor Luis Enrique Erro, plans to engage in systematic studies of the structure of our local universe of stars.

The American scientists arrived as a group at Mexico City on Sunday morning, February 15. Some used the day to orient themselves in this rapidly growing cosmopolitan city, while others simply relaxed after the strain of travel in an unaccustomed altitude. On Mon-

The week at Puebla was almost entirely occupied with scientific meetings and official ceremonies. Some of the wives and a few of the scientists with tourist instincts took advantage of an occasional opportunity to slip out and bargain with the tradespeople for a cactus tablecloth or an onyx ashtray. But the business at hand was science, and it demanded one's complete attention.

The astronomical papers of the congress dealt primarily with problems of



DR. ENRIQUE ERRO, DIRECTOR OF THE OBSERVATORY, LEADS A TOUR
 DR. ERRO, RIGHT HAND EXTENDED; PRESIDENT CAMACHO, LOOKING UP; DR. BAUTISTA, GOVERNOR OF PUEBLA, STANDING BEHIND DR. ERRO; DR. CARLOS GRAEF, ASSISTANT DIRECTOR OF THE TONANZINTLA OBSERVATORY, IN THE LEFT FOREGROUND; DR. GEORGE Z. DIMITROFF, OF HARVARD UNIVERSITY, TO THE LEFT OF DR. GRAEF; PROFESSOR VALLARTA BEHIND DR. DIMITROFF.

day, following a brief visit to the pyramids of Teotihuacan, we were taken by automobile over the winding mountain roads through the forest slopes of Mount Ixtaccihuatl to the city of Puebla. There we were formally welcomed in the evening by Governor Bautista. From Puebla, on Tuesday, we attended the dedication ceremonies at Tonanzintla, some ten miles distant.

Milky Way structure, and more broadly with related problems of stars, stellar evolution and the material between the stars. No adequate review of the many contributions is possible in this limited space, but a few examples may be cited. Dr. Walter S. Adams, director of the Mount Wilson Observatory, opened the congress with a complete discussion of the atoms and molecules now known to

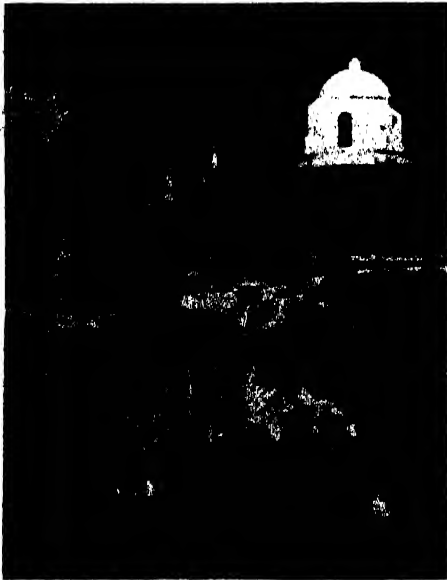

OBSERVATORY BUILDING TOWER

exist in interstellar space. The most recently discovered atom is that of iron. Dr. Adams demonstrated that the atoms and molecules are irregularly distributed in space, actual moving clouds being detectable. Dr. Joel Stebbins, president of the American Astronomical Society, from his photoelectric studies of the reddening of distant stars, showed that the irregular dust clouds of interstellar space possess a surprising uniformity—the distribution of particle sizes and possibly the constitution appear to be constant, independent of the opacity of the cloud or its direction in space.

The perplexing problem of the evolution of stars was attacked by Professor Henry Norris Russell, of Princeton, and touched upon by Dr. Otto Struve, director of the Yerkes and McDonald Observatories. On the basis of the modern theory that stellar energy is derived by atomic transmutations, Professor Russell showed that a time scale much greater than three billion years would require an unobserved excess of stars that equal the

sun in mass, but that are much brighter and hotter than the sun. He pointed out, however, that the white dwarf stars appear to be too old, and the supergiant stars too young, for such a short time scale of evolution. Dr. Struve discussed the rotations of stars, presenting new observations that challenge all theories of stellar evolution. The hot massive stars of the Pleiades are all rotating at high speeds, dangerously near the stability limit, while the stars near the center of the cluster turn even faster than those near the edges.

Results as to the detailed structure of the Milky Way were presented by Dr. Harlow Shapley of Harvard and his collaborators. Dr. Shapley's studies of the distant variable stars have pushed the outer edge of the Galaxy to a distance equal to our distance to the center, about thirty-thousand light years.

Filled with such new astronomical knowledge we returned to Mexico City for a Sunday of needed rest and relaxation. Monday saw our automobile cavalcade, escorted by motorcycle policemen, over the mountainous roads some two hundred miles west to Morelia. Just before dawn on Tuesday, we were awakened by band music and firecrackers. It was Flag Day. From this early awakening, we proceeded to the picturesque village of Tiripetio, in which are located the reconstructed buildings of the Col-

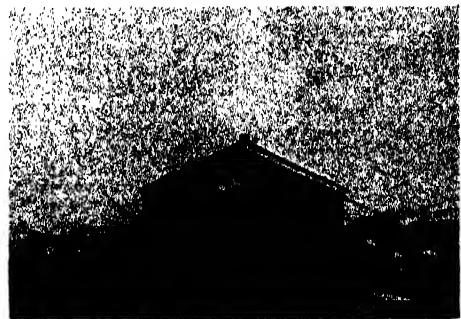

STRUCTURE HOUSING THE TELESCOPE WHICH IS LOCATED AT PUEBLA, MEXICO.

legio San Nicolas, founded in 1540. In this, the oldest university of the American continents, honorary degrees were awarded to Drs. Adams, Russell, Shapley and Vallarta.

Tiripetio proved to be our one opportunity to observe a natural Mexican village, unspoiled by modernism. The members of the band wore serapis and overalls, while the oxen were decorated with flowers for the great occasion. Education, however, is an important factor in this small village. The school children were all on their best behavior because the school was being inspected by government officials.

During the remaining two days spent at Mexico City, the members of the congress were honored with a luncheon given by President Manuel Avila Camacho in the National Palace, and with a luncheon given by the American Embassy through the courtesy of Ambassador and Mrs. George S. Messersmith. A geophysical conference at the University of Mexico provided mental food during these last



MARIMBA PLAYERS AT MIL CUMBRES

days, and finally the members of the congress dispersed regretfully on Thursday, February 27.

Of many disconnected memories, the writer recalls vividly the remarkable English-Spanish and Spanish-English translations of scientific papers by Dr. Carlos Graef and Alfredo Banos, the diplomatic smoothing of our travel path by Senor Salvador Duhart, first secretary of the Mexican Embassy, the feel of crisp cool dry air under the bright Mexican sun and the music of the marimba at Mil Cumbres on the trip to Morelia.

From the many pleasant contacts with the Mexican people of all classes, from the scientific understanding of our Mexican colleagues and from the great interest of the Government of Mexico in our welfare and activities, we carried away the fine impression that there is a true and binding tie of friendship between the United States of Mexico and the United States of America.

FRED L. WHIPPLE

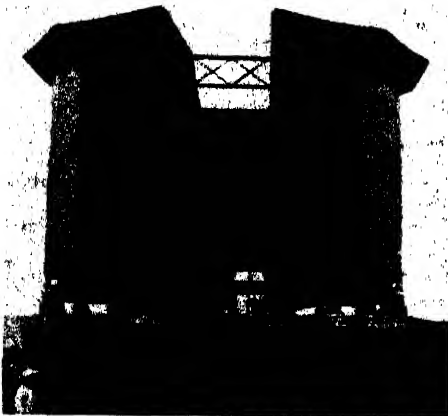

THE NEW 27-31-INCH TELESCOPE
THIS SCHMIDT PHOTOGRAPHIC TELESCOPE AT THE
NATIONAL OBSERVATORY AT TONANZINTLA WAS
BUILT AT THE HARVARD OBSERVATORY UNDER THE
DIRECTION OF DR. DIMITROFF.

**ELSIE CLEWS PARSONS, LATE PRESIDENT OF THE AMERICAN
ANTHROPOLOGICAL ASSOCIATION**

ELSIE CLEWS PARSONS died on December 19 shortly after a field trip to South America and just before the meeting of the association over which she was to preside. It is difficult to do adequate justice to her work and her personality. Born under circumstances that would have shaped her life in a conventional pattern, her eagerness for knowledge and her keen interest in human affairs made it possible for her to follow serious studies without breaking with the exactions of social life. After graduation from Barnard College in 1896 she continued her studies under Giddings, and began to teach and to write. Her early work is characterized by a strenuous revolt against convention, by a clear recognition of the historical origins of our institutions which, in our modern, complex society, have lost much of their meaning. It exhibits a courageous expression of a purely intellectual criticism of fundamental forms of our modern ways of life. As time went on this critical attitude led her to the unavoidable desire to learn how other societies have solved the problems that beset us. Thus she turned from a sociological study that lays primary stress upon the complexities of our culture to the wider inquiry, the question of the manner in which more primitive or alien societies have solved their problems—a necessary preliminary of the study of what is generally human and of what is historically determined. The position of women in society, the forms of the family, demanded inquiry from a wider point of view. In the United States we are in the fortunate position for those who study problems of this type that much remains in the culture of our native Indian population and in that of the poor Negroes that lends itself to factual investigation. Dr. Parsons embraced this opportunity avidly and spent unlimited time and energy in

the study of these remains. She was attracted by the ceremonial life of the sedentary Indian tribes of Arizona and New Mexico and became the most outstanding authority on this subject. It is fortunate that it was given to her to complete her comprehensive work on the religion of the Pueblo Indians in which she combined her own rich studies with the available printed and manuscript resources. In her researches she welcomed the help that other competent observers were able to give, and much of the research work that has been done during the last few decades is due to her stimulation of young scientists, to whose attention she called problems and whom she enabled to carry through field work that otherwise would have remained undone. It was her good fortune that she was able to render such material assistance. It was her merit that her devotion to science prompted her to use her position unselfishly for the promotion of scientific work that she considered important.

In the pursuit of her southwestern studies the influence of Spanish culture upon native life became a problem of paramount importance. It attracted her not only as a local problem, but rather as a study that throws light upon the processes involved in the history of culture, for we find here cultures not yet overwhelmed by modern civilization but who have worked out a compromise between the old and the new. The richest fruit of her studies on this subject is her book "Mitla, Town of the Souls, and other Zapoteco-speaking Pueblos of Oaxaca in Mexico." During the last few years she extended these inquiries, which had a great fascination for her, over South America also. It is undoubtedly due to this interest in historic amalgamation rather than in the extermination of foreign cultures that she gave consider-



ELSIE CLEWS PARSONS

able time to the collection of data on Negro folk life, both in North America and in the West Indies. Although cultural survivals are scanty in most parts of North America, the more southern regions, the West Indies and South America, present interesting problems of intermingling of cultures.

In contrast to her early sociological work her later work shows a most conscientious desire for factual accuracy. For this reason many of her books are source material which furnish the basis for her short theoretical papers.

The experiences gained by personal, intimate contact with the forms of foreign cultures and with individuals living in these cultures was for her not only a method of scientific inquiry but also a guide to life. Understanding the emotional appeal of historically conditioned behavior, she recognized the difficulties

of a purely intellectual attack upon catch phrases and meaningless symbols, but demanded of herself and leaders of public opinion the highest degree of intellectual honesty that requires the willingness to subject the emotional attachment to custom to rigid intellectual inquiry and to accept the results of the latter as guides of action.

Her unselfish devotion to science has few equals. Always ready to help young scientists in the wide domain of anthropological research and particularly of her own chosen field, she has done much to advance anthropological work in our country. The only return she demanded for her help was industry and serious work. Without her help many of the important contributions of late years would not have seen the light. Her interest in folk-lore as a source of the understanding of culture and cultural

processes led her to the most liberal support of the American Folk-Lore Society, whose broad field of publication and research was made possible almost entirely by her generous support.

In her own life she was uncompromising where her convictions were concerned, ready to recognize the good even in forms not congenial to her indepen-

dent mind, and unselfish in all her thoughts and actions.

We lament her loss, but the memory of her devotion to her ideals will live on among us and lead us to emulate her example, intolerant towards ourselves, tolerant towards others, disdainful of all selfish pettiness and truthful in thought and action.

FRANZ BOAS

THE "QUEEN" OF MESCALITAN ISLAND

FIFTY years ago Mescalitan Island was surrounded by the waters of the Goleta Estero. To-day, the estero has filled with muck from the erosion of the nearby mountains, and the Santa Barbara (California) airport occupies the place where, five hundred years ago, a great Indian village stood.

Prior to the construction of the airport, an expedition of the Santa Barbara Museum of Natural History made excavations which have yielded some of the most interesting and valuable data yet uncovered upon the phases of the *Canalino* culture of the Chumash Indians.

Certainly it has yielded one of the most interesting single specimens of American Indian yet brought to light.

A total of seven burial grounds were found. In each a different custom prevailed as to the method of interment and accompanying artifacts. Each of these burial plots represents a phase of the *Canalino* culture which to date had not been recognized. In one of these earlier cemeteries, the skeleton of a young woman(?) was uncovered—the skeleton having been buried upon the highly decorated shoulder blade of a whale, which acted as a bier.



EXCAVATORS AND SKELETON
WITH STONE BOWL IN LATE CANALINO CEMETERY.



SKELETONS OF THREE INDIVIDUALS
BONES OF AN ADULT AND CHILDREN.



Background by Stanley Edwards

THE MESCALITAN ISLAND GRAVE IN THE SANTA BARBARA MUSEUM

The *Canalinos*, or "Channel People," buried their dead face down, arms and legs drawn up in the flexed position. Usually a few shell beads accompany the skeleton—sometimes a bowl of sandstone or steatite, together with bone or stone implements.

On very rare occasions the later phases covered the grave with slabs of whale bone, which served to mark the grave and to protect it from marauding animals. This is the only case in which the whale bone has acted as a bier upon which the body lies.

The whale scapula is decorated with *Olivella* disc beads around the rim, inlaid by the use of asphalt. The spine was

removed by careful carving and two large abalone shells countersunk into the bone on either side of the skeleton. These abalones are surrounded by a border of the small *Olivella* disc beads. Here and there, throughout the distal end of the scapula, the calluses of the Giant Keyhole Limpet are inlaid. These calluses are the hardened rims of the orifice of the shell and make elongated rings.

The skeleton also had a string of steatite beads of unique design strung across the shoulders. These are long tubular beads of black steatite with *Olivella* inlay about the center. Beside the skull a small sandstone bowl, inlaid around

the rim, was found, while down the spine a string of *Olivella* beads was stretched and short strands were found about each knee.

The entire skeleton was excavated in one block and moved to the Santa Barbara Museum of Natural History, where it has been installed as a "habitat

group"—if a dead Indian can be said to have a "habitation"—complete with the excavation and tools used in the work. A painted background showing the surrounding country gives a convincing picture of the region occupied by the early Indians of Santa Barbara.

PHIL C. ORR

CAMOUFLAGE EXHIBIT AT THE FRANKLIN INSTITUTE

Is camouflage really important to national defense? Can we save strategic military locations from air attacks by making airports look like cornfields and factory roofs resemble swimming pools? To show some of the ways camouflage can be made effective, the Franklin Institute recently opened an extensive exhibition in cooperation with the War Department and the Philadelphia Council of Civilian Defense.

The historical background of camouflaging is a long and interesting one. The Bible tells how Rahab concealed

spies under stalks of flax on her roof, and the wooden horse at Troy was the deciding factor in the victory for the Greeks. In the records of the Civil War, it was written on April 18, 1862, that while sailing up the Mississippi, past enemy forts, Admiral Porter ordered all the masts of the ship to be covered with branches to make it appear less conspicuous. In World War I, black stripes were painted on the sides of battleships and destroyers to deceive the eyes of the attackers in judging their direction. Dazzle painting was used to make it difficult for enemy



A RESERVOIR, TOP CENTER, AS IT APPEARS WHEN UNCAMOUFLAGED TERRAIN CAMOUFLAGE IS SHOWN BY THE RAILROAD TRACKS TUNNELED WITH GARNISHED NETTING AND THE FALSE RAILROAD BRIDGE "ONE MILE" TO THE RIGHT OF THE ACTUAL BRIDGE.



THE SAME RESERVOIR AFTER CAMOUFLAGING

THE GARNISHED NETS WHICH ARE USED TO CONCEAL THE RAILROAD BRIDGE WOULD BE DROPPED DURING A RAID TO ELIMINATE THE SHADOWS ON THE LEFT SIDE AND REFLECTIONS ON THE RIGHT.

submarines to sight the most vulnerable parts.

Military authorities agree that the more industrialized a country is, the more vulnerable it is to attack. So now we must plan effective concealment not only from the ground and sea, but from the air as well.

For years, Germany has been perfecting its methods of camouflage. In one branch of their protective endeavor, British women are constantly making patterns on nets to cover their tanks in the field. If camouflage is to be successful in this country, means must be found to conceal radio towers, oil storage tanks, giant power houses and many other important industries.

This exhibition explains how some of these problems can be understood and solved. By using scale models of the areas of production, the appearance is shown before and after camouflage.

One model shows how modern, arrow-

straight, slashed-through super-highways, perfect though they are in peacetime, are easy bomb-targets for speeding enemy planes. By way of contrast, long curved highways which follow the contours of the landscape are more suitable for trucks and tanks to seek refuge in the foliage on the side of the road if an air raid should occur. The turns and twists make it almost impossible for flights of planes to follow the road with either bombs and bullets.

Another model deals with the problem of "hiding" a railroad bridge by placing a false one about a mile away. During a raid, painted nets are lowered on both sides of the real bridge—on the north to kill the shadow and on the south to eliminate bridge reflection.

Even an amateur could spot a factory from the air, just by the roof and the rows of parked cars near it, which are ample identification. In camouflage, effort is always made to have these build-

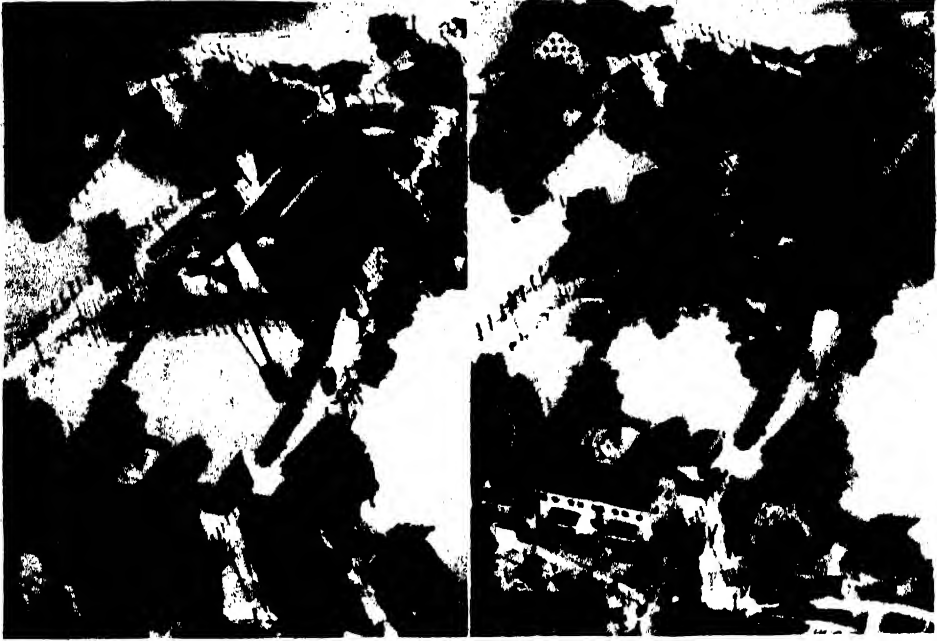

CAMOUFLAGING A LARGE INDUSTRIAL BUILDING IN A RURAL DISTRICT
Left: IN THE UPPER PART OF THE PICTURE IS THE BUILDING BEFORE CAMOUFLAGING. Right: FALSE TREES AND DUMMY STRUCTURES MAKE THE BUILDING BLEND WITH THE LANDSCAPE.

ings fit into the natural landscape. In rural districts, false trees and dummy buildings help make this possible. In one model, the roof is covered with luminous paint, and weeds and rough grass are put around the edge to make it look like a stagnant pool.

Saw-toothed roofs can be constructed to look like swimming pools in southern climates, or skating rinks with toboggan slides in the snowy regions. In either case a parking lot can be turned into a baseball diamond and the cars parked under nearby shrubbery. The factory windows are varnished and powdered to remove the shine.

It has proved effective to camouflage even the soldiers. White is worn by snow troops, and printed cotton suits are used in other sections to fit into nature's background.

All these models may be seen from a balcony at the Franklin Institute. Some are built to scale so that when looking

down at them the visitor has the same view a pilot has at 20,000 feet. This helps to give an idea of the tremendous precision that is necessary to hit the target, and how easily well-planned camouflage effects can completely confuse the enemy.

One section of the exhibit is devoted to an explanation of the principles of concealment set forth by Abbott Thayer, an American artist, whose book published in 1909 is still the most important reference book on this subject. Of these principles, the four basic ones are: (1) the resemblance between the object and the background, (2) obliterative shading, (3) the methods of blurring the outline by using a disruptive pattern and (4) eliminating shadows by structural adaptations. The markings on a jaguar, zebra and giraffe, which make them well suited to their environment, are examples of the first principle. The outlines of their bodies are completely lost in the

dense foliage when they are more than eight or ten feet away.

Another angle of this immense camouflage problem is the importance of perception. Black and white drawings show how line and contour fool us even more than color.

It is too late to reconstruct our modern industrial centers and to tear up our super-highways, but every effort must be made to distort these production landmarks which serve as a guide to enemy aircraft.

EMILY DUANE WALLACE

MATHEMATICS RETURNING—AT LEAST FOR A TIME

ONCE mathematics occupied an important place in every high-school and college curriculum. Now it has largely disappeared, having been displaced by the great number of other sciences and by non-scientific subjects which are now demanding attention. It has been going the way the classical languages have gone, and hardly more slowly. First, college degrees were given upon the completion of courses having no required work in mathematics at all. Then the secondary schools began waiving their mathematics requirements for graduation. Emphasis was placed upon subjects having "practical value" for solving the problems young boys and girls, young men and women, would have to meet upon their graduation from schools and colleges.

This change in curriculum was not made on the basis of experiments to determine the relative values of various disciplines in education. It was not made on the basis of elaborate and coherent theories about the relative usefulness in education of various subjects, such as those which Herbert Spencer developed three generations ago. Mathematics was simply crowded out. The subjects available for college credits increased ten-fold while the length of the college course remained fixed and the prerequisites for entering college were not doubled. At the University of Chicago, as long as twenty-five years ago, there were more than 600 majors of work available for undergraduate credits, while only thirty-six were required for

graduation. They were subject, however, to the requirement that they should include one or more sequences in one field or in closely related fields.

Naturally as the new subjects and courses made headway, the old were partially or entirely displaced for the many who in earlier days had struggled with the perplexities of algebra, geometry and trigonometry, but not of course for a relatively few specialists who increased greatly in absolute number and went immeasurably beyond their predecessors. Ignorance of mathematical subjects was not a reason for apology, but more often one for boasting. Not only were the technicalities of algebra and geometry beyond the horizons of students graduating from high schools and colleges, but so also were the elements of arithmetic and arithmetical processes.

Recognition of the conditions that had developed is now forced by the demands for young men in the Engineer Corps of the Army and the Navy, in the Air Corps, in the Signal Corps and in the Artillery. It is being found that a large fraction of those who are examined for these services are wholly unfamiliar with elementary geometric relations and even can not perform correctly simple arithmetical computations. This mechanized war demands skills in these fields, not on the part of a few leaders, but on the part of hundreds of thousands.

Consider the Air Corps of the Army and Navy. Every pilot and navigator and bombardier must be proficient in arithmetic and geometry. In fact, these

are the elementary prerequisites for an understanding of the serious technical problems that must be mastered before a cadet is qualified to become a member of the combat crew of a plane. In the early days of the war it was often stated with good reason that it takes two years to make an airplane pilot or navigator or bombardier. But two years are not available. Tens of thousands of planes are scheduled for production in the next few months and more than one hundred thousand next year. Since the minimum average crew of combat planes includes three men, hundreds of thousands of young men must now study mathematics—elementary mathematics, it is true, but mathematics much beyond what has been taught on any considerable scale in the recent past. They must also master related subjects in physics and astronomy. The situation would be serious even if there were not large demands for similarly trained men in several other branches of the armed services and in industrial laboratories.

The ways are very numerous in which the war is changing our modes of living,

our habits of thought and even our ideals. The place of mathematics in education is simply one of them that happens to be of great importance at present. Mathematics must be studied now by hundreds of thousands, but whether it should regain and retain its former place in school curricula after the close of the war is a question that can be answered, if at all, only after thorough investigation and, if possible, experimentation. The same can probably be justly said of all the other subjects in our educational curricula and of the collateral school activities that take up a considerable fraction of students' time. Perhaps these extra-curricular activities are the most important part of education. Perhaps scholars have become too critical of everything except current ideas and look too often with cynicism on ideals our predecessors revered. Perhaps there is a lesson in the fact that when old graduates get together they almost invariably follow their praises of the professor who benefited them most with the statement that they learned very little about the subject he taught. F. R. MOULTON

THE SCIENTIFIC MONTHLY

JUNE, 1942

NATURAL HISTORY OF TERMITES

I. THEIR GEOGRAPHY

By Dr. VICTOR W. VON HAGEN

FELLOW OF THE ZOOLOGICAL SOCIETY OF LONDON; SANTA MONICA, CALIFORNIA

ALTHOUGH termites are very plastic in their adaptability to changing environment, only one species of termite (*Reticulitermes*) has world-wide distribution and lives in temperate zones having severe winters. Of the eighteen hundred known species of termites, only a fraction of them live in temperate zones; the rest are confined to a relatively narrow ecological zone in the earth's warmest regions.

The geographical distribution of termites is determined, to a greater part, by the minimum and maximum of temperature, for moisture and temperature are inseparable as environmental factors in termites. The United States has, for example, over fifty-eight species of termites, the greatest of any temperate region—a fauna that extends as far north as Canada and involves all but one of the forty-eight states in its depredations. This arises mainly because of the proximity of the United States to the rich Mexican termite fauna and still another factor: the tendency in North America toward central heating. Man here provides conveniently grouped, comfortably heated homes for wood-eating insects who would ordinarily succumb or withdraw when the temperature is less than fifty degrees.

Europe harbors two indigenous species and they have caused serious damage.

All the southern provinces of France are involved, as well as Spain, Italy, Sicily. The British Isles are singularly free from the termite, as they are just below the mean annual isotherm of 50 degrees, which closely approximates the distribution of termites, which seem to succumb to any temperatures below this isothermal norm.

The reason for this geographical restriction is that termites have only a relatively thin and delicate integument, and lack the heavily chitinized exoskeleton of other insects and so are subject to bodily evaporation. Temperature—and thus the geographic distribution of termites—bears a relation to their sheltered life. Because of this readiness to evaporation they have become confined to structures which have more or less controlled temperatures. Even within their burrowings, the vulnerability of the termite to any temperature below fifty degrees is the deciding factor in their distribution. So, spectacular newspaper stories to the contrary, there is no sudden invasion of termites from the tropics, merely the adjustment of certain species present for millions of years to the changed environment brought about by man.

Confined to a narrow ecological range as they are, held by their frailty to their crypts, there is a natural limitation in



THE END OF A TERMITE ZONE IN THE HUMID SECTION OF ECUADOR
SOUTH OF THIS POINT THE LAND BECOMES A DESERT. THE AUTHOR IS EXAMINING THE LAST NEST,
WHICH IS ATTACHED TO A MANGROVE OVERHANGING A SALT-WATER ESTUARY.

the termites' extreme diversification: there are only one hundred and thirty genera and seventeen hundred and eighty-five described species which, alongside of other orders of insects, is startlingly small. But what the termites lack in generic diversity, however, they make up in quantity, for they are of the most numerous insects in the hot lands.

TERMITE ARCHITECTURE

As to be expected, the greatest florescence of termites is in the tropics. In Katanga, a Province of Belgian Congo, in North Rhodesia, termite mounds reach the incredible height of eight meters. In Africa, which has over five hundred species of termites, there are carton-building termites that construct immense nests in trees, other species that construct nests like giant mushrooms, and desert-dwelling termites that cover the scarce vegetation on the veldts and reduce it to hollow shells. There is another group of mound-building termites which cultivate fungus in the center of their mounds.¹

The mounds of the termites are, perhaps, the most conspicuous feature of the African landscape. They are also on the savannahs of Paraguay and in the jungles of the Amazon, where, however, due to the frequency of floods, most of the termite nests are arborelous, or tree-dwelling types.

Australia has the distinction of having the tallest nests, termite spires that reach over thirty feet in height, and equally famous for their meridian tendency. Nests are found scattered over the thickly wooded sections, as well as the open country of Australia. The most curious feature of their architecture is their orientation to the direct rays of the

¹ These fungus-growers represent the most highly specialized members of the termite order, Isoptera. It is curious to remark that while there are fungus-growing ants in the Neotropics (New World), there are no fungus-growing termites, while in Africa and Indo-Malay it is quite the reverse.



A TERMITE NEST IN HONDURAS
LARGE CARTON NESTS PERCHED IN THE CROTCH
OF LIVING TREES ARE A FAMILIAR SIGHT IN THE
WARM AND HUMID TROPICS.



H. L. Schantz
MUSHROOM-SHAPED TERMITE NESTS
IN THE HUMID JUNGLES OF THE AFRICAN CONGO
THE *Mirotermes* CONSTRUCTS ITS NEST WITH A
CAP SHAPED LIKE A MUSHROOM, THE ONLY PUR-
POSE OF WHICH IS TO SHED WATER.



NATIVES OF HONDURAS CARRY IN CARTON NESTS OF *NASUTITERMES* THESE SERVED AS LIVING LABORATORIES IN EXPERIMENTS ON TERMITE REACTIONS TO LIGHT.



TERMITE MOUNDS OF CENTRAL AFRICA OFTEN COVER AN ACRE *H. L. Schents*
MILLIONS UPON MILLIONS OF INDIVIDUAL TERMITES MAKE UP SUCH A TERMITARY. THE NESTS OF
AFRICA ARE MATCHED IN SIZE BY THOSE OF AUSTRALIA AND PANAMA.

sun. For a quasi-desert country, the termite population of Australia is very high, having over one hundred and fifty species. But whether the termites are found in Indo-Malaya, Africa or America, they all fulfil one important function: the breaking down of decayed cellulose into its basic chemical elements, which are returned to the soil. In fact, Drummond, the English naturalist, pointed out long ago that the termite in the tropics performs an important function analogous to that of the earthworm in temperate regions, but on a greater scale. Termites feeding wholly on dead vegetable matter conspire with the bacteria and humidity in order to accelerate the disintegration of all the lifeless wood which is converted into a humus and which, in turn, is utilized by the growing vegetation. It is thus that the termite fits into the teleological "scheme of things."

Dwellings of the mound-building termites can only be thoroughly understood if one takes into consideration the miniscule insect that builds them, and one can only realize their immensity if one compares them with the achievements of man in physical relation to his own structures. If man built his buildings in proportion to those made by the termites, his tallest structure would be over 11,000 feet in height, about twice the height of the Schneekoppe in Germany or twenty times as high as the Washington Monument. If we take the average worker-termite as five millimeters in length, its buildings are 2,500 times the length of a single worker!

The structures of the termite of Africa have even given a hint to man for some new types of defense structures against air attack. The architectural features of the termite have even been suggested in the future planning of cities against strafing from the air. Each block in great cities would have a glorified termitarianium, a mushroom-shaped building standing in a wide court. It would have



THE ENEMY OF WOOD EVERYWHERE ARE THESE DESTROYERS, THE *Kalotermes*. WHITE, SOFTBODIED AND ARMED WITH SHARP DENTATED MANDIBLES, THE WORKERS CAN GO THROUGH THE HARDEST WOOD. THEY NEED NO GROUND CONTACT, AND THEIR COLONIES ARE USUALLY SMALL.



A TERMITE NEST OF THE AMAZON THE IMMENSE SAVANNAHS BACK OF THE RIVERS OF THE AMAZON ARE SPOTTED WITH HILLOCKS WHICH HARBOR HUNDREDS OF DIFFERENT SPECIES OF TERMITES. MAN, BIRD AND BEAST EAT THE WINGED SPECIES IN THE RAINY SEASON.

a circular tower of some height, with a fusiform top shaped like the cap of a giant termitary. The thickly made, windowless structure would have a series of rooms, each self-containing and, like the termite's realm, a sort of fortress.

But if the termites have shown man some factors in architecture, it is only inadvertently, for the real purpose of the nests is not only for defense, but they are also built thus because termites are soft-bodied insects, liable to evaporation. That, in addition to the ceaseless deprecations by ants, has elaborated the termite fortresses. As the nests are airtight, heat is regulated so that the diurnal temperature in them varies only nine degrees; and so, to a certain degree, they control their environment, for on the outside the temperature may vary as much as twenty-five degrees. By this control, the correct amount of humidity is kept constant to forestall evaporation. However, there are some species, like the *Macrotermes* of Malaya, which, when the soil is wetted and the atmosphere thoroughly saturated, create conditions which allow them to take to the open. This the *Macrotermes* does in long, hurrying columns traveling between rows of soldier termites, always on guard against the attack of ants.

The termite "society" is a very old one. The habits of building its large termitaries that spot the landscapes of Panama, Paraguay, Africa and Australia are so ancient that a whole genera of animals, the Edentata, the ant-eaters, have become specialized in their evolution solely for the eating of insects, particularly termites. The aardvaark of Africa, the scaly anteater of Indo-Malaya, the long-snouted giant ant-eater of Central and South America, have developed scythe-like claws in order to rip open these strong termitaries, and a long tongue, covered with a viscous substance to pull the hapless termites into its toothless jaws. All this implies for the termite a very ancient lineage, to have

caused a group of mammals to become highly specialized just in order to rip open and feed upon the inhabitants of its steracoreous republic.

FOSSIL TERMITES

It is now generally accepted that termites began to evolve sometime during the Age of Reptiles. While the fossil records are by no means complete, it is rather certain that the ancestors of our present insect fauna had a long and varied history before the last part of the Carboniferous period. The termite, one of the more primitive of insects, rose from what is generally believed to have been the earliest form of insect life, the cockroach. From it, some believe, many insect forms have stemmed. The termites developed from a form of this cockroach, the *Proto-blattoids*, perfecting, after long evolution, a complex social organization.

Fossil termites are very well represented in the ambers from the Baltic, for the viscous resin from the Tertiary conifers caught some swarming termites and entombed them in it. Other termites, then distributed over a belt of modified tropical clime, fell into the soft slime of prehistoric mud deposits—the accumulating debris of volcanic flows—and when this hardened into rock, the winged termites were preserved for posterity. Thanks to these varied methods of preservation, we have a very excellent idea of the development of the ancestors of the present-day termites. Yet the fossils tell us little or nothing about the evolution of the social state among the termites, for the fossil termites are similar in many respects to those found in the same regions of the earth to-day. It is therefore quite inescapable that the termite's social organization was perfected many millions of years ago, and that the multiple species that infest the world to-day have only perfected minor or insignificant changes during all these centuries.

A fossil termite, *Mastotermes*, is found,



THE FIRST ILLUSTRATION OF TERMITE NESTS

SMEATHMAN'S DRAWING OF 1781 ILLUSTRATES NESTS OF THE MUSHROOM-GROWING TERMITE, *Termes bellicosus*, OF AFRICA. NOTE THAT THE ARTIST HAS ATTEMPTED TO SHOW THE HEIGHT OF THE NESTS AS WELL AS THEIR DURABILITY BY DRAWING MEN AND CATTLE STANDING UPON THEM. SMEATHMAN'S REPORT ON THE TERMITES OF AFRICA, WHICH WAS GIVEN BEFORE THE ROYAL SOCIETY, WAS ONE OF THE FIRST OBSERVATIONS ON THESE REMARKABLE INSECT SOCIETIES.



AN ABANDONED TERTIARY IN AFRICA BECOMES A BRICK-KILN

MAN UTILIZES THE RESIDUE OF TERMITE ARCHITECTURE. BROKEN AND POWDERED, THE IMMENSE TERMITE MOUNDS CAN BE USED AS CEMENT WHEN MIXED WITH WATER. SOME INGENIOUS MAN HAS HOLLOWED OUT THIS TERTIARY NEAR ELIZABETHVILLE AND TRANSFORMED IT INTO A BRICK-KILN. GOLF COURSES ARE BUILT ABOUT THEM IN AFRICA, WHERE THEY SERVE AS "BUNKERS."

for example, in the Eocene and Upper Oligocene of England, which shows the same generic differentiation as a species of the genera found to-day in Australia. A study of the structure of the living representative of *Mastotermes* by the renowned Froggatt of Australia showed a combination of characters peculiar to cockroaches and characters that are common to termites so startling that the late Dr. Wheeler facetiously remarked that this *Mastotermes* has the same interest for the termitologists that the *Pithecanthropus erectus* has for the anthropologists!

There is yet to be revealed, from the geologic records, the rise of the social sphere among termites. Cockroaches, it is true, are quasi-social; but they are not differentiated into castes, nor does the life of the parent cockroach extend beyond the life of the developing insect, which would be necessary to reveal those



TERMITE DAMAGE IN THE TROPICS
ALTHOUGH THIS SEAT HAS BEEN IN CONSTANT USE AND IS MOVED ABOUT, THE TERMITES HAVE WORKED WITHIN THE CONFINES OF THE WOOD AND WILL GRADUALLY UNDERMINE EVERY INCH OF IT. THIS IS THE WORK OF THE GENUS *Cryptotermes*, WHICH NEEDS NO MOISTURE CONTACT.



TUNNELS PROTECT THE TERMITE
THE WHITE-BODIED *Heterotermes* OF CENTRAL AMERICA CONSTRUCTS TUBES IN WHICH TO TRAVEL TO THE JOISTS IT IS ATTACKING AS IT NEEDS MOISTURE CONTACT WITH THE GROUND.

extraordinary manifestations of organic cooperativeness that leads to the social form in insects. There are modern species of the cockroach that eat cellulose, the *Cryptocercus* in particular. Cockroaches also hollow out places for nesting and exhibit negative phototropic habits which makes them, like the termites, flee from light. None of the modern cockroaches, however, show any tendency toward the perfection of the social forms. No insect society can be successful without division of labor or a correlated specialization of structure and behavior. There is every reason to believe that the early predilection for wood by the primitive termites was not brought about wholly by choice, but rather by the depredations on the soft-bodied prototermites by the rapacity of ants which, though of a hymenopterous ancestry, were already present during the early developing periods of the termites.

Ants everywhere eagerly prey on termites. There are ants whose whole habit-cycle is built upon systematic attacks on the dwellings of termites, and species of



TERMITE NEST IN MEXICO

A COMMON FEATURE OF THE PACIFIC LITTORAL REGION OF MEXICO ARE THESE ARBOREAL NESTS OF THE *Nasutitermes*. EVEN THE AZTECS HAD A NAME FOR THEM—*tachinastl*.

ants that are conditioned in behavior to meet the curious defense mechanisms of the termite. In fact, the defensive factors of the termites have been perfected only for their one real enemy—the ant; their manner of living in closed burrows and the technique of the soldiers of throwing off volatile liquids in the form of gases or viscous latex streams are defences only against the systematic depredations of ants, so that, doubtlessly, the ever-present menace of ants has led to the evolution and perfection of the termite's cryptobiotic habits.

Almost the whole of our knowledge of the behavior of the termite is through its response to the abnormal. One must lay bare their burrows in wood, the hypogeums of the termitary, before the termite organization can be observed in flight or in performing tasks that it does only in abnormal emergencies. In a sense, some of its curious habits lead to its name.

Linnaeus, the Swedish systematist, named the termite after "Terma," Greek

for the goal, the end of life. The name of the insect which we now call the termite was confused with the deathwatch beetle, a form of the Anobiidae, which lives in furniture and is responsible for the worm-holes that perforate it. This beetle has a curious sexual aberration of knocking its head against the side of its burrowings, which results in a curious ticking noise. To the superstitious European peasantry, this was an evil augury of approaching death to some one in the household—hence its name, deathwatch beetle.

The larva of that beetle, a small soft-bodied white insect living in its cryptic burrows, was mistaken for the termite as it has the same soft, white body as the insect to which Linnaeus gave the name "termite." "Terma"—the end or goal of life—is a ridiculous name for the ter-

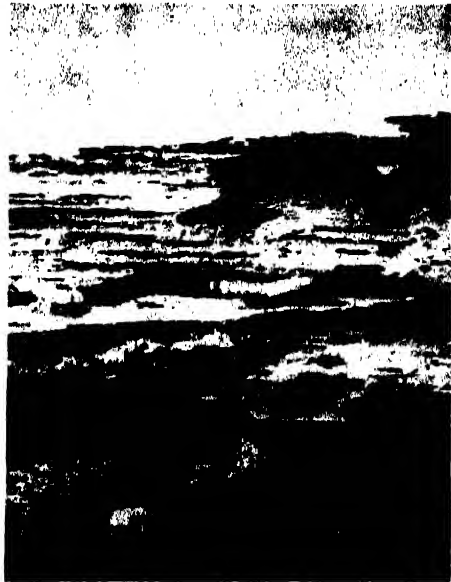

TERMITE GALLERIES WORK HAVOC WITH THEIR BORINGS PROTECTED BY THE STRONG HEAD OF THE SOLDIER, A COLONY OF THESE *Kalotermes* MAY REMAIN ALMOST "IMMORTAL," SINCE IN ADDITION TO THE FLYING REPRODUCTIVES THAT FORM NEW COLONIES, "BUDDING" TAKES PLACE WITHIN THE COLONY AS WELL.



H. L. Schantz

TERMITES CONSUME LIVING TREES
 TERMITES ARE HERE DESTROYING WHAT WAS ONCE
 A SOUND EUCALYPTUS TREE IN AFRICA. THE
 RATE OF TERMITE DESTRUCTION OF LIVING PLANTS
 IN THE TROPICS IS VERY HIGH.

mite, as the queen termites are known to lay, during their life span, millions of eggs; it is certainly an absurd name-symbol for such extravagant fertility.

The admirable Smeathman, whose letter to the Royal Society in 1781 constitutes the first scientific report on the termites, described the gigantic termite structures in Africa. This information was received with incredulity by his colleagues of the eighteenth century. Africa was known to contain indescribable wonders, but Smeathman's report on insects that built enormous structures as much as 2,500 times the size of the workers, was a bit fantastic. Entomology, then, was suspect; it was, as the late Dr. Wheeler remarked, then regarded as a "form of concupisence, a *libido sciendi*, a *libido oculorum*"—an avertible peccadillo and a subtle and deadly tempta-

tion—perhaps the African sun had upset the critical faculty of Smeathman.

Travelers into Africa soon found that Smeathman did not exaggerate the industry, the social organization and, what is more, that he did not overestimate the depredations of these insects. Nor was this insectivorous destruction confined to Africa alone. The Spaniards in the New World found themselves at grips with this insect too. Houses were eaten away, the wooden base of their ordnance attacked and libraries destroyed. So consistent was the termite's love of literature, that in 1811 the famed German traveller Baron von Humboldt attributed the backwardness of the Latin Americans to the fact that they were unable to accumulate libraries, as the termites destroyed them as fast as they could be assembled.

The termite even caused a minor crisis in the none-too-stable government of King Carlos III of Spain. He had sent via Panama, toward the end of the eighteenth century, a shipment of gun-flints destined for Peru. The Viceroy in Lima patiently waited the arrival of the gun-flints and when they did not arrive, complained to the King's Council for this oversight. When the Governor of Panama was approached for an explanation, this administrator replied that the "commejens (the Spanish name for the termite) had destroyed all the crates and that the flints were lost in the dust. The King's Counselers, who did not know what a "commejen" was, issued a royal decree—still extant in the Library at Quito in Ecuador—demanding that the governor of Panama make a summary judgement on this *commejen*, compile a list of his grievous crimes against the state, and send him back under suitable guard to Spain, "Where he will be judged according to the result of his criminality."

(To be continued)

SWORDFISHING WITH THE HARPOON IN NEW ENGLAND WATERS. II

By Dr. E. W. GUDGER

HONORARY ASSOCIATE IN ICHTHYOLOGY, AMERICAN MUSEUM OF NATURAL HISTORY

Dories "Punched."—In the first stage of the harpooning game, when the fish has been struck from the pulpit and swims away, he is tethered to the vessel and in by far the greater number of cases is on the defensive—though he sometimes does take the offensive to the hurt of the boat. Later when *Xiphias* has supposedly tired himself out dragging six hundred feet of sagging line and the attached keg about, one or two men are sent out in a dory to pull up alongside him and kill him by lance-thrusts in the gills. This may be all right for a grizzled old-timer, but when such an apparition emerges from the deep, a greenhorn doryman might well have qualms at the sight of the staring eyes and the massive sword.

At this juncture, however, the fish, "not very much resigned to die" (as it is put by the 1571 chronicler, quoted elsewhere for the Strait of Messina) not infrequently goes on the offensive, takes charge of the proceedings and launches himself against the dory to the great peril of the fishermen.

Innumerable attacks on dories must have occurred since swordfishing first began off New England nearly one hundred years ago, and of these but a small number have been recorded. Of this number I will quote here but a few, choosing those which are decidedly dangerous and from which if possible illustrations are at hand. Ordinarily the boat is "punched" through the bottom or side, but I have one unusual record where the sword went completely across the boat, piercing both sides.

In a case recorded by F. G. Hinsdale,

a swordfish had been harpooned and, after it had supposedly tired itself out, Hinsdale and a fisherman went out to haul it in. When the line was nearly all in, it suddenly went slack. Thinking that the fish was gone:

"Lost him," said Jimmy, in disgust, and the next second a thrill went through the dory as if it had been struck a sharp blow with a sledge hammer. There in the coil [of rope] just ahead of Jimmy's feet was some thirty inches of sword punched clean through the bottom. "Well, what do you know about that?" queried Jimmy with a grin, as, wrenching the sword backward and forward, he snapped it off short at the planking. Using the roller as a mallet, he drove the stub of the snout out of the puncture, through which the water welled like a spring until stopped with one of the canvas nippers worn to protect the hands while hunting. The fish, already exhausted and stunned by the impact, offered no further resistance and was readily taken.

This is called "getting plugged." . . . Up to this time I have never fully answered Jimmy's query as to "what I know about it," but as I had been seated on the flooring astern, I know I am at least grateful that the fish elected to strike just where he did.

Now comes an account showing pictorially just what *Xiphias* can do with his broadsword. It happened to Mr. G. M. Phelps, Jr., who was out swordfishing off Montauk Point, Long Island, in August, 1936. A fish had been harpooned in normal fashion and line and keg had been thrown overboard. When it was thought that the fish had thoroughly tired itself, Mr. Phelps and one of the fishermen went out in a skiff to pick up the keg and bring the fish aboard. However *Xiphias* was by no means exhausted. When it saw the boat floating on the surface about fifteen feet away, it must have taken it for an enemy

or an object in some way allied to its present hurt. At any rate it charged the boat and drove its sword through a three-quarter-inch hard pine board in the bottom of it—fortunately without striking either of the men.

Then the fish in a frenzy lashed out and, after shaking the boat for some seconds and nearly upsetting it, broke off its sword, leaving the point extending diagonally through the splintered plank a distance of eighteen inches into the skiff. Seemingly exhausted by its efforts, and apparently subdued by the loss of its weapon, the fish allowed itself to be hauled aboard. The sword entered the board from the outside and split it longi-

tudinally. The total length of the broken-off sword is 25.5 inches. The skiff, rendered useless by this mishap, had to have the old plank taken out and a new one put in.

If the sword penetrates a board parallel to the grain of the wood and splinters it, it may cause a considerable leak. Many leaking swordfishing vessels must have been struck like these two—with the grain of the wood—as was the little "sworder" "Redhot" of New Bedford in 1871.

An interesting attack took place on Georges Bank on June 24, 1937. It was described in lively fashion as follows, in the Boston Herald of June 28:



R. I. Nesmith

**AN APPARITION EMERGES FROM THE DEEP
THE SIGHT OF THE LONG, DOUBLE-EDGED SWORD AND THE GREAT STARING EYE OF XIPHIAS WOULD
SURELY EXCITE QUALMS IN AN INEXPERIENCED DORYMAN.**

The swordfish was harpooned from the pulpit of the schooner "Andrew and Rosalie" . . . southeast of Block Island, June 24, and Isaac Boudreau went out in a dory to play it. For an hour and a half the big fish towed the little craft about in various directions, alternately leaping from the sea and sounding to great depths, and finally when the dory was three miles from the mother vessel, the fish dived and came up directly beneath the boat, piercing the bottom with its sword. Momentarily expecting the boat to be shattered by the struggles of the heavy fish, Boudreau signalled the schooner for aid. When the swordfish made no further movement, he realized that its attack on the dory had been its final effort.

Captain James Abbott of the "Andrew and Rosalie" confirmed this account and added further details:

Isaac was out alone, hauling in the keg and line, and when the fish got near the dory it suddenly turned toward it and rammed its sword through the planking of the bottom, the sword sticking through about a foot. Isaac, rather scared, had perched himself on the rear thwart of the dory and so escaped any possible injury. The sword broke off and the fish was soon captured. After the men unloaded their fish they cut the sword off, *i.e.*, the parts projecting inside and out, and the rest of it still remains in the dory. This natural plug saved them the expense of putting in a new plank.

This sword evidently penetrated the plank squarely, or at right angle to the grain of the board and hence did not open any crack. Thus the boat did not take in water. Boudreau's getting up on the thwart out of the way of the sword is standard procedure when it is seen that the fish is going to charge.

On July 10, 1937, one of the dories of the "Adelaide T." was "punched" off the northeastern end of Long Island. From Mr. John Maxson, the doryman concerned, I have the following vivid account of the encounter with his 350-pound Xiphias. Incidentally, the latter part of his story gives evidence of the enormous vitality of this stout-hearted fish.

We harpooned the fish off Easthampton, Long Island. But in the meantime we landed a very big fish which required much hauling and tugging for about an hour altogether. This took

most of the pep out of me, so when we sighted another one about five minutes later, I vowed that this one was coming in fast—which he did to my regret.

I hauled on the line until he was about ten feet from me, when I let him tow me. This he did for about two minutes, when, without any warning, he turned and fastened his sword all the way into the dory at the water's edge. So I hauled in all the slack I could and tried to get his tail out of water, but he was plenty mad and made quite a fuss. So I signalled the big boat to come alongside, since in the meantime the dory was filling rapidly.

They came up and put a small steel cable around his tail and started to haul him in. However, he had other ideas and put up quite a fight but the power from a 60 h.p. Diesel engine was too much for him. Incidentally the reason for the great struggle was the fact that when we started to pull him aboard, we broke off his sword.

To haul such a great fish aboard a schooner, a loop of line is taken around the "small" of the tail and the fish is hoisted and swung aboard, sometimes by hand power but generally by a gasoline or Diesel engine. The next step in handling the fish will be described later.

Two accounts of swordfish attacks on dories during the season of 1938 have come to me through the assiduity of Mr. F. E. Firth, biological collector at Boston for the U. S. Bureau of Fisheries. One of these concerns not only the attack on a dory but the wounding of the doryman, and it will be found at the end of the next succeeding section. The other will be considered here.

Late in July, the schooner "Nyoda," Howard Tobey, owner and captain, was fishing off the northern end of Georges Bank. A swordfish was struck in the back and line and keg were thrown overboard. Presently Alphonse White was sent out to haul in the fish. It came along quietly at first, but as it got closer to the dory it put up quite a fight. Next it started driving straight at the boat, as though following the line. Then there was a thud and a splintering sound as the sword hit the dory and appeared through the planking and through a brace board on the inside.

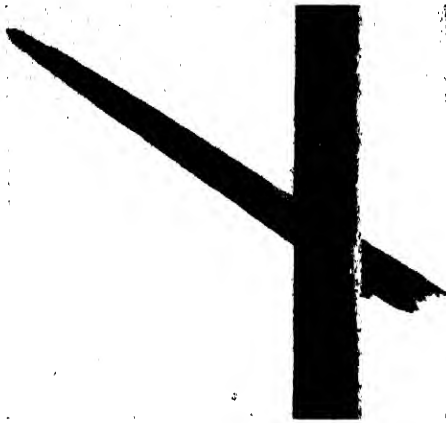

G. M. Phelps, Jr.

SPLINTERED BOARD

A HEART-PINE BOARD FROM THE BOTTOM OF A DORY WHICH WAS SPLINTERED BY A SWORDFISH.

There are two things of particular interest in this account. The first is that the fish was struck not in the head but in the back, yet it went on the warpath. This agrees with Mr. Hand's dictum that in his judgment it makes little difference where a fish is struck, that one struck not in the head but in the back will sometimes, under conditions not well understood, attack a boat. The other is that this fish followed the line back to the dory and to the man pulling on the line.

Men Hurt in Attacks on Dories.—That swordfishing is a dangerous occupation has long been known. And with the multiplication of accounts of attacks on vessels as set out above, the reader has been wondering if the attacks on the bows (and forecastles) of swordfishes have not resulted in hurts, if not fatalities. However, since such attacks are made almost entirely in the daytime when the men are all on deck, no forecastle fatalities have been recorded. On the other hand, attacks on dories are only made when these boats have fishermen in them. There have been many narrow escapes from such attacks—some of which have been narrated above. But not always have the fishermen come off unscathed.

Earliest of all such cases, old Polybius in 100 B.C. recorded that swordfishing was a dangerous sport in his day, not infrequently resulting in wounds to the fishermen. Thus, as quoted by Strabo, he says: "It sometimes happens that the rower is wounded, even through the boat, and such is the size of the sword with which the galeote [swordfish] is armed, such the strength of the fish . . . that [in danger] it is not surpassed by the chase of the wild boar." None of the other classical writers, not even Oppian, who discourses at such length about Xiphias as an ocean gladiator, mentions the danger to the fishermen, although they do refer to the assaulted boats.

Coming now to our own waters, Captain Benjamin Ashby stated years ago that one of his crew was once wounded by the assault of a swordfish. The sword came through an oak board in the bottom of a boat on which a man was standing and penetrated about two inches in his naked heel.

Dr. C. H. Townsend, of the New York Aquarium, was once on a swordfish hunt off Block Island, when he found one of the crew of another swordfish vessel being taken ashore with a wounded leg. A fish had been struck and when the man went out to pick up the buoy and bring in the fish, Xiphias charged and wounded both the boat and the man.

Bigelow and Welsh, in studying Xiphias in the Gulf of Maine, heard of many dories which had been rammed without hurt to the fishermen. But they add: "We have . . . known several fishermen who have been wounded in the leg [in such assaults]."

More recently (July 5, 1937) Captain Alfred Cyr went out in a dory to retrieve a swordfish harpooned off Block Island. The fish charged the dory, ran its sword through it and wounded Captain Cyr slightly in the chest.

Another like mishap occurred in the Block Island region on the same day.

Mr. Paul C. Nicholson of Providence, R. I., was out swordfishing from his motor-sailer "Onza," when a swordfish was located. Put "onto the fish," Mr. Nicholson harpooned it—by a queer fluke—through the keel alongside the left base of the tail, as was found when the fish was brought in later. The buoy was thrown out and presently Mr. Nicholson and Captain Harry L. Smith went out to gather in Xiphias. But the fish, being merely tethered (practically not hurt), swam in wide circles offering much resistance to the "hauling in" efforts of the Captain, who remarked—"He's acting bad." But he had only begun, for suddenly he sounded, then coming up he rammed the boat from below. Just as Mr. Nicholson looked down, 18 inches of sword came through the bottom of the dory and the point cut a gash 6 or 8 inches long and about a fourth of an inch deep on the outside of the right calf. This was a narrow escape, and Mr. Nicholson writes "Had my foot been an inch or more to the right, I would probably have lost it."

The blow split a board in the boat's bottom, and with difficulty she was kept afloat until the "Onza" came up and rescued the men. The tethered fish resisted strenuously all efforts to bring him to the ship, and only after a conflict of two and a half hours was he got aboard.

In answer to a letter, Captain Smith writes that in 40 years' swordfishing he has had many dories punched. "We do not pay much attention to getting punched as it is a common thing to us fishermen." However, he tells of one bad accident. The sword came through the bottom of the boat just where a man was sitting and went through his thigh. He was taken to a hospital and fortunately made a successful recovery.

One account of a fisherman hurt in 1938 has come to me. This was recorded in the *Boston Post* of August 3rd. The "Evelyn G. Sears," Antoine Sears, mas-

ter, was swordfishing on August first about one hundred and sixty-five miles east of Boston. A fish was harpooned in the head and a doryman, Frank Ferrara, was sent out to bring him in. When the dory was about fifty yards from the schooner, the maddened fish turned toward the boat and in a wild dash drove its sword through the side of the dory and then into the calf of the man's left leg, pinning him down until help arrived. When Ferrara was got aboard the schooner and it was found how badly hurt he was, Captain Sears called off further fishing to drive hard to get the wounded man to Boston and a hospital.

Mr. Firth, to whom I am indebted for these data, examined the fish and found that it weighed five hundred and five pounds "dressed"—i.e., with head, tail and fins cut off and viscera out. This was a large and powerful fish. Its sword was, unfortunately, not measured but it is reported as rather disproportionately small for so heavy a fish.



Boston Herald
SWORD AND NEAR VICTIM
 IRAAC BOUDREAU AND A SWORD LIKE THAT WHICH
 NEARLY FINISHED HIM WHEN HIS DORY WAS
 RAMMED ON GEORGE'S BANK, JUNE 24, 1937.

When a swordfish is brought up to the schooner, a loop is thrown around the tail, and it is hoisted aboard. But, if the fish is still alive, all danger is not yet over. So in order to prevent accidents it is necessary to cut off its sword. Then the fish is "dressed" before being lowered into the hold for "icing down." That there is a particular reason for depriving a not-yet-dead swordfish of its weapon is found in the following incident.

Mr. J. C. Zauner, who spent some weeks on a sworder, tells me that one day when a live fish was brought aboard, before its sword could be secured, the fish slashed out in a death flurry and with its weapon struck the captain on the leg. The sword sheared through the man's clothing and inflicted a five-inch cut in his leg.

This indicates the great vitality of this powerful fish. On this point Ralph Bandini writes (1933) more fully as follows: "Broadbill have not alone tremendous strength but unbelievable vitality as well. I remember one fish that was hooked and landed off Point Vincente [California]. He was loaded onto the deck of a launch and brought back to Avalon, two hours and a half away. When he was hoisted onto the pleasure pier there he came to life, wrecked the standard upon which he was hung and carried away a piece of the railing."

Men Killed in Attacks on Dories.—From the accounts of dorics "punched" it is to be expected that a fisherman in a dory or skiff will occasionally lose his life when a swordfish makes its dangerous assault. Although a small number of fatal accidents due to swordfish are on record, only two such fatalities to New England fishermen in their dorics have been found in an extensive search.

Early on August 9, 1886, the little schooner "Venus" sailed out of Lanesville, Mass., with Captain F. D. Langsford and a crew of three men. Here is what

happened when, instead of harpooning a swordfish from the bowsprit of the schooner, it was done from the dory. This is the case of dory-fishing referred to previously.

About 11 A.M. . . . a fish was seen. The captain, with one man, taking a dory, gave chase and soon harpooned the fish, throwing over a buoy with line attached to the harpoon, after which the fish was left and they returned to the vessel for dinner. About an hour later, the captain with one man took his dory and went out to secure the fish. Picking up the buoy, Captain Langsford took hold of the line, pulling his boat toward the swordfish, which was quite large and not badly wounded. The line was taut as the boat slowly neared the fish, which the captain intended to lance and thus kill it.

When near the fish, but too far away to reach it with the lance, it quickly turned and rushed at and under the boat, thrusting its sword up and through the bottom . . . 23 inches. As the fish turned and rushed toward the boat, the line was suddenly slacked, causing the captain [who was hauling on it] to fall over on his back; and while he was in the act of rising, the sword came piercing through the boat and into his body. At this time another swordfish was in sight nearby, and the captain, excited and anxious to secure both, raised himself up, not knowing that he was wounded. Seeing the sword, he seized it, exclaiming, "We've got *him*, anyway!" He lay in the bottom of the dory, holding fast to the sword, until the vessel came alongside, while the fish, being under the boat, could not be reached. Soon the captain said, "I think that I am hurt and quite badly." When the vessel arrived, he went on board, took a few steps and fell, never rising again. . . . [and] survived the injury only about three days."

To prevent just such fatalities, Captain Harry L. Smith, of Block Island, writes that he formerly had a sheet of steel in the bottom of the boat for the boat-tender to stand on when hauling in the line. But he notes that "if the sword of a fish came through the boat and hit the piece of steel, you were likely to be knocked overboard. Once I was down off Nomans Land when a swordfish came through the dory's bottom, hit the steel plate, and knocked a man overboard and he was drowned."

The next and last account of an accident has a far happier ending and, for that reason among others, is given rather fully. It is the most extraordinary and unusual accident found in working up this history of swordfishing in New England.

A Man Dragged Overboard by a Wounded Xiphias.—There are in the literature many accounts of whale fishermen caught in harpoon lines and thus carried to their doom by diving whales. If the reader has perused any of these accounts, he must have wondered if occasionally a swordfisherman, trying to haul a fish up to his dory, has not also been pulled overboard by the superior strength of the fish, or has not had a foot caught in a coil of the retrieved line and thus been dragged overboard and down into the sea. Mr. Hand has recorded an account of a case of the latter kind.

On August 4, 1935, he was swordfishing from his yacht "Buckaroo," about thirty-five miles south of Nomans Land. A swordfish was sighted and struck, and keg and line were thrown overboard. Murray Pratt, "a giant of a man," was sent out in a dory to haul the fish in. The yacht cruised off about half a mile and presently it was noticed that the dory was floating bottom up and that a sloop nearby was making for it. The yacht ran for the dory and found two men in a skiff from the sloop supporting the limp body of Pratt, who seemed drowned, while the swordfish was threshing about nearby. Fortunately a doctor was in the party and under his direction and help artificial respiration was tried, and in about an hour and a half Pratt was sufficiently restored to be carried aboard "Buckaroo" and taken to a hospital at Vineyard Haven, where he presently recovered enough to tell the story of his experience.

Mr. Hand had ordered that every doryman take with him in his dory a bushel basket in which to coil the line as



Gloucester Chamber of Commerce

ABOARD A SCHOONER

THE SWORDFISH'S PROTESTS DO NOT AVAIL AGAINST A ROPE LOOPEd AROUND THE "SMALL" OF HIS TAIL, RUN THROUGH A BLOCK, AND WOUND AROUND THE DRUM OF A HOISTING ENGINE.

it came in, so as to prevent such an accident. On this day Pratt went off without his basket and here is his account of what followed.

I hoisted the fish up to the dory once but could not hold him. He ran off aways and then seemed to come along easily enough until I had him alongside again. Then he started for the bottom of the sea and I couldn't hold him. A turn of the line got round my ankle and over I went and down—down. I tried to kick the line free but couldn't get it off. Next I got out my knife, opened it and managed to reach down and cut the line. Then I started to swim to the surface and that's the last I remember.

One wonders that more accidents like this do not occur among the swordfishermen, since most of them simply throw the line in the bottom of the boat or at most make a loose coil of it there.

Fishing from Sport Cruisers.—The above accounts describe commercial swordfishing in the western North Atlantic, but of late years there has been developed a new style of boat for sport fishing. This is a gasoline-driven cruiser from which the sportsman either hooks or harpoons his swordfish. Here the equipment for such harpooning consists of a stout two-inch hardwood board securely bolted at its inner end to the deck and also to the stem, and further braced to the bow by iron struts or by a wire cable. At the outer end is a pulpit in which the angler or harpooner stands. The boat figured has a mast with a seat for a lookout, and a sail, in case the engine balks. However, many do not have a mast and the lookout sits in a chair secured to the cabin roof, or the harpooner acts as his own lookout. The board and pulpit are removable at will. Such boats as these are successfully used off Long Island and particularly at Montauk Point. It was from such a boat as this (Mr. Hand's "Buckaroo") that a swordfish was harpooned as described in the preceding section.

From another such cruiser, another swordfish was struck in the vicinity of Georges Bank sometime in August, 1928. Here is Captain Ira Abbott's interesting account and unique photograph of what happened.

We harpooned the fish and sent a man out in a dory to bring it alongside the yacht. As the man in the dory seemed to be having difficulty in bringing the fish to the surface, I anticipated trouble of some sort, and was standing on the deck of the yacht with my camera all ready. When I saw the flash of the fish as it broke the surface of the water, I pressed the trigger of the camera with the result as you see it in the picture. An instant later, the fish gave a savage lunge and tore a large hole in the dory, causing it to sink. We got the man aboard the yacht safely and later succeeded in capturing the fish, which weighed 350 lbs.

The photograph referred to is unique in that it is the only one ever made (so far as I know) at the very moment that

the swordfish pierced the side of the dory. In this figure is shown the right side of the stern of the dory with the sword protruding through a plank at about the water line. Below the sword is the left side of the fish's lower jaw dimly outlined in the water. Above is the line from the keg (already in the boat) leading to the shank of the harpoon under the surface of the water.

The next and last account of *Xiphias* harpooned from the pulpit of a yacht was kindly communicated by Captain James Abbott.

We were cruising around off Montauk on July 12, 1937, hunting for swordfish, when our lookout at the masthead sighted a fish right ahead. The owner of the yacht ran forward to the swordfish stand and harpooned the fish. But unfortunately the harpoon struck forward of the dorsal fin and near the head. It usually happens that when a swordfish is harpooned in or near the head, it seems to go crazy and starts looking for something to attack. This fish came to the surface after the first plunge downward and started cutting circles around the boat. We went on to it again and a second harpoon was driven into it. Still the fish would not go down and I put out in a dory to play it. I hauled on the line from the keg till I got within about twenty feet of the fish. Then it suddenly turned and like a flash drove its sword clear through the bottom of the dory. Fortunately the sword did not strike me but that was just my good luck. After striking the dory, the fish thrashed about so hard that it almost threw me overboard and did break off its sword at a point just below where it went through the bottom of the dory. We secured both sword and fish and brought them into Montauk. The sword is the one I sent you.

Commercial "sworders," as indicated above, where depths of penetration of swords in their hulls are recorded, are very heavily built to withstand the terrific poundings they receive during "blows" on the Banks. Sport cruisers, however, are built to insure pleasure fishing. In a storm on the Banks, they would go all to pieces, and if the cruiser instead of the dory were charged by a hooked or a harpooned *Xiphias*, the damage would be very serious.

THE PSYCHOLOGY OF XIPHIAS

My readers have probably for some time been querying, "Why does Xiphias assault vessels, small boats and sometimes men?" Before endeavoring to answer, it will be necessary to study the mind of the so-called ocean warrior. It will not do to accept offhand the implication as to the character of our fish found in the names given him by the ancients. The Greeks called him Xiphias and the Roman Gladius. Both names mean "sword" and both are given him because the frontal bones of his head are drawn out into a long flat sword. We moderns call him *Xiphias gladius*, thus doubly emphasizing the fact that he is a sword-bearer. His common names in all languages emphasize the sword idea. Thus the Italians call him *Pesce Spada*, and the French name him *Empereur*. *Imperator*, *Epée de Mer*, and *Espadon*.

The Greek and Roman poets, whose

knowledge of Xiphias was presumably obtained from the fishermen, and was at best superficial, were greatly impressed with his sword. They attributed to him a pugnacious nature. Earliest of all, Sophocles (496-406 B.C.) says of him:

What Fury, say artificer of ill,
Arm'd thee, O Xiphias, with thy pointed bill?

And Oppian (172-210 A.D.) speaks of Xiphias as "the sword-fish armed for war," says that the "hardy swordfish wields the threat'ning blade," and speaks of its "murd'rous use." Other ancients write in like vein of the fish and his weapon.

Modern writers, impressed by the apparently retaliatory attacks on the boats by the harpooned fish, have done their part to give him a "bad name." Thus in 1854 one writer said that Xiphias had a sword of a temper like that of its owner, and that neither was to be trusted. Another man alleged that the



Gloucester Chamber of Commerce

XIPHIAS IS DEPRIVED OF HIS WEAPON

THIS IS ALWAYS DONE PREPARATORY TO DRESSING THE FISH, BUT WHEN HE IS STILL ALIVE IT IS VERY NECESSARY SINCE HE MAY SLASH OUT WITH HIS SWORD AND WOUND A FISHERMAN.

fish was possessed of a "choleric disposition." And finally G. B. Goode in 1883 said that "It surely seems as if a temporary insanity sometimes takes possession of the fish."

That these pronouncements are more or less uncritical and based on insufficient evidence, I will now endeavor to show. The evidence to be presented of the psychology of *Xiphias* comes from men who have long fished for and studied the swordfish. And it is mainly from those who from their knowledge of *Xiphias* gain a livelihood by taking him for food—from market fishermen. This evidence will first of all establish it as a fact that *Xiphias* is temperamental—if such an anthropomorphic term may be applied to a fish.

The Swordfish is Temperamental.—

That this is true, has been incidentally noted above when discussing harpooning from the pulpits on the bowsprits of schooners. There it was stated that

Xiphias is apparently afraid of a small boat but not of a schooner under full sail—though afraid of the shadow of her sails. He will allow a schooner to approach until her bowsprit is over him but he never allows the forefoot to strike him. Sometimes he moves aside like a playful dolphin but anon like a bad-tempered dog who has to get out of the way but who resents the necessity.

In further support of the opinion that the swordfish is temperamental, the evidence will be presented of two men who have for long years hunted this fish. Their experiences certainly establish the fact that *Xiphias* is very temperamental, and temperament in a fish of the genus *Xiphias*, as in a member of the genus *Homo*, is something likely to lead to trouble.

The first of these men—Bandini—had for seventeen years angled for the swordfish in California waters when he wrote in 1933 that:

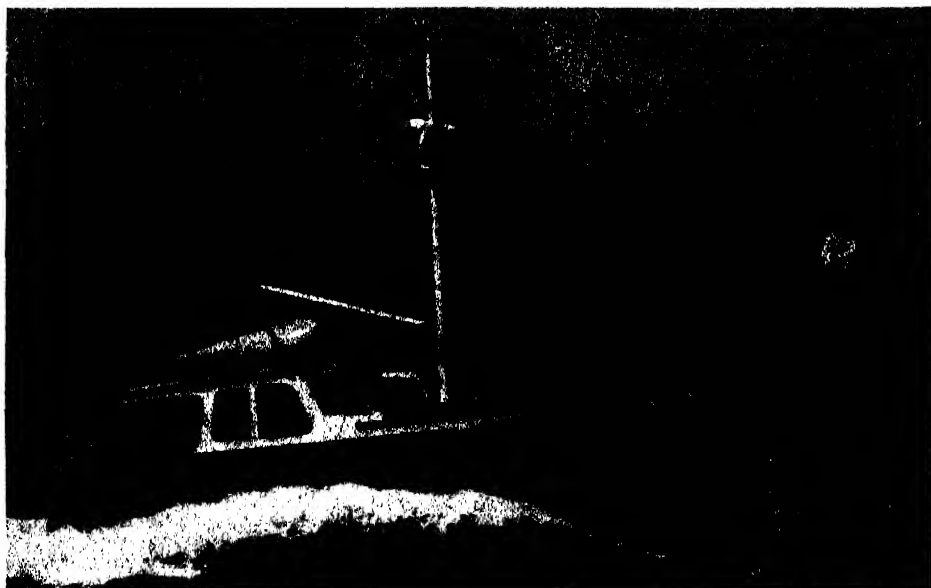

Matthews Company

A SPORTS CRUISER EQUIPPED FOR SWORDFISHING

THE PULPIT IS OF LIGHTER CONSTRUCTION THAN THOSE IN REGULAR "SWORDERS." SOMETIMES THE MAST, WITH SAIL AND SEAT FOR LOOKOUT, IS LACKING. THEN THERE MAY BE A LOOKOUT ON THE CABIN ROOF, OR THE PULPITEER MAY SERVE AS HIS OWN LOOKOUT.

No two swordfish act alike. You never know what the particular one you may be hooked on to will do. . . . [He] is an individualist if ever there was one, who never does the same thing twice running, who may sound hundreds of feet and sulk there all day and all night, or who may charge your boat time after time, sword out, great jaws wagging, the picture of insensate fury, or who may leap in great awkward lunges, throwing white water ten feet into the air as he smashes back, or who may deliberately swim right up to your boat and calmly look you over as though he were determining by observation just what tactics he will pursue. . . . Personally I do not think they are vicious if left alone, but if hooked they will fight back and who can blame them.

My valued correspondent, Mr. Hand, who after 25 years' seeking for and studying *Xiphias* in New England waters writes of our temperamental and individualistic fish that, even when struck with the harpoon, in head or in front of the dorsal fin, one can not be sure what the fish will do. He may attack, he may try to escape by swimming away or by diving deeply. Of the free and unhurt fish he says:

On some days the swordfish are very timid, very easily frightened and very difficult to approach; on others they seem to be wholly indifferent and act as if they believed themselves "monarchs of all they survey." Like many other fishes, they seem to be more wary and more difficult to capture on easterly days, but there are exceptions to this rule also.

Corroboratory of what Messrs. Bandini and Hand have written as to the unpredictable behavior of the unwounded swordfish, certain data as to the like unpredictable behavior of the wounded fish will now be presented. Thus it is related that a fleeing harpooned fish when brought so close to the boat that he could see the splash of water round her forefoot, turned and sunk his sword in her bow. Another fish harpooned back of the dorsal fin, when hauled in toward the boat, whirled about and charged the bow full tilt driving his sword in it nearly up to his eyes. But that the wounded fish does not always attack the bow of the boat to

which he is tethered but sometimes actually avoids the boat, is attested by the following account from Captain Oscar Johnson of the schooner "Edith Cooney." For it I am indebted to Mr. Firth.

A short time after it had been struck, one of the crew went out in a dory to haul the fish in and kill it in the usual manner. Every time that he hauled the line in, the fish would drive straight at the dory, and each time the man would slack off the line and the fish would retire. This being kept up for nearly four hours, the man became scared and finally came aboard the schooner without the fish. Capt. Johnson then brought the boat around to take in the fish, which had now become "public enemy No. 1," so far as the crew was concerned. As the line was hauled in, sure enough the fish dove straight at the schooner. But when only a few feet from the vessel it turned to one side and began to swim madly away from it, much to the amazement of every one.

Xiphias—a Timid, Not a Pugnacious Fish.—As shown above, the classical writers gave *Xiphias* a warlike name and a bad reputation and there have been many since who have declared that he surely has lived up to his reputation. But all along there have not been lacking those who have thought that the old adage of "a dog, a bad name, and hanging" applied to our fish, "armed as for war." Nor can it be denied that the combination of the long broad sword, and the huge staring eye (proportionally the largest in any known animal) do give *Xiphias* a sinister appearance. However, there are those who decry the idea of warlikeness and ferocity. On this point the testimony of experienced swordfishermen will now be given.

Since *Xiphias* has been hunted in the Strait of Messina from before the dawn of written history, testimony from that quarter will be welcome. This from L. Mazzulo, the chief Italian historian of this fishing, is very definite and positive. "It little, if at all, merits the name of a fiery and belligerent monster given it by the ancients; and it does not even attack the shark except to defend itself."

Since *Xiphias* has been sought as a food fish in our New England waters for over three-quarters of a century, with far more recorded retaliatory (?) attacks than the few off Messina, American testimony is very much in order.

It has long been said that swordfish sometimes go in pairs, presumably male and female, at the breeding season. But they never form schools, even when they temporarily collect in certain localities—presumably following the schooling fish on which they prey. But even before Goode's day (1883), it was known to American observers of the swordfish that these fish are solitary in habits, shy and easily frightened. Thus Goode (1883) quotes Captain Ashby that although 25 or 30 may sometimes be seen, two are rarely found together, and that they are generally at least 30 or 40 feet distant from each other. And many others since Goode's day have written that the fish do not go in schools, are timid, are easily scared, and that on some days it is very hard to get within striking distance of them.

This idea of the habits of the so-called warrior of the deep is commonly held by many experienced swordfishermen of the present day. This, Mr. Firth writes, is the testimony of Captain Ed. Smith and Mate Jud Stinson of the "Sunapee" who have been swordfishing together for 28 years. This is concurred in by mast-headman Bill Conrad and chief striker Archie Stevens who have only been in the game a mere 15 years. Keen observers all, they agree that:

The swordfish are perhaps the greatest cowards in the sea. In other words they are so easily scared that they jump away from each other when they happen to come in close proximity. Even a bit of floating seaweed may scare them away. They are not savage, but quite the opposite—they lean over backward the other way.

This then is the opinion of the innate character of *Xiphias* held to-day by practical commercial swordfishermen. These

men, close observers, in constant danger both in vessels and dories of the "retaliatory" (?) attacks of our fish, do not think him vindictive in spite of his "bad name." But, says the reader—"You have set out above many cases in which the harpooned swordfish has sunk his weapon in schooners and has stove dories. How are you going to explain these? Are not these accounts conclusive evidence against the idea of timidity and for that of vindictiveness?" These questions I will now try to answer, both for schooners and for dories.

WHY DOES THE SWORDFISH RAM SCHOONERS?

A. H. Clark states, on the authority of many swordfishermen of his day (1886), that if a swordfish is struck behind the dorsal fin, he generally runs to windward, and rarely charges the vessel even though the line be retained on board. This same opinion is held by many New England fishermen of the present day. But if the fish is struck in the head or spinal column, he seems to go berserk, swims crazily in circles seeking for something to attack—as various of the swordfishing captains have stated in emphatic unanimity. Such a harpooned fish, as instanced above in many cases, is thus tethered by the harpoon line attached to the keg as yet not thrown overboard. His sphere of action is limited, the bow of the schooner being the center and the harpoon line the radius. The fish dashes wildly about in great pain and fright. The pain is located in the place where the harpoon head is implanted. The taut line leading back to the schooner pulls on the harpoon and localizes the source of the hurt. To ease the pain, the fish follows the line towards the source of the pain, and strikes the boat head on, generally in the bow.

Mr. Hand has been quoted above that one fish, when harpooned from the pulpit, was headed for the vessel. The fish

came on at express speed following his original course and drove his sword into the vessel's bow. This automatic action is in my judgment the explanation for a certain number of cases of vessels struck in the bows. But for the great majority of cases, the explanation given in the preceding paragraph must hold.

WHY ARE DORIES "PUNCHED" BY XIPHIAS?

Ordinarily, when a swordfish has been harpooned, the line and keg are shortly thrown overboard and the fish is left to tire himself out hauling around the line with 600 feet of slack and at its end the keg, while the schooner goes in search of other prey. When it is thought that the swordfish has thus become sufficiently exhausted, a dory with one or two men is sent out to retrieve the keg by hauling on the line to bring boat and fish together

so that he may be killed by lance thrusts in the gill region. He is then hauled aboard the dory or if too large is lashed behind until the schooner picks both up.

If the fish is harpooned back of the dorsal and is given sufficient time, he generally exhausts himself by swimming away and by deep diving. In deep diving with the head down, the fish does not see the line and hence there is no tendency to follow this back to the boat. Some fishermen put a weight on the line near the harpoon head to induce the fish to go down deep. Such a fish is almost always pulled up dead, "drowned" the fishermen call it. If a fish is not pulled in too soon (before it is tired out), he is not likely to strike the boat. But if the fish is harpooned forward of the dorsal fin and hence in the head or spinal column he "goes crazy," dashes wildly about and is liable to attack anything in



A SWORDFISH RAMS A DORY

Captain Ira Abbott

THIS IS THE ONLY PHOTOGRAPH KNOWN TO HAVE BEEN TAKEN AT THE MOMENT OF PENETRATION.

sight, whether schooner or dory. And any fish, wounded anywhere, is likely to attack if not sufficiently "worn down."

In an earlier paper (1938) I have given in some detail the testimony of various swordfishermen—captains, strikers and dorymen—that a fish struck in the head is always dangerous and that to pull such a one in too soon is almost surely to invite an attack. Perhaps I can not do better than to repeat here what I have said in that paper. "Even then (as Captain Ed. Smith puts it) the fish does not attack the boat but rather the warp line which is being hauled into the boat with the fish on it, and consequently the fish slams its sword into the boat." Most fishermen do not believe that the fish intentionally attacks the boat.

However, another view is held by Mr. Hand, who in 25 years' fishing has taken over 500 swordfish, and his testimony can not be passed over lightly. He states that he has never seen a fish deliberately attack a schooner or other large vessel, but that he has seen a number of swordfish apparently deliberately attack dories. In another letter he writes that:—

Swordfish do deliberately attack dories at times. This I have seen with my own eyes on a number of occasions. I have seen fish try several times before contacting the dory properly to drive the sword through. There is not the slightest doubt in my mind that on occasions swordfish will attack dories. It is usually the smaller fish that do this. [On this latter point Captain H. L. Smith is in agreement] In my opinion it makes very little difference where they are struck.

The reader now has the proof that swordfish ram dories. The testimony is incontrovertible. But he still has the question—"In the face of these different opinions by dependable men of much experience in swordfishing, what conclusion can I draw as to the real cause of these attacks?" I have unfortunately never been swordfishing and I have never seen a dory rammed. But I have thought much over this conflicting testimony and have tried to form a conclusion of my own.

That a swordfish struck in or near the head (in the forward spinal column or brain) would have his nervous system disorganized and would lose its sense of equilibrium is readily understandable. That such a fish held by a line would gyrate around in circles with that line as a radius seems sure. That such a stricken fish when hauled in toward the dory, in order to ease the pain increased by the pull of the line on the harpoon imbedded in the flesh, would follow the warp straight toward the boat is readily understandable. That this fish, when close enough to perceive the boat ahead of it, would associate it with the cause of its pain and loss of freedom seems very probable. That it might conceive that the boat was an enemy which was responsible for its pain and detention, seems the most plausible thing in the world.

If these are sound conclusions, then we may go further and expect the attack to follow, and it would then look like a deliberate one.

SOLAR RADIATION AND THE STATE OF THE ATMOSPHERE

By Dr. HARLAN TRUE STETSON

MASSACHUSETTS INSTITUTE OF TECHNOLOGY

FOR a week before the great aurora of September 18, 1941, with the attendant wide-spread disturbances to radio communication, the sun had been heralding the event. Although the sunspot cycle has been definitely on the wane since 1937, the week preceding the 18th presented one of the largest groups of spots seen in recent years, so conspicuous, in fact, that it was visible to the naked eye through suitable dark glasses. The forecasting of interruptions to radio communication is of increasing significance in these days of national defense, but the ability to foresee communication interruptions has been a recent result of intensified interest in the study of relationships between solar disturbances and terrestrial atmospheric conditions.

The sun is a typical star of rather ordinary proportions, but because of our proximity to it, the sun is the one star upon whose radiations activities on the earth are unalterably dependent. Military campaigns as well as agriculture since the dawn of civilization must be governed by the seasons for which the changing declination of the sun is the major astronomical factor. With the conquest of the upper air for transportation and the use of atmospheric electric waves for world-wide radio communication, the study of the sun's radiations in relation to our atmosphere has become an astronomical problem of far more than academic interest.

Not a day passes but that our United States Naval Observatory in cooperation with other observatories has a complete photographic record of the conditions of the sun's surface. When a huge solar storm is in the making, communication

agencies are forewarned days in advance of probable periods of interrupted radio reception. The question of the relation of sunspots to the forecasting of weather is still in a controversial stage, but meteorologists are beginning to realize the increasing significance of conditions in the high atmosphere to the lower regions in which our weather appears to arise. All weather is fundamentally traceable to solar radiation. The amount and the character of this radiation, particularly in its relationship to atmospheric phenomena, merits more detailed consideration.

From observations at the Smithsonian Institution, the amount of energy that the sun emits has been measured with such precision that we know not only the quantity of heat and light emitted, but that this quantity varies from time to time by some 2 or 3 per cent. The average energy received by the earth from the sun is about 450 million million

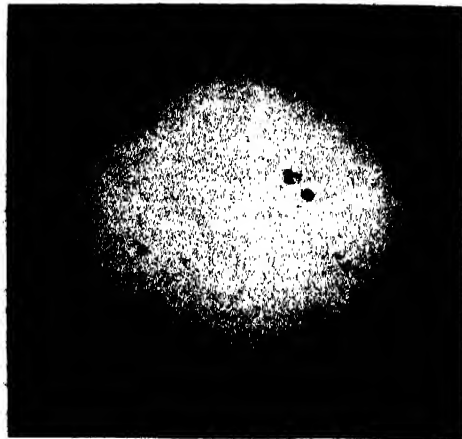

William M. Kearons
FIG. 1. THE SUN, JULY 9, 1937, DURING PERIOD OF MAXIMUM SUNSPOT ACTIVITY.

horsepower. Because of the relatively insignificant size of the earth, and also the great distance that separates us from the sun a distance of 93 million miles, our planet can intercept but about one two billionths of the total solar output. Even so, if we stop to consider what the cost to us would be were we charged for a year's service of heat and light from the Solar Utilities Power and Light Company, we would find our indebtedness mounting to staggering proportions. At a price of 1½ cents per kilowatt hour, the annual budget that would have to be allowed for sunshine for the continental United States alone would represent an expenditure of 327 quadrillion dollars. Such figures are indeed difficult to imagine. If we change our picture to a more restricted one, we can say that the cost of sunshine for Greater New York at the above figure would amount to approximately 100 million dollars for the average day. Fortunately for us, millions of years ago this same sunshine provided the energy for growing the vast tropical forests of the carboniferous era. The carbon in those fallen tree trunks that we are mining to-day in the form of coal together with the water power provided by the vast irrigating systems maintained by the sun's radiation is the source for the maintenance of our public utilities and industries to-day. It is an interesting question as to how long the sun could have maintained its present output of radiation and how far into the future we may rely upon its ability to furnish us with this all-essential source of energy. It appears probable that within the hot interior of the sun, which may be estimated in terms of millions of degrees, an atomic transmutation is taking place that has been going on for millions of years and is likely to continue for a long time to come. Through an ingenious carbon cycle recently worked out by Professor Bethe, of Cornell University, we picture the ultimate trans-

formation of hydrogen into helium with the continual release of energy in the form of radiation that represents a loss of mass to the sun of some 4,200,000 tons every second. We scarcely need worry, however, about the deterioration of the fuel supply while the sun has about 2,000,000,000,000,000,000,000,000 tons of matter still left in it.

If we analyze the radiation from the sun we discover that it covers a wide range of wave-lengths. Certain of these wave-lengths or frequencies produce their own special effects upon the earth and its atmosphere.

We are all familiar with the fact that if sunlight is split into its component colors by means of a spectroscope we can see a large variety of the radiations represented by the various parts or colors of the solar spectrum. The visible range to which the eye responds represents frequencies extending from 400 million million cycles per second to a frequency just about double this, or 800 million million cycles per second. The sensation of the higher of these two frequencies is that of violet light, and the sensation produced by the 400 million million cycle frequency is that of deep red light. In between these two extremes of the spectrum fall the intervening colors. But outside this so-called visible range to which the eye responds there is a vast scale of radiations both beyond the red end of the spectrum, which we call the infrared, and far down below the violet, which we call the ultra-violet.

By means of the photographic plate, we can extend the map of the spectrum in either direction. Far out beyond the red end are heat radiations from the sun that may be measured with the thermopile or the bolometer. To-day much research is being done in measuring the extremely short waves, or high-frequency radiations out beyond the violet, for the ultra-violet is coming to have increasing importance not only from the

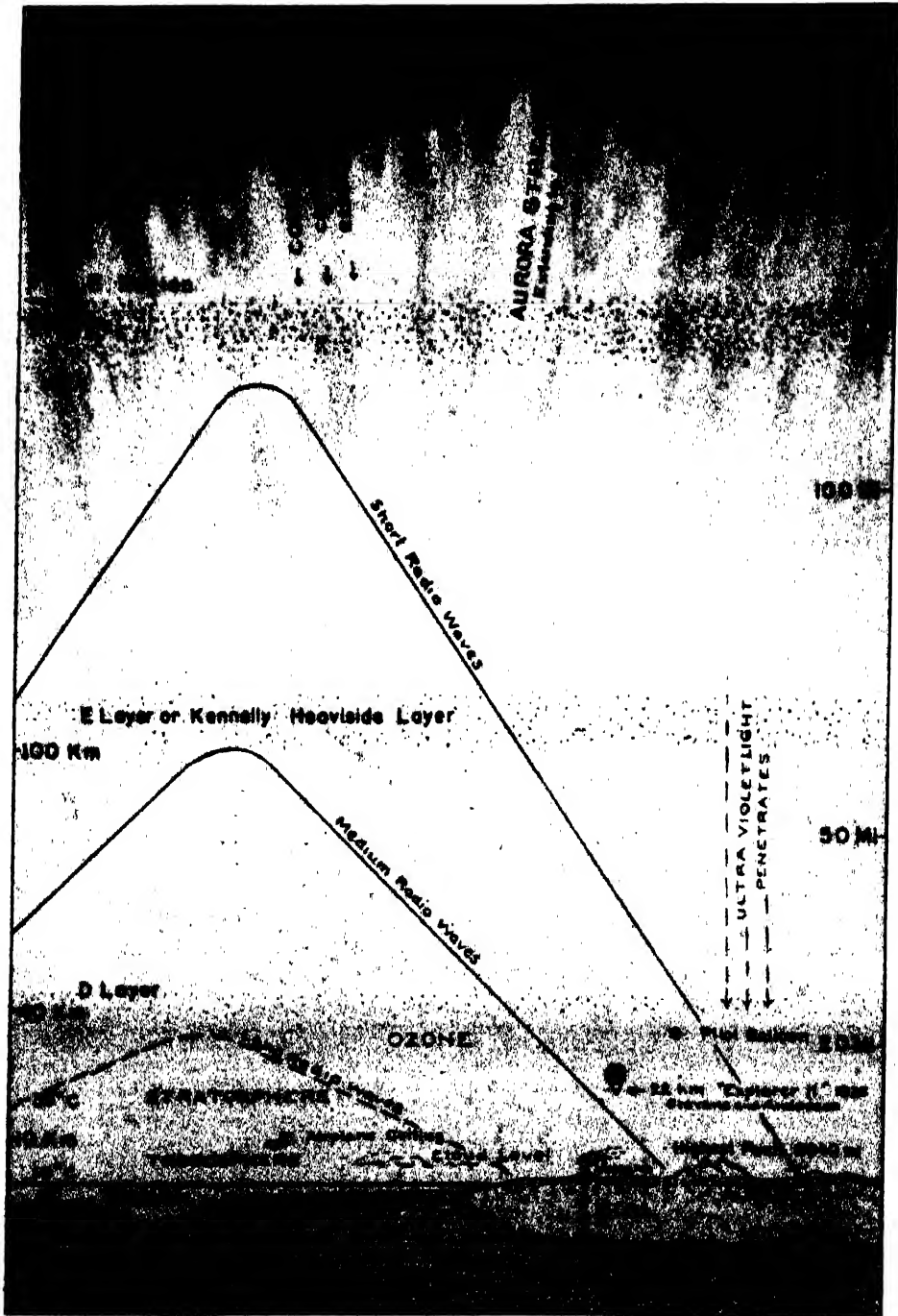

FIG. 2. CROSS SECTION OF EARTH'S ATMOSPHERE.

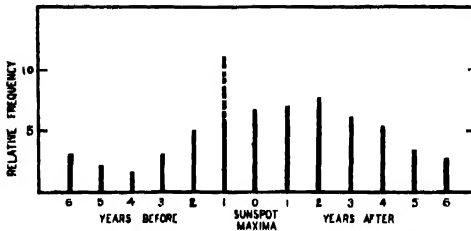

FIG. 3. RELATIVE FREQUENCY OF OCCURRENCES OF AURORAE AT THE BLUE HILL OBSERVATORY BEFORE AND AFTER YEARS OF SUNSPOT MAXIMA.

point of view of health but from the point of view of the radio engineer.

The sunlight which we measure or analyze at the earth's surface is, however, seriously modified by the absorption introduced by the constituents of our own atmosphere. As we all know, the earth's atmosphere consists of nearly $\frac{1}{2}$ oxygen and $\frac{2}{3}$ nitrogen. There is a sprinkling of carbon dioxide with a bit of argon, neon, krypton, xenon and a trace of helium. Here at the earth's surface we can count on a little more than 1 per cent. of water vapor. For a thorough mixing of the elements of this atmosphere and the maintenance of its temperature as well as the variation in its temperature, we rely upon the sun. Occasionally we have vividly impressed upon us the relationship of our atmosphere to disturbances on the sun, by displays of aurorae or the Polar Lights, often flaming gorgeously red and stretching 100 miles above the earth. These glowing electric discharges advertise the lofty air swarming with the traffic of electrons, ions and particles, jostling one another as they are excited by radiations from the sun peculiar to the occurrences of sunspot activity.

Observations with the spectroscope indicate that there is much radiation at the extreme ultra-violet end of the spectrum to which the earth's atmosphere is completely opaque. A great deal of the absorption of this region of the solar spectrum of very short wave-lengths is

caused by a layer of ozone which exists at an average height of about 22 kilometers, but which probably occupies a region extending from 15 to 35 kilometers. If all the ozone in this region were to be brought to the standard conditions of temperature and pressure of our atmosphere at the earth's surface, it would represent a layer of only 2 to 3 millimeters in thickness. Yet this small amount of ozone is the defense between us and extremely dangerous radiations in the ultra-violet region of the sun's light. Were the absorption, however, of this region of the solar spectrum even a little greater than it is, we should be deprived of that small amount of ultra-violet light filtering through our atmosphere that is so essential for health and the production of our sunshine vitamin D. Whether or not variations in the sun's radiation are sufficiently great or changes in the absorption of the earth's atmosphere sufficiently large to bring about dangerous variations in the production of vitamin D in living organisms at the earth's surface is an interesting question for speculation and for investigation.

We can be confident, however, that it is a fortunate combination of the sun and our atmosphere that makes life on the earth possible. The sun not only radiates its health-giving sunshine, but it also emits literally death-dealing rays. Were it not for the protecting shield of the earth's atmosphere, the sun would be the annihilator of us all. The atmosphere provides on the one hand oxygen for maintaining life, and on the other hand protects us from the highly penetrating rays. It is a sort of a buffer state, the very top of which receives a violent bombardment of high frequency radiations from the sun, and the lower layers of which form a blanket that enables the earth to retain during the night much of the warmth generated by the sunshine that has penetrated through

it, thus mitigating the extremes of temperature between night and day to which the earth would otherwise be subjected.

If we look at a cross-section of the earth's atmosphere, it may for convenience be divided into three zones or layers in which the stratosphere occupies the middle ground. The region below the stratosphere is that which contacts our immediate surroundings and provides the winds and atmospheric currents, giving rise to all our weather. We call this lower region comprising perhaps the first 5 or 6 miles the troposphere. The region above the stratosphere is the ionosphere. If we send a recording thermometer aloft, we find that while passing through the troposphere the temperature steadily falls until a height of 10 or 12 kilometers is reached, when the temperature reaches the extremely low value of -55° C., or some 68° below zero Fahrenheit. Strangely enough, for the next 30 miles or so there appears to be little change in temperature. This is the region of the stratosphere. The weather forecaster for the stratosphere would have a relatively simple task, for day after day, year in and year out, his prognostications would be "clear and cool," and his forecasts would be 100 per cent. correct. At a height of 60 kilometers or some 40 miles, the temperature would begin to rise again. Recent investigations give some evidence that at extreme heights, up where the auroral fires play, temperatures of $1,000^{\circ}$ C. have to be postulated to account for the presence of the ionized oxygen that is there. The extremely rarefied condition of this upper atmosphere, however, calls for perhaps a quite different interpretation of temperature than that to which we are ordinarily accustomed when determining temperatures by the thermometer at the earth's surface.

Ascending through the cross-sections of the atmosphere, we find there is a rapid decrease in the amount of atmos-

pheric pressure. Within the first 3 miles from the earth's surface, half the total amount of oxygen and nitrogen, the principal atmospheric ingredients, are included. The limiting height to which the thinning atmosphere extends is somewhat difficult to fix. Perhaps we should place it at 200 to 300 miles, although recently Dr. Carl Störmer has observed auroral streamers reaching to heights of 600 kilometers or more. Where auroral streamers go, some of the thin atmosphere must extend.

If we make a chart of the numbers and occurrences of aurorae we find there seems to be a curious connection between the frequency and brightness of auroral displays and the state of the sun as marked by the appearance of sunspots. Professor Brooks, director of the Blue Hill Observatory, has kindly allowed me access to the records made of aurorae at that station for the last 30 years. Utilizing the observations of the brighter aurorae, we may make a graph showing the variations in the auroral frequencies occurring in years distributed with respect to the maximum occurrences of sunspots. The fewest number of aurorae appear to occur from 4 to 6 years before or after the years marking sunspot maxima. The time when aurorae appear most frequently would seem to be about 2 years after the passing of the maximum of sunspots. These results corroborate rather well those of a longer series of observations tabulated by Dr. Chree extending for over 100 years, or from 1750 to 1877.

The fact that aurorae occur with far greater frequency during years when sunspots are more numerous than during the years when there is a scarcity of sunspots suggests that the electrical effect in the upper atmosphere is something for which a disturbed solar surface is responsible. There is, I believe, a good reason for the fact that the maximum in the auroral displays occurs a year or two after the year of most sunspots. As sun-

spots begin to wane in numbers, they are nevertheless occurring in regions progressively nearer the solar equator, and as the sun's equator is inclined but slightly to the plane of the earth's orbit, we may draw the inference that sunspots are most effectively associated with the occurrence of aurorae when, other things being equal, they are most nearly in the geometrical plane that the earth travels in its journey around the sun.

Much of our present knowledge of aurorae is due to the exhaustive studies and mathematical calculations of Dr. Störmer, of Blindern, Norway. By careful analysis of the motion of charged particles in the magnetic field of the earth, he has been able to deduce tracks of ionization so simulating auroral forms as to indicate very significantly that such discharges in the upper atmosphere are indeed the result of bombardments of electrons coming in from outside, warped by the magnetic field of the earth. In endeavoring to express such phenomena on an electronic hypothesis we may well look at the sun, therefore, for a consideration of the character of sunspots and so trace any possible mechanism by which corpuscular charges might be ejected in the region of the sunspots themselves.

When we look at an enlarged view of a sunspot and analyze the light from it, we find that the dark interior center is surrounded by a turbulent area. Photographs taken in the light emitted by hydrogen at a particular frequency reveal that there are whirling masses of gas, arranging themselves in veritable vortices. There is every indication, then, that a sunspot is in reality a terrific solar hurricane. It was in 1908 that the late Dr. George Ellery Hale, the founder and director of the Mount Wilson Observatory, first observed that sunspots were giant cyclones in the sun's atmosphere. They are indeed very similar in their formation to the tropical hurricanes that origi-

nate in the West Indies and sweep northward.

With photographic emulsions made especially sensitive to the red light emitted by hydrogen, there may be photographed on a moving film the entire solar surface so far as it is covered by bright luminous hydrogen clouds. The resulting representations of the sun appear very different from photographs made in ordinary light. Not only are large clouds of hydrogen gas discernible all over the sun, but in the neighborhood of sunspots they often seem to be swept into the heart of the spot as if they were caught in the center of a whirlpool. Such an appearance might be presented by the top of a terrestrial cyclone or tornado if photographed from a stratospheric balloon. The dark center of the spot forms the center of the vortex; the outlying shaded region that characterizes the so-called penumbra of the sunspot would represent the turbulence bordering upon the central funnel about which the atmospheric particles are rapidly rotating. Thus we see there is a close analogy between the meteorology of tropical cyclones and that of sunspots. To carry the analogy still further, spots north of the sun's equator are in general whirling in one direction while corresponding spots south of the equator whirl in the opposite direction. If the rotation of the one is clockwise, that of the other is counter-clockwise. This again is characteristic of the differences of rotation of tropical hurricanes on the earth originating in the northern and southern hemispheres, respectively.

Had it not been for the trick of splitting up sunlight into isolated frequencies by means of the spectroscope, we should never have had pictures showing the existence of solar vortices such as we have to-day. In the ordinary photograph of the sun, the light emitted by every chemical element in the sun's atmosphere is clamoring to tell its story.

The result is revealed in a rather jumbled picture of what is happening on the sun. The spots show up as dark regions only when the light-emitting power of every element of the sun is damaged in the vicinity of these violently disturbed regions.

The spectroscope is very much like a highly selective radio receiving set. The sun is a high-powered station sending out light, broadcast in all the wave-lengths and frequencies. When we look at the sun or photograph it with a telescope alone, we are using all the light and are, so to speak, operating a radio receiver which admits all frequencies at once. Thus we get a composite but very jumbled picture of what is happening on the sun's surface so far as details are concerned. By means of the spectroscope, however, the photographic apparatus, to continue our analogy, may be tuned to a single frequency such as the 470 million megacycle frequency that the red line of hydrogen emits. Tuned to this frequency the spectroscope stills the tumult of all other elements and lets hydrogen tell its own story. It is then that we obtain the clear photographs conveying so beautifully the detailed information about the vortical whirls around the solar storm centers that would otherwise be lost in the jumble of too many story-tellers.

It has long been known that the frequencies of light waves are distorted if there is a powerful magnetic field surrounding the light source. This had been demonstrated in the laboratory shortly after the reason for such a phenomenon had been given by Zeeman in 1894. When the Mount Wilson observers first examined and actually measured the frequency of light coming from the centers of sunspots, it was found to have changed frequency in exactly the way that light waves are distorted in the laboratory when a powerful electromagnet is placed around the source of light being

examined. If additional proof were needed for the explanation of the changed frequencies, it may be stated that the double and triple lines found in the spectrum of sunspots indicated that the light was polarized just as in the case of the polarized light waves coming from the laboratory source upon which the magnetic field is impressed. Thus came the startling revelation that sunspots



FIG. 4. APPARATUS USED IN RECORDING CONTINUOUS NIGHTLY FIELDS FROM WBBM CHICAGO AT NEEDHAM LABORATORY.

were not only terrific hurricanes but every center was in itself a powerful magnet. Since a magnetic field may exert a repulsing effect upon swiftly moving electrons, we see some reason that charged electric particles can be actually hurled from sunspot centers at velocities which may carry them through space into the earth's atmosphere, thus ionizing the upper regions of the air in a way that would produce auroral displays. In

the light of such a mechanism, therefore, we see a possible reason why aurorae occur in greater numbers and at greater brilliance at times when these solar storms occur most frequently.

With the new unsurpassed equipment installed at the McMath-Hulbert Observatory of the University of Michigan, motion pictures of the sun's surface have been made on many different frequencies of the sun's radiation. These cinematographic records promise more material for the intense study of the behavior of the solar surface than has ever before been available. Some of the movements in the high solar atmosphere over the regions of sunspots revealed by this new process of recording continuous motion at present defy explanation and may yet completely revolutionize our ideas of the sun's behavior pattern.

Perhaps the terrestrial effect that has most nearly paralleled the sunspot cycle is the variation in the state of the earth's magnetic field. For over 100 years, it has been definitely known that the direction of the compass needle and the intensity of the earth's magnetic field show definite relationships. In the years when sunspots are most numerous magnetic disturbances are most frequent and

appear with marked intensity. The years when sunspots are most numerous follow with more or less regularity an interval of somewhat over a decade between the times of maximum sunspot activity. This solar cycle, or sunspot period as we sometimes call it, is usually conceded to be on the average of about 11.3 years duration. An examination of a graph will show that sometimes the interval between maxima may be as short as 9 years and on occasion as long as 17 years.

The last maximum of sunspots was passed in 1937 and we are well on our way on the down side of the cycle. It was not until the more recent discovery of an ionized region in the upper atmosphere of the earth that any real explanation appeared as to why sunspots and changes in the earth's magnetic field should show so close a parallelism.

Every one knows in a general way that the earth is a magnetic sphere. That the compass needle does not point true north except in various restricted parts of the globe is also a fact which is generally recognized. Perhaps comparatively few who are not geomagneticians realize that the compass needle is constantly wandering back and forth every day by a slight

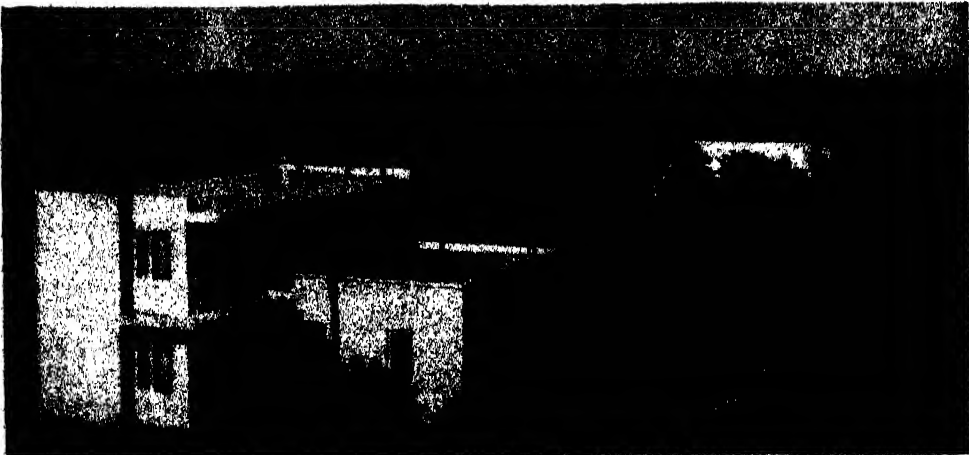

FIG. 5. NEWLY ESTABLISHED LABORATORY FOR COSMIC TERRESTRIAL RESEARCH IN NEEDHAM, MASSACHUSETTS. THE RESIDENCE OF THE DIRECTOR IS IN THE BACKGROUND AT THE RIGHT.

amount. When the sun rises in the east, the north end of the compass needle turns slightly toward that direction. By noon when the sun is south, it is pointed in its normal position. Then in the afternoon as the sun wanders and sets in the west, the compass needle wanders likewise to the west, coming back again to its normal position about midnight when the sun is below the northern horizon. This goes on day after day, month after month—but during the years when sunspots are most numerous these daily excursions of the compass needle will on the average be twice as great as during the years when sunspots are lacking. These diurnal wanderings of the compass needle can now be roughly explained as due to the effects of ionization of the upper atmosphere by sunlight. As the electric charges become separated in the process of ionization of the molecules of nitrogen and oxygen under the bombardment of ultra-violet light from the sun, the movements of these ions create a perceptible current, deflecting the compass needle from its normal magnetic position. We may infer, therefore, that at times of sunspot maxima the number of these ions in the upper air is materially increased, producing a more marked magnetic effect. The strength of the magnetic field of the earth, therefore, may be considered as increasing and decreasing with the variation in the intensity of the ionization of the upper air that changes with sunspot occurrences. Most of our knowledge of the ionized region has come about through the invention of radio.

In the early days of wireless, it was thought that electric waves which carried telegraph messages without wires traveled in straight lines over the earth, just as light waves do. With this conception one could never hope to communicate over very great distances, since the curvature of the earth would prevent the passage of the waves as the earth's

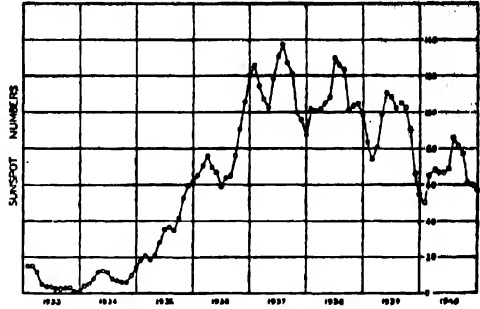

FIG. 6. THE TREND OF SUNSPOT ACTIVITY HAS BEEN DEFINITELY DOWNWARDS SINCE 1937. CURVE OF SUNSPOT NUMBERS SMOOTHED BY THREE MONTHS MOVING AVERAGES.

huge bulk bulged into the communication path. The earlier wireless engineers thought that only by building higher and higher antenna towers could one ultimately hope to communicate over the thousands of miles that would make trans-oceanic wireless possible.

Of course, these early crude notions about the way in which electric waves travel were erroneous. Such, nevertheless, is the way in which science has groped into the unknown. Somebody experimenting with wireless and listening in found himself quite unconsciously eavesdropping on Marconi waves from the other side of the Atlantic. Instantly the thought about how wireless waves travel had to be changed. Evidently the electromagnetic waves followed the curvature of the earth and did not travel in straight lines after all. This led Professor Kennelly of Harvard to postulate that there must exist high above the earth's surface, perhaps 100 miles or so up, an electrified conducting layer from which the electromagnetic waves emitted from the powerful antennae were reflected back to earth. The earth's upper atmosphere, therefore, in his mind formed a conducting layer and imprisoned the radio waves between the earth's surface and space outside. A few months after Professor Kennelly published his hypothesis, the English

scientist, Oliver Heaviside, announced a similar conclusion quite independently. In honor of these two distinguished men this upper region of the earth's atmosphere that is electrically ionized is commonly referred to as the Kennelly-Heaviside layer, also designated as the E layer.

If we look at a diagram which presents a vertical section of the earth and its

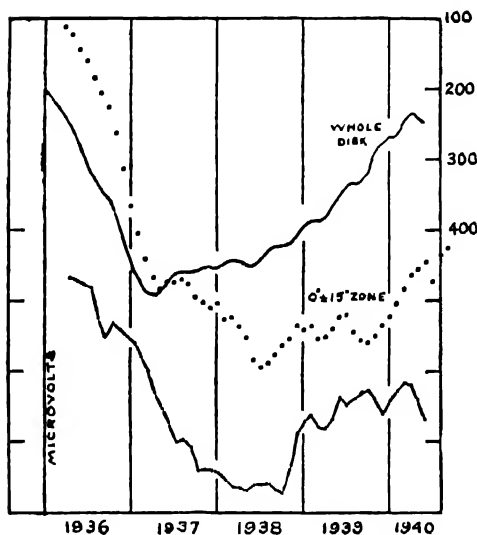

FIG. 7. TREND OF RADIO FIELD STRENGTHS OF WBBM RECEIVED IN BOSTON COMPARED WITH SUNSPOT ACTIVITY, 1936-1940. FULL LINE CURVE REPRESENTS SUNSPOT NUMBERS OVER ENTIRE DISK OF THE SUN; DOTTED CURVE REPRESENTS VARIATION IN AREAS OF SUNSPOTS IN ZONES OF SOLAR LATITUDE 0° TO $\pm 15^{\circ}$ EITHER SIDE OF THE SUN'S EQUATOR. LOWEST CURVE REPRESENTS VARIATION IN RADIO FIELD STRENGTHS CORRECTED FOR SEASONAL AND DIURNAL VARIATIONS DUE TO ANGLE OF THE SUN BELOW THE HORIZON. THE FACT THAT THE LOWEST CURVE PARALLELS CLOSELY SUNSPOT ACTIVITY IN THE 0° TO $\pm 15^{\circ}$ ZONES SUGGESTS EFFECT OF SOLAR DISTURBANCES IS GREATEST WHEN SPOTS ARE NEAR SOLAR EQUATOR.

atmosphere, we see that this Kennelly-Heaviside layer exists at an altitude of from 100 to 130 kilometers. Radio waves emitted from a sending station in all directions arriving in this ionized region have their velocity and direction changed as they penetrate further and further into the region, until at length they are

bent back to earth again, reaching receiving stations hundreds and sometimes thousands of miles from the source whence they were broadcast. This region lies far above the stratosphere and generally above the region that is usually regarded as that where ozone is manufactured. This E layer is particularly favorable for reflecting or turning back radio waves of the frequencies which are most generally used for commercial broadcasting in connection with our entertainment programs. Radio waves of much shorter wave-lengths or of higher frequencies penetrate and actually traverse through this region until they reach what appears to be another ionized region called the F layer, originally postulated by Professor Appleton in England. This F layer lies some 200 kilometers high or in the territory where auroral streamers stage their gorgeous displays. If the ionization of these upper regions is more intense as we near the period of maximum sunspot activity, one might well expect that some change might be observed in connection with radio transmission.

Anticipating a new field of research, a Boston radio engineer, Mr. G. W. Pickard, and myself became interested in the making of quantitative measurements of radio reception during the sunspot maximum of 1928 in an endeavor to discover if such anticipated effects on radio communication could be measured. After a few years' observations, it appeared to be evident that when solar activity decreased, the field strength of a Chicago broadcasting station observed in Boston notably weakened, whereas as sunspots became less numerous there was a marked increase in the intensity of the radio waves from Chicago. A similar investigation carried on during the decline of sunspots from 1930 to 1932 between Chicago and the Perkins Observatory of Delaware, Ohio, yielded data to indicate that with a decrease of sunspots from a monthly average of 60 at the be-

ginning of 1930 to a monthly average of about 10 in 1932, radio reception increased six-fold in its intensity.

Continued observations of the Chicago-Boston field strengths in recent years have continued to substantiate the general effect earlier observed. While there may be a 600 per cent. change in the field strengths between a sunspot maximum and a sunspot minimum, this does not mean that the degree of ionization in the Kennelly-Heaviside layer has been altered by this amount. The field strength of a radio wave at a given distance for a given frequency depends upon the angle of reflection or refraction which in turn is dependent upon the degree of ionization. Field strength also depends upon the absorption of the waves, which is a function of the conductivity. Appleton has estimated from his observations that the ionization and the electrical conductivity of the E and F regions in passing from sunspot maximum to sunspot minimum have shown variations of 50 to 60 per cent. implying that the solar ionizing agent (ultraviolet light) responsible for the formation of these regions in the ionosphere varies from 120 to 150 per cent. during the sunspot cycle.

We thus see that radio becomes a sensitive and extremely useful tool in recording changes of degree of ionization of the upper atmosphere. When we observe radio field strengths at long distances we are in a way tracing an integrated effect throughout the whole transmission path for a given frequency.

Another way in which we gain important information as to the sun's effect upon the upper atmosphere is by making radio soundings from day to day. This method, which has been in use for some years at the National Bureau of Standards, at the Department of Terrestrial Magnetism of the Carnegie Institution in Washington and elsewhere, consists in sending up a radio pulse of known fre-

quency and recording its return from the reflecting layer. The time elapsed while the wave was traveling this path to the ionosphere and back is measured with high precision on an oscillograph. Assuming that the radio wave travels with the velocity of light, one can calculate from the elapsed time the height to which the pulse ascended before it was turned back by the ionosphere.

Soundings made of the ionosphere reveal different conditions at various times, displaying marked changes in the ionic density that are dependent upon the hour of the day and the season of the year. Routine radio soundings include changing the frequency at which the radio pulse is emitted. If the frequency is sufficiently increased, the shorter and more penetrating waves may pass completely through the ionized layer and not return. When such a frequency is attained, it is known as the critical frequency.

The close relation between the observed critical frequencies and the rise and fall in solar activity marked by sunspot numbers has been so apparent during the last ten years that the National Bureau of Standards now undertakes to predict three months in advance the best usable frequencies for radio communication based upon the sunspot cycle.

During the last few years of sunspot activity, there have been occasions when remarkable fadeouts have occurred in radio communication. In several of these instances extraordinary explosions have occurred on the sun simultaneously with the interruption of all radio communication in general. It would appear that the intense ionizing radiation from the region of the sun where these eruptions occur reaches the earth with the velocity of light and of sufficient intensity to disturb immediately the ionized layer, confusing the reflection of radio waves, and thereby resulting in these fadeouts which sometimes last for an

hour or more. Records at magnetic observatories show that during such instances characteristics of the earth's magnetic field are likewise suddenly altered.

Could we visualize the ethereal substance of the ionosphere as we visualize the surface of the ocean, we should find times when terrific storms were raging in this ionosphere. Here ions and electrons are being hurled hither and yon as

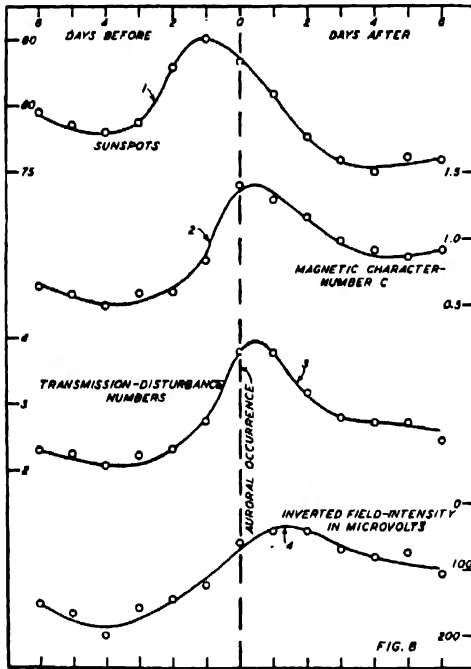

FIG. 8. CURVE SHOWING CORRESPONDENCE BETWEEN SUNSPOT ACTIVITY, TERRESTRIAL MAGNETIC CHANGES, DISTURBANCES IN THE F LAYER AND FIELD STRENGTHS IN THE BROADCAST BAND (E LAYER). ALL ARE PLOTTED WITH RESPECT TO DAYS BEFORE AND AFTER BRIGHT AURORAE.

though some great electrical wind played upon its surface, creating waves literally miles high. Frequently the turbulence attains such proportions that no reflecting surface for radio communication seems possible at all. When disturbances on the sun subside, the undulations in the ionosphere may quiet down and

there is a return to more normal conditions for communication traffic through this ocean of the upper air.

While knowledge of the sun has helped us to understand the vagaries of radio, we are coming to see that radio is one of the most important tools for learning about what happens on the sun and how disturbances there affect the ions in this upper air. Perhaps some day, even though the sky is cloudy, we shall have a sufficient number of reports of radio conditions over the globe so that we can form a very good idea as to what is happening on the surface of the sun by the way in which world-wide radio communication behaves. Unlike the telescope, radio apparatus does not go out of commission when the sky is overcast, for electric waves, of course, pass through the clouds as easily as ordinary daylight comes through window glass.

Concerning the exact method or methods by means of which the sun produces all these electric disturbances of the upper air with the concomitant magnetic variations in the earth, we still lack a great deal of knowledge. The fact that the ultra-violet radiation from the sun is the major factor in producing this ionization appears a reasonable assumption. Whether or not in addition to the effect of the ultra-violet light, streams of charged particles also emanate from the sun in the regions of sunspots is perhaps still debatable, yet there is accumulating evidence that in addition to the wave radiation from the sun there is also a particle radiation that is primarily responsible for the violent magnetic disturbances such as accompanied the marked solar activity of Easter Week in 1940. The elaborate mathematical work of Dr. Störmer, in calculating the movements of hypothetical charged particles from the sun striking the upper atmosphere of the earth and thereby producing aurorae, would certainly seem to favor the idea that corpuscular radiation

of some sort is responsible for this phenomenon.

We have recently made a study of our last ten years of recordings of field strengths from WBBM Chicago as received in the vicinity of Boston for days immediately preceding and following conspicuous auroral displays. Comparisons have also been made of the index of sunspottedness for the same intervals. It was immediately apparent from our statistical analysis that on the average auroral displays followed by one day the highest value of sunspottedness, and that on the average one to two days after the auroral displays occurred, the weakest field strengths on the 770 kc. frequency were recorded. Since waves in the broadcast band are returned from the E layer of the ionosphere, it would appear that there is a definite lag of from 24 to 48 hours between the disturbances in the auroral zone and the greatest deterioration (ionization) in the E layer. Had we similar measurements of field strengths at higher frequencies representing waves returning from the F layer, we might expect a similar effect to occur at an interval intermittent between the time of maximum auroral display and the time of minimum field strengths from the E layer. Such field strength measurements are not available, but fortunately through the courtesy of the Bell Telephone Laboratories we had available a record of their transmission disturbances over oceanic paths. Taking the reciprocal of these transmission disturbance numbers, we have an index of transmission conditions comparable to the field strength measurements in the broadcast band. A plot of these transmission disturbances for reception from the F layer indicated a lag of roughly twelve hours after the auroral displays for the minimum transmission conditions. This provides perhaps as clear a confirmation as could have been anticipated for ionization disturbances occur-

Seasonal Variation in WBBM

1936-1940

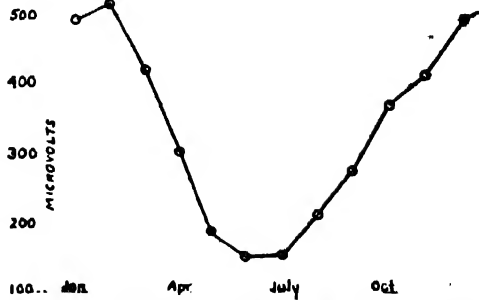

FIG. 9. SEASONAL TREND OF RADIO FIELD STRENGTHS (NIGHT) OF WBBM (770 KC.) AS RECEIVED AT BOSTON. VALUES HERE REPRESENTED ARE ST CORRECTED FOR TWILIGHT EFFECT; WHICH DEPENDS UPON ANGLE OF DEPRESSION OF THE SUN BELOW THE HORIZON DURING PERIODS OF OBSERVATION.

ring more promptly in the F layer than in the E layer. The curve of magnetic disturbances in the earth's field parallels very closely that of transmission disturbances in the F layer.

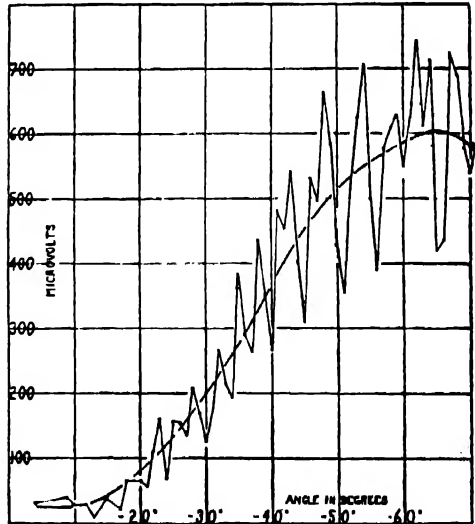

FIG. 10. CURVE SHOWING GAIN OF NIGHTLY FIELD STRENGTHS WITH THE INCREASING DEPRESSION OF THE SUN BELOW THE HORIZON BASED ON UPWARDS OF 8,000 HOURS OF OBSERVATION. THE SMOOTHED CURVE IS USED AS A CORRECTION CURVE FOR ELIMINATING SEASONAL TREND BEFORE COMPARING RADIO FIELD STRENGTHS WITH OTHER COSMIC PHENOMENA.

In utilizing field strength measurements for comparison with cosmic phenomena it has been necessary to apply corrections for the well-known diurnal and seasonal variations which depend upon the extent to which the ionosphere has been illuminated by sunlight during the preceding day. If such correction is not applied, we have of course a marked seasonal trend with a minimum of reception conditions in summer and a maximum in winter. The appropriate correction curve has been derived from over 8,000 half-hourly periods of observations, covering a range of -5° to -70° in the angular depression of the sun below the horizon during the observational periods utilized.

The possibility that an annual or seasonal change exists that is not allowed for by the changing declination of the sun led to the re-examination of all our data of the last few years with the result that a residual annual change apparently exists with a maximum in April and May and a minimum in September

and October. The curve of this residual annual variation strikingly parallels the annual change in the distribution of ozone in northern latitudes as derived by Dobson. The parallelism of these two curves suggests that possibly the cause of the change in the ozone distribution is intimately associated with that of the changes in the ionosphere resulting in this variation in field strengths.

For the pursuit of these studies in cosmic terrestrial relationships a new laboratory for cosmic terrestrial research has been located in the outskirts of the town of Needham where conditions are favorable for radio propagation studies with a minimum of interference, and for observations of atmospheric electric phenomena away from the contamination due to manufacturing in a metropolitan area. The building provides approximately 2,500 square feet of floor space for offices and laboratories. The observational program includes the continuous recording of solar radiation, ultraviolet light, atmospheric potential gradi-

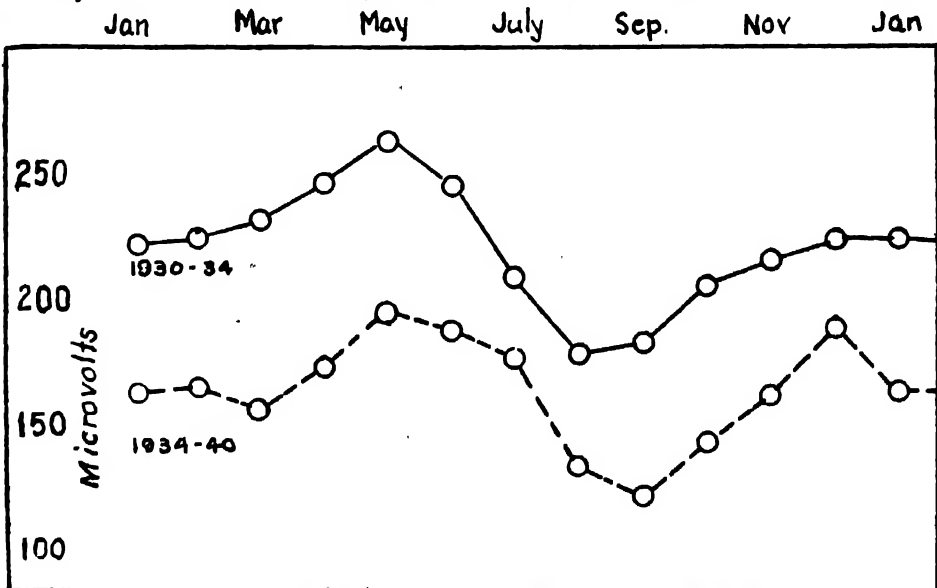

FIG. 11. RESIDUAL SEASONAL VARIATION IN FIELD STRENGTHS OF WBBM AFTER CORRECTIONS FOR TWILIGHT EFFECT OR ANGLE OF DEPRESSION OF THE SUN BELOW THE HORIZON. THE FORM OF THE CURVE IS SIMILAR TO THAT OF THE SEASONAL VARIATION OF OZONE CONTENT OF THE UPPER AIR.

ent, ionic content of the lower air and atmospheric electric discharges, as well as the continuation of the measurements of field intensities of radio waves both in the broadcast band and at high frequencies. The relationship of solar observations, ionization phenomena at high altitudes, and radio wave phenomena to the meteorology of the lower air affords possibilities for extensive investigations which may become of increasing importance.

Attempts to correlate weather changes with solar phenomena have thus far met with varying success. In spite of many conflicting results, it appears that in general the temperature of the world at large is somewhat higher at sunspot minima than at sunspot maxima. This seems at first paradoxical, since we might well expect that at sunspot maxima the sun would send us more heat and radiation than at sunspot minima. Many of Dr. Abbot's observations, especially during the earlier years, seem to corroborate this. Yet the surface temperature of the globe could be actually cooler in years when the earth is receiving more heat from the sun, for increased heat produces increased evaporation which in turn generally results in increased rainfall. Increased rainfall actually lowers the temperature of the earth's surface and again, by evaporation, continues to cool the air immediately above. Furthermore, with the warming of the earth, a vast convectional system of atmospheric currents results. As air warmed near the surface of the earth rises, cold air flows in from the polar regions with its chilling effects. It appears entirely possible that even with an increase in the heat received by the earth from the sun, so far as surface conditions are concerned, actually lower temperatures would occur at selected regions.

So far as changes in the sun's radiation affecting the general circulation of the atmosphere are concerned, it is to be

expected that such changes would ultimately give rise to the formation of storms and the storm tracks resulting. One of the difficulties in establishing any intimate connection between weather and sunspots is that our observations of weather tend to be very local.

If progress is to be made, it will come through a consciousness of the distribution of weather as a whole over the entire globe. From a more accurate picture of world weather, indications for weather in a given locality at a given time may be more easily estimated.

Looking at the weather on a world-wide scale, Mr. Henry Helm Clayton, of Canton, Massachusetts, has found that pressures oscillate from one region to another in some way which appears to depend upon the intensity of solar activity. He finds there is an opposite trend over the continents and oceans in summer as compared with winter, and that the trend is different in the equatorial regions from that in the extratropical belts. In the equatorial regions temperatures are distinctly lower at sunspot maximum and higher at sunspot minimum. The same is true in the North and South Temperate Zones, but in the arid regions bordering the Tropics, the temperature actually averages a little higher around sunspot maximum than at sunspot minimum. From his studies he concludes that while the North Atlantic shows 10 to 20 per cent. more precipitation, the eastern half of the United States is in the region where rainfall is actually less during maximum activity on the sun. He concludes that our weather is the result of certain progressive wave-like movements of certain disturbed areas, originating in different parts of the world. With each cycle of change in solar activity, the centers of high barometric pressure move from high latitudes to low latitudes and back again. The amplitude of their oscillations and the speed with which these

waves progress appears to be inversely proportional to the length of the period of oscillation.

In years of unusually high sunspot maxima, as was the case in 1937, areas of high pressure appear to be pushed farther northward. The return of these highs to low latitudes with accompanying colder and clearer weather may, he believes, be so retarded under such instances as to invert the phase of a cycle that may have persisted for some time while the amplitudes of the oscillations were of less magnitude. Thus there will occur several years when the differences in barometric pressure between the equatorial region and North Temperate Zone become greater than normal, to be followed by several years when the pressure differences become less than normal. The shifting of these centers of action, Clayton believes, is definitely associated with sunspots.

Various attempts have been made to attribute climatic cycles to changes in solar activity. Perhaps the most outstanding scientific contribution in this direction has come from Professor A. E. Douglass, of the University of Arizona, who has spent a lifetime measuring variations in tree growth, especially in the forests of the Southwest and in California. Douglass noted that sequences in periods of rapid growth of trees, as measured by the widths of their rings, follow very closely the sequences in the sunspot cycle. Since variations in tree growth suggest variations in precipitation, he has accumulated a vast amount of evidence for alternations of wet and dry periods variable with the sunspot cycle, carrying records backward for some 3,000 years. His studies appear to indicate that at least for selected regions, trees have shown most growth when sunspots were most numerous. It does not appear improbable, however, that the growth of trees integrates all

favorable conditions and that temperature, the quality of sunlight, and the amount of ultra-violet radiation all enter into the growth rate of trees as well as does rainfall.

Sunspot periods have also been traced with minor discrepancies in the flow of rivers and the level of lakes, some regions responding much more clearly than others to the sunspot cycle.

Altogether we see there are many indications that the earth responds to the changing state of the sun over an interval of a little over 11 years and often by double this period or approximately 23 years. Whether all the effects produced in the earth and its atmosphere that are noticed at sunspot maxima are the result of the sunspots themselves or whether the state of the sun and its whole surroundings are so activated as to change materially the cosmic environment of the earth is a question still unanswered.

In summary, we have reviewed a few of the important ways in which the sun and the atmosphere are closely associated. The solar cycle marked by the coming and going of sunspots appears definitely to be reflected in geomagnetic phenomena of the earth, in the ionization of the upper atmosphere affecting all radio communication, in climatic cycles of the past and in a somewhat complex manner with weather variations to-day. Perhaps some day terrestrial effects yet to be discovered may in turn become predictable through cycles that follow law and order. Difficult as the pursuit of such investigations may be, results already attained are a stimulus to sustained effort, and we are becoming increasingly conscious withal of a more intimate relationship between the earth and its cosmic environment than could have been suspected a decade or two ago. In this cosmic environment we may be assured the sun will play a major role.

PASTEUR: A STUDY IN METHOD

By Dr. FRANCES ROUSMANIERE DEWING

NEWTON, MASSACHUSETTS

I

THE era in which Louis Pasteur made his great contributions has gone by. And when we read of the shambles of the war of 1870 and the mortality in the hospitals then, or meet the present-day conditions in cities of the East where the microscopic is not hunted down, we realize with something of a shock how much we owe to the man who inaugurated that era. I am interested in the question, How did he come to be the one from among the hundreds of students of science in his day to formulate and demonstrate the new theory out of which such successful revision of procedure has come? It is true that conditions were ripe for his discoveries and that we find suggestions for some of them in earlier work. Was it chance and the pressure of his intellectual environment that brought Pasteur to eminence, or is there something uniquely fitted to meet the opportunity in the interests, the capacities, the habits of Louis Pasteur himself?

For a study of this sort we could wish Pasteur were living among us and we might watch and listen to him at work, and that he would have the happy habit of talking aloud to himself. Even then there would be much left out that we need to know. As it is, I have worked with far less, though the biography Vallery-Radot compiled brings the reader unusually close to the living man through quotations from letters, lectures and note-books and the narration of incidents and researches arranged chronologically. From these I have made selections grouped to illustrate the comments that occurred to me during a re-

peated study of the book, believing this to be an acceptable first step toward the full answer of my question.

II

There is no evidence that Pasteur showed any especial ability as a boy or any spectacular ability as a student at the École Normale. Some teachers and one or two fellow students who knew him intimately predicted great things for him. But in his early school days he was noteworthy only as a skilful master of crayons for portraiture. And in the several examinations taken at the École and at the Sorbonne he rated well below the top, though at the aggregation competition he received the comment, "He will make an excellent professor." He set a high standard for himself, took an extra year of preparation for the École Normale when his mark at the entrance examination was a low passing, in order to be better prepared for the work there; and then and always he worked long hours, absorbed in the particular problem at hand.

Two anecdotes suggest that early in his career he made independent judgments. The first, that he took a little volume by a M. Droz on "The Art of Being Happy" to church to read, and commented in a letter to his father, "In spite of all that a thoughtless bigotry might say, I am conforming to the very highest religious ideas." The other is that he spent long periods of his free time manufacturing phosphorus from bones which he himself bought, after the professor at the École had excused the class from the task as being too tedious and had given them a book description of it instead.

Laboratories and experimentation in general were not rated very high then. Only meager arrangements and those often not very comfortable were made for the training of students or the research work of professors. Pasteur on his part was called "laboratory pillar" by his comrades because he devoted so much time to making experiments, though oftenest these were little help toward passing examinations ahead. He carried on this work, too, with such enthusiasm, intelligence and devotion that certain of his teachers became much interested in encouraging him to continue research after school work drew to an end.

III

In those days of training his interest seems to have lain in perfecting his own powers of observation as much as in extending the range of his knowledge of theory. Indeed, one reason he gave in 1884 for choosing his earliest significant research, the study of tartar crystals, which developed into his first great discovery nine years later, was that he would have at hand the work of an authority recently published by which to check his own findings. The check was in the end reversed, for Pasteur found little faces on the edges of some of the crystals which his eminent colleague had not noted, and which gave him the needed clue to an explanation of the variations of effect on polarized light among the different tartars. Here his attitude toward the authorities of his day and the observations he himself makes is epitomized. He respected the first, but ultimate authority rested always with his own experience; and in his observations he was able to see the unexpected almost as easily as that which he expected to find.

This ability to see freshly and so heed what others had overlooked is often a starting point for discoveries throughout his life. He distinguished small globules

present in lactic fermentation not hitherto reported and easily confused with others better known, and using these as ferment was able to show that lactic fermentation is similar to that of yeast. Examining the field where sheep were inexplicably developing anthrax, he discovered the source of contagion through noting something obvious but ignored before, a variation in the color of the ground and a considerable collection of little earthworm mounds in that part of the field which on inquiry proved to be the spot where the carcasses of infected animals had been buried.

He had, too, a habit of very careful examination of everything at hand, carried to the point of some embarrassment for a hostess in his more mature years as he investigated the tiny specks of dust on a plate or glass and wiped them away.

When learned colleagues seemed obstinate in misinterpreting his reports, he fashioned huge wooden models of the crystals under discussion, discarding words for an object to be seen and handled. This at a time when models and diagrams were far less used than at present, so that Pasteur felt it necessary to defend his method of presentation, almost to apologize for it.

Such eagerness to observe persisted rather dramatically in his later years. In 1887 when the family were at Bordighera for his health they were roused one morning early by earthquake tremors. As they left, despite the broken ceilings shaken by constant tremors, Pasteur "observed the effect on glass windows with much interest."

IV

Quite as characteristic as this sensitiveness to what is going on before him was his whole-hearted devotion to the single focus of his energies, devotion to science. His father was a soldier of Napoleon and Louis Pasteur may have thought of himself, too, as a soldier, one

of a group fighting to master the secrets of nature for the sake of better control by mankind. Two sentences in a letter to his father written in 1860, when he was thirty-seven, give this ambition: "At these heights all sense of personality disappears, and there only remains that sense of dignity which is ever inspired by true love of science. God grant that by my persevering labours I may bring a little stone to the frail and ill-assured edifice of our knowledge of those mysteries of Life and Death where all our intellects have so lamentably failed." Though he was deeply moved when the results of his labors helped relieve distress, and even had a certain dramatic feeling for the form practical application might take—"It would be really beautiful to make that agent of disease and death become its own vaccine"—his dominating aim was not the application but the formulation of scientific laws.

It led him in his student days to attend lectures outside his immediate field of work which gave him as a result a background of definitely wider range than that of his colleagues; and the practical questions in insect and animal and in human physiology on which he worked in his later life further extended his field. The resulting body of theory was not a conglomerate of sciences to him, it was an integrated whole, *science*. For instance, he carried over his observations, gained in the work on crystals, of the different reactions to agents of putrefaction of laevo and of dextro-tartaric acid into the study of ferments, and out of that study of ferments developed hypotheses about the nature of contagious diseases.

Pensions awarded for labors accomplished with the expectation that he would be free to rest he took to mean opportunity for more research. We find Mme. Pasteur writing to her daughter in 1881, when Pasteur was nearly sixty and far from well, about a proposed scien-

tific project in South Africa: "Your father would like to take that long journey, passing on his way through Senegal to gather some good germs of pernicious fever; but I am trying to moderate his ardour. I consider that the study of hydrophobia should suffice him for the present."

Pasteur was far from being an austere intellectual. Scientific investigation was an exciting as well as an absorbing pursuit to him. Incidents in his earlier days show the enthusiasm with which he worked, such as his rushing out to embrace the curator walking along the hall as a dearest friend when the test experiment with the tartars was successful. Letters to his family are filled with descriptions of his work so clear that his father became the first of a long line of pupils to catch that enthusiasm and share that excitement over results. Toward the end of his life he writes, "If I have sometimes disturbed the calm of our Academies by somewhat violent discussions"—as indeed had been the case—"it was because I was passionately defending the truth."

His very strong affections pulled him with, rather than against, this scientific interest. Throughout his life he strove not for his own prestige but for the pre-eminence of the country he loved so dearly, sometimes chose a problem to work on because results might lead to higher national standing, and advocated rivalry of that sort as the best expression of nationalism. The force of incentive such patriotic motives gave may be guessed from the instance when the two devotions, to science and to country, came into conflict. During the days of civil war in France the University of Pisa offered him a laboratory and a generous salary, and he replied, "I should feel that I deserved a deserter's penalty if I sought away from my country in distress a material situation better than it can offer me." It was much the same

with his personal affections. By good fortune or good judgment Pasteur chose a wife who like his childhood family attempted only one restriction on his laboratory work, concern for his health; a concern that was justified, especially after the paralytic stroke that interrupted work for three months when he was at the high point of his achievements and still under fifty years of age. With that concern went a devoted and trusted cooperation not only on her part but on the part of the children as well. When it was necessary certain bunches of grapes be carried from Arbois to Paris carefully protected against any contact, his wife and daughter were the ones who in turns carried the bunches upright. For weeks after his mother's death he was unable to do any intellectual work; but later his very grief for the deaths in childhood of three of his five children found outlet in the laboratory where the studies on fermentation were suggesting a means of preventing such tragedy in other households.

Though his deep religious feelings offered no reinforcement, neither did they create any barrier to his studies. The problem of coordinating his Catholic creed with his scientific work he refused to recognize as a problem, and no outside authority pressed it. "There are two men in each one of us," he writes, "the scientist, he who starts with a clear field and desires to rise to the knowledge of Nature through observation, experimentation and reasoning, and the man of sentiment, the man of belief, who mourns his dead children, who cannot, alas, prove that he will see them again, but who believes that he will and lives in that hope. . . . The two domains are distinct, and woe unto him who tries to let them trespass on each other in the so imperfect state of human knowledge."

V

If you had asked Pasteur for an ex-

planation of his success, he might have repeated a comment he once made: "Assiduous work, with no special gift but that of perseverance, joined to an attraction toward all that is great and good." I do not know for what French phrase the last stands. It may fit a reference to this devotion to science better than the translation does. Certain it is that mere quantity of work would not explain Pasteur's discoveries, and that he knew it, for "without theory, practice is but routine born of habit. Theory alone can bring forth and develop the spirit of invention." His notebooks show comment, interpretation, suggestion of correlation entered one day and oftenest marked "erroneous" a little later, and there are found very early intuitions of the far-reaching hypotheses he long afterwards established.

But no fairy tale of clever imagining was enough. The scheme must of a surety fit the reality. And to be sure his theories did fit he planned and carefully executed experiments such as allowed of definite and convincing interpretation. The experiment with hens and anthrax gives a simple but quite perfect example of the sort of demonstration he wished. The birds were thought to have a special immunity toward the disease because they did not contract it. But Pasteur evidently doubted that and asked himself what if any physiological variation from animals they might have, for he tested the effect of their high temperature upon their susceptibility by putting one in a bath and again trying inoculation. This time the hen was sick, though another hen, also kept in the bath but not inoculated, and a third, inoculated and left to run about, both were well; and removal from the water was furthermore found to effect a cure. Not a special immunity explained the situation, but the blood temperature. This interplay of experience, imagination and rigorous analysis Pasteur calls the ex-

perimental method, and he repeatedly holds it up as an ideal. "We have experiments to straighten and modify our ideas, and we constantly find that nature is other than we had imagined. They who are always guessing, how can they know?" "Never advance anything which can not be proved in a simple and decisive fashion," he preached over and over again; though, as he once warned a group of young students, "what I am now asking you . . . is what is most difficult to an inventor . . . to constrain yourself for days, weeks, years sometimes, to fight with yourself to try and ruin your own experiments and only to proclaim your discovery after having exhausted all contrary hypotheses."

He did not forget a dissenting observation or rest satisfied to label it "exception" even after he grew confident of the fundamental truth of a theory. Sometimes it was years before he could clear the matter up, as in the case of the wineflower, which for so long a time seemed under certain conditions to turn into a quite different germ no matter how careful the technique used. Finally, after months of work Pasteur was able to construct a complicated apparatus by which he succeeded better in keeping germs from falling into the liquid from the air during his experiment, and alcoholic fermentation occurred no more. He could at last show that the wineflower did not change to an alcoholic ferment, but that the germ of such ferment had been added from the air, and that the wineflower, like all other germs known to him, was specific. In making such experiments Pasteur carried the finesse of tests to a much greater development than it had been carried before. Precautions for asepsis with which even the layman is somewhat familiar to-day (little things such as the temperature to which a container must be heated, higher than that the contained liquid requires) he came to by a process of trial

and error from his own need for explaining seeming failures and developing impeccable methods.

Even after he was ready to proclaim a discovery there were the objections of opponents to be met. It took only three years of work to convince Pasteur that no such phenomenon as spontaneous generation occurred, but objectors repeatedly announced results that seemed to refute him; and in 1875 he writes with reference to a set of experiments announced from England: "For nearly twenty years I have pursued, without finding it, a proof of life existing without an anterior and similar life. . . . Whenever I hear that this discovery has been made, I hasten to verify the assertions of my fortunate rival. It is true that I hasten toward him with some degree of mistrust, so many times have I experienced that in the difficult art of experimenting the very cleverest stagger at every step, and the interpretation of facts is no less perilous."

In the effort to satisfy first himself and then his colleagues he dwelt with these problems constantly, and speaks of "sleepless nights" spent working out a simple formulation or a crucial test. The energy time expended was very great indeed. It is no wonder he himself emphasizes "assiduous work" involved in that experimental method.

VI

If we press our point a little harder, insisting that what we wish to learn is how it happened new interpretations of facts or new methods for tests occurred to Pasteur, we may do well to look a little more closely at details of his work.

For one thing Pasteur had the practice of seeking comments as well as observations where many would have ignored them. "Nothing should be neglected," was his rule; "a remark from a rough laborer who does well what he has to do is infinitely precious." He began a new

problem, first by mastering what was written on the subject if it were a new field to him, but next by questioning the people who were in day-by-day touch with the source material, silkworms, sheep, beer, pigs. Their guesses might suggest to him some more sophisticated guess of possible lines for laboratory experiments.

For another, he did not let his own distrust of success interfere with any research. At times this meant that he made a discovery against his own surmises, as with the transformation of tartaric acid into racemic acid in 1853, when he wrote his father: "Here is at last that racemic acid (which I went to seek at Vienna) artificially obtained through tartaric acid. I long believed that impossible. This discovery will have incalculable consequences."

His very thoroughness, too, led sometimes to rewarding surprises such as he might not have thought to work for directly. For instance, during his attempts to become quite certain by watching its action under every condition that the wineflower mentioned earlier either did or did not turn into an alcoholic ferment, he came upon a phenomenon new and very important to him, the change of life of the little fungus when submerged. This led to the investigation of other fungi for a similar characteristic, and from those studies to the dictum, "fermentation is life without air."

Again, though theory of some sort was, so he held, always to be sought, facts held the ascendancy of power over any specific theory. Even well-established ones were not inviolable in Pasteur's eyes, not "fixed ideas." He was not afraid to study the possibility of spontaneous generation, though revered teachers warned him against its "obscurity," or to break into the conferences of medical men with his heresy of specific germs for disease; and he was definitely impatient with those col-

leagues who held to the teachings of their youth when shown experiments that could be explained only by a revision of those theories. As a person Pasteur himself had a sturdy self-respect that gave him dignity in any company, and for him facts had a corresponding dignity as facts in the presence of any given theory, however authoritatively backed. Such absence of rigid presuppositions freed him to imagine, much as he was free to perceive, the new and unexpected.

VII

Yet he was not blown hither and thither by each new difficulty or new surmise. "It is possible, but we must look more deeply into the matter," is a characteristic response. And though with him all theories were open to challenge of new facts, some were much more firmly entrenched than others. When a brood of silk-worms hatched from should-be healthy seed turned sick and pined away quite as those infected with pebrine do, Pasteur did not throw over or even question the method of selecting seed which he had so thoroughly tested, but patiently studied the dead worms for signs of some other difficulty, till his faith in the method he had so carefully developed was vindicated by evidence of another disease, flachery, in the brood.

In a time when arguments from and by *a priori* theories were so general, this insistence on the significance of cool evidence in discussion must have been a great contribution to the development of the biological sciences, particularly the applied fields; though the fervor with which Pasteur pressed such need perhaps makes the term "cool" inappropriate. He recognized a place and a use for the unproved speculation also, however. It must not be proclaimed or affirmed, by which he means, I think, urged upon others; but it is a natural and unavoidable development of human response to experience and may serve as a search-

light in research. A letter to his opponent Pouchet gives one of these aspects: "I think you are wrong, not in believing in spontaneous generation (for it is difficult in such a case not to have a preconceived idea) but in affirming the existence of spontaneous generation." And an entry in his note-book made during the civil war of 1870 gives another. "I could write that letter to Bernard. I should say that being deprived of a laboratory by the state of France, I am going to give him the preconceived ideas that I shall try to experiment upon when better times come. There is no peril in expressing ideas *a priori* when they are taken as such and can be gradually modified, perhaps even completely transformed, according to the result of the observation of facts."

It was not the strength of one's own belief that marked this distinction between doctrines properly or improperly affirmed though; it was the absence or presence of convincing objective proof. "When we see beer and wine subjected to deep alteration because they have given refuge to microorganisms invisibly introduced and now swarming within them, it is impossible not to be pursued by the thought that similar facts may, *must*, take place in animals and in man. But if we are inclined to believe that it is so because we think it likely and possible, let us endeavor to remember before we affirm it that the greatest disorder of the mind is to allow the will to direct the belief."

VIII

What I have to say now in conclusion I offer as belonging to that class of beliefs which Pasteur considered personal, suggestive only, and waiting to be modified or confirmed by further research. First, as I see it, we should remember that much of the detail of method noted in the preceding paragraphs is worked into the current techniques of to-day and it is easy to underrate its significance in

the work of Pasteur's time. The very fact of his early interest in laboratory work, his great thoroughness in the development of checks and tests and in trying out all contrary possibilities and so on, bespeaks a stronger inherent interest in him than it would in a present-day student, to whom such work is part of an accepted routine. It is that concern to get and keep in close first-hand touch with his subject-matter that is one of the most outstanding aspects of his life; and we must consider "subject-matter" to cover all experience. The purpose that was strong enough to make him see what others overlooked and to "fight with oneself" for complete evidence in chemistry, mineralogy, biology, served also to cut through personal rivalry and vanity, traditional teachings and individual preoccupation with scientific work to a very full awareness of what actually went on in his own life as well as before his eyes. It was very deep in him. All the words I have used, interest, concern, purpose, imply a consciousness on his part of the rôle he was playing, which is hardly true. This eagerness for and openness to actual experience was, it seems, as natural as breathing for him.

In some ways, Pasteur may have been particularly fitted to contribute to the science of his generation where microscopes could help him actually to see the objects he studied. It may be he would not have been so much at home where elaborate formulas and inferences to the submicroscopic were needed. It is certain, too, that the warmth of his nature found satisfaction in the humanitarian aspects of his results, and though he considered those secondary to his main work, the theoretical, the fuller satisfaction may have made possible his very complete absorption in his researches, without the friction of restraint, which study of a more abstract set of problems could not have done.

Yet on the other hand he was so flexi-

ble, so open-minded, so objective, apparently, toward the new and unexpected that we feel he would, given the evidence, have quickly adjusted himself to advancing theory in any age. Wonder, almost awe, he seems to have felt as his own work developed, but we get no note of resistance to an hypothesis because it was startlingly new. The resistance was developed in his eagerness to escape being duped, to reach a real, not an imagined, world.

From what we know of him through his note-books we have reason to believe ideas came to him thick and fast. The labor he speaks of has to do with modifying them and weeding them out. Pasteur was, it seems, as concerned to get order into his experiences as he was to be clear-eyed in meeting them. And this again was a concern so deep in his nature as to call for no conscious direction on his part. He sought theories that should not only adequately explain experiments, but be so adequate as to include finally even seeming exceptions and phenomena wide-removed. The world of fact, of experience, dominated his interests, but not as a passing show. He sought to find organization there, to give it shape. Certain of the quotations chosen show how deep was his desire for order, for careful distinctions and classifications, even in fields quite outside his technical research; and Vallery-Radot tells us he felt poignant and lasting regret for the interruption set to a thor-

ough study he had planned into the importance of dissymmetry in the general structure of the universe. I have noted how discovery in one field was carried over as a basis for hypothesis in another.

The difference between Pasteur's method and that of others seems to be a matter of degree, longer hours perhaps, deeper concentration, more acute observation, less constraint of tradition on imagination, a more persistent drive to discover wide and wider relationships and a more rigid search for flaws and more thorough examination of possibilities. We come near repeating ourselves as we name over different aspects of scientific work. But there is one other characteristic which the biography makes vivid to me and which I gain from the life as a whole rather than from single quotations. Pasteur had himself well in hand. He could weigh evidence without letting his desires get into the balance; he could fight with theories without being personal toward the men. He had a kind of glorified self-consciousness and could keep the primary and the secondary in his life clear of each other, and as he worked was aware of the varying basis for actions and for beliefs. Here again he was carrying to a further state of development something true of all scientists to some degree; but there are times when a difference of that sort becomes a difference, too, in kind, as when water growing colder turns to ice.

THE SCIENTIST AND SOCIAL POLICY IN THE DEMOCRATIC STATE

II. SCIENTISTS HAVE RESPONSIBILITIES

By Dr. CHARLES E. KELLOGG

PRINCIPAL SOIL SCIENTIST, U. S. DEPARTMENT OF AGRICULTURE

THE majority of people in our culture, including many scientists, have seen no pressing need for national and international planning. Haven't things been going along, generally getting better, they say, without it? Certainly the highest civilization ever known, as measured in terms of the material living standards of the average family, has developed in America. Since human nature is the same,¹ they say, and since cultures must have "growing pains," a few depressions and wars are inevitable, but after each we have emerged stronger than ever. The other arguments are familiar and need not be repeated.

True, certain individuals had predicted a calamity if more positive actions were not taken to fit the various pieces of our civilization together, but their predictions failed—we haven't fallen apart—not yet. In England and America, at least, we have always been able to "muddle through" somehow—and, many say optimistically, we shall do so again without a lot of fuss over planning.

What has given rise to this optimistic faith in the future? Perhaps much of it grew out of Christianity: whether in this world or another, man could look forward to something better. In fact, the whole of western culture is permeated with this interest in the future. Perhaps this common faith in the future on the part of scientists, religionists, socialists and capitalists is of greater significance than their differences. During the eighteenth century, however, many people became very pessimistic

¹ If this were true we would still be in caves with clubs, all of us.

about the future. Population in Europe was increasing more rapidly than the food supply, or so it seemed. Near the close of the century Malthus wrote his famous essay. But the two great movements which he did not foresee had already begun: the rise of science and the expansion of trade and colonization into new lands. Through the application of science in agriculture yields of food crops were greatly increased in Europe, and colonists from Europe brought millions of new acres into use.

To most people science reinforces their faith in the future. As technological developments began, there seemed to be no limit. Each day, almost, one might expect something new. Then, regardless of what Darwin or other biologists have said, the great mass of people think of biological evolution only in one direction—upward and better. This faith in the future and in progress reached enormous heights in America, especially among city people, but also among many farmers as well. On every side things were "bigger and better," and "booster" clubs cried "watch us grow."

At least superficially, it does seem that the individual of to-day (January, 1941) has more, sees more and endures less physical pain than his ancestors. It is not surprising that people have acquired a great faith in science and feel no need for broad planning when so much has been done without it. But a very special circumstance permitted these developments: the rise of science was accompanied by the discovery of vast new lands.

During the period of growing political

freedom, when science was revolutionizing everything, all the minutiae of our daily lives and many of our fundamental ideas as well, there was a great outlet for pressures within the culture when they developed. From the discovery of America until after 1890 there were millions of acres of fertile soil, and an abundance of other natural resources as well, to be had for the asking and taking. This free land in the Americas, in Africa, in Australia, and elsewhere, provided a place for the adventurous, the discontented, the unhappy, the frustrated and the misfits. People from Europe had a place to go—a good place where the land was productive. Of particular importance was the fact that much of this new soil was similar to, or not greatly unlike, their own. They could build new homes, without completely changing their old habits. Near the end of this period, as northern Europeans have pushed into the dry regions and the tropics, more fundamental changes have been required—adjustments that have yet to be worked out satisfactorily.

Such an escape for more than three centuries had an unusual influence on western European culture and upon the civilization developing in the new world itself. There was not only room for an expanding population but an escape for those with new or unconventional ideas. Many came to the New World or went West, to escape public criticism or even imprisonment. The old society was thus easily relieved of the responsibility of making adjustments for these people and the adventurous found a place where they might begin a new life. Everything cooperated during the eighteenth and nineteenth centuries to produce change and to spread the European stocks over contrasting landscapes where differences in ways of life were essential for existence. And all this could be done without any extensive provision for

social planning because the new land was free.

Talk about a relief program! The world had never seen the like before nor will likely ever see it again. Had it not been for this possibility for expansion, certainly our civilization would have been entirely different. Provisions would need to have been made for those groups who escaped to the new lands. Great industrial centers could not have been built from raw materials grown on cheap land. "Muddling through," as a public policy, simply would not have worked and would have been thrown out long ago in favor of some kind of conscious planning.

The process came to an end in the twentieth century—with a bang in 1914—and we are late with planning. Since the advance guard of the expansion had been agriculture, farm people were hit first—but the shock soon spread to every one, inevitably. The industrial life of America and Western Europe had also been built upon an expanding economy. Now people are piling up where they are. The new farmer to-day starts on expensive land. Others producing raw materials are in essentially the same position. Methods of exploitation that do not provide for secure production—continued production in the future—lead to disaster for those who can not move on to free land. Thus suddenly the social group is forced to make adjustments within the present area, and do so while there is time.

OVERLAPPING PATTERNS

The recent emphasis upon the synthesis of scientific facts and principles with human values in the social world has brought fundamental changes in the philosophy of science itself. The classical scientist gave great emphasis to order and system. Each field of knowledge must be minutely outlined; and the facts, as well as the principles drawn

from the facts, were carefully classified. Although one can not deny the need and utility of classifications, they may become—frequently have become—static, and inadequate for guiding the application of knowledge to broad problems.

The static concept of order and system held by the classical scientist is giving way, slowly, to a dynamic concept, in which the *relevancy* of fact is as important to truth as fact itself. To the question, "Is it so?" is added the further question, "So what?" A fact of vital importance in one time or place, in one set of relationships, may be relatively insignificant in another time or place. The significance of any of these relationships is not to be had by the simple addition of facts or principles from different systems of classification.

The properties of hydrogen and oxygen do not "add up" to those of water; this substance has properties that grow out of the relationships between the two elements. In other combinations, such as oxygen and calcium or hydrogen and chlorine, they act differently. Thousands of different compounds—solids and liquids, foods and poisons—are composed of the same elements, carbon, hydrogen and oxygen, but with different patterns of relationship. Even more obviously, the distinctive features of a painting depend upon the arrangement of the figures and pigments, upon the pattern. They can not be defined in terms of static physical and chemical classifications.

Let us carry the example forward into the field of geography. Separate classifications of rocks, soil texture, slope, soil depth and all the other characteristics of the soil do not "add up" to a soil classification. Soils—soil types—must be defined as particular combinations of characteristics, in which any one characteristic has a particular relevancy. In one combination, a difference in slope or acidity, may have great significance; in

some other combination—some other soil type—it may have none. Then, given a proper soil classification useful and adequate within its scope, one can not get a land classification (using land in its broad cultural and physical sense) by adding to it classifications of present land-use, cover, water power sites, marketing facilities and the other features that are somewhere relevant to the use of the land for production and as living space. The distinctive features of landscapes arise from the relationships among these many individual characteristics. Their usefulness to people and their fitness for social groups depends also upon the relationships among the elements of this pattern and the cultural notions—changing ideas, traditions, laws and institutions—of the social group.

This dynamic concept of science in respect to a changing world leads one to the appreciation of a great many overlapping relationships. A new technique in production, for example, changes the relative advantages of different kinds of land, different trade routes and different skills. The new method may solve some old problems, but create new ones with which people have had little or no experience. The requirements or influences of the new methods may conflict with older views of taxation, organization and social responsibility. Thus, gradually, an old virtue may even become a new crime.

We may think, for example, of labor, of agriculture and of business, or of investors, managers and workers. We may think of the East, the West, the South and the Middle West. We may think of conservative people, those who are ultra-conservative, the liberals and the radicals. We may think of the automobile industry, the radio industry, and the transportation system. But the same person, the same skill, the same idea or the same place may fall in several such groupings. Many people are both work-

ers and investors; there are farmers in all sections. A person classified as a liberal or a radical from the standpoint of civil liberties may be a conservative on questions of federal control of business. Strong advocates of liberalism in government may support with equal vigor the bureaucratic, undemocratic management of trade unions, corporations or individual governmental agencies.

People, regions, machines and skills belong in many overlapping categories. They can not be put into any one system; and even if they could, they would need to be shifted to-morrow. Ultimate completeness of system and classification is impossible. The newer dynamic concept of science denies the possibility of complete systems and fundamental causes. Scientists know now that there are many laws and many causes.

Those kinds or stages of scientific activities in which emphasis is upon discovery and description have been and can be conducted fairly well within the framework of subject-matter disciplines, like botany, chemistry and economics. A great deal can be gained, however, through cooperation among investigators and through the broadening universe of individual scientists, particularly as attempts are made to solve practical problems or to discover principles necessary for their solution.

In the invention stage or kind of scientific effort, a great deal more emphasis may be laid upon an appreciation of the world outside the special science. Much that is invention hardly involves science at all; it is rather art. The distinctions between art, industrial art, applied science and fundamental science are all very broad, indefinite lines. But some kinds of invention at least require a very detailed knowledge of scientific principles and their relationships. Whether or not the term scientist should include the user of scientific principles in invention and planning as well as the funda-

mental searcher for new principles is unimportant. Some would call the others planners or technicians, and reserve scientists for those engaged in fundamental science. It seems more appropriate, however, to regard as a scientist one who uses the scientific method and scientific principles, whether to discover new principles in science, new things or to understand relationships.

The planning stage or kind of scientific activity requires the fitting together of principles from many disciplines. Not only is the relevancy of the scientific principles in respect to one another important, but also emphasis must be given to their relevancy in relation to principles of morals and justice and of social values. And this must be done with no lowering of scientific standards. Too many so-called planners avoid their problem by oversimplifying it. The oversimplification of a problem, that is, bringing the problem down to the level of the planner, of course leaves the real problem still unsolved. The great need to-day is for the organization of attacks on the broad problems of great social significance so that our best and most detailed scientific knowledge may be used and the principles of science properly applied in respect to other principles. This must be done without "vertical" oversimplification through overspecialization in terms of a single discipline on the one hand, and without "horizontal" oversimplification through careless, superficial generalization on the other. And done while there is still time.

SLOGANS

Perhaps as a heritage from classical science, many folk still look for some fundamental cause, some one cause with some one panacea. The panacea is set into a slogan that is simple and easy to remember and repeat, one intended to electrify all human minds, set them on a

single course and put the social organism in order.

The modern problem of the slogan is becoming enormous. The technique has been studied and developed by all sorts of persons and groups, including politicians, advertising "experts," social reformers of both the left and the right, civic boosters and even organizations for charity. Although the principle is dangerous, all slogans are not necessarily bad. And they can't be eliminated by pressing for a new slogan, "Down with slogans."

In times past they have been useful where a fundamentally worthy purpose could only be achieved through mass action. At first the slogan may be simply a catch phrase to attract attention or suggest an idea, then a rallying call for leading a mass of people toward some objective, perhaps good or perhaps bad, depending on one's point of view, and possibly later it may become a rigid, over-simplified doctrine or article of faith to which all other ideas must be subservient. In this last stage it may lead to an extreme over-simplification of a complicated problem, and to merciless exploitation through rejection of other ideas of importance to human welfare, even under a banner that sounds good and simple by itself.

One has only to recall the famous slogan of the French, "Liberty, Equality, and Fraternity." Enormous forces for liberalism and democracy were marshalled under it for over a hundred years. (Many undemocratic acts were also done under the same banner, especially in the early years.) Yet perhaps its mere repetition led to a sort of lazy confidence in some mysterious force within the slogan itself, regardless of what people did or thought. The basic trouble is that thinking is difficult and the slogan offers a substitute as well as a rallying cry. Any substitution for thinking, whether developed as a slogan

or in some other way, spells doom for social organizations conceived on liberal and democratic lines, whether governments or other sorts of organization, say of farmers, of workers or of scientists within the state.

As long as the democratic state remains in fact a democracy, the slogans of one-idea enthusiasts and pressure groups come into open conflict and can be discussed and compromised. Yet this is not always easy, even in a democracy. Frequently groups outside the government, or even within the government itself, may work under a beautiful slogan, under a statement of principle with which nearly all agree, yet work quietly for some more immediate selfish purpose. Sooner or later the ruse fails, the public awakens to the real situation. In many such cases the public reaction goes too far and throws out the good in the idea along with the unworthy who worked under a false banner.

Many times have the people been fooled, for a time, by misguided enthusiasts or selfish exploiters working under a banner of "prosperity," "security," "conservation," "health," "education" or some other worthy objective. If some one objects to what is being done, he may be identified with reaction and greed or dismissed as a quibbler. (The modern meaningless word of condemnation is "unrealistic." To the person who uses this word, all ideas, other than his own, are "unrealistic." Then there is a whole series of other words, similarly undefined, to apply to one's opponent in ideas—Communist, Fascist, reactionary, Red, etc., etc.). Yet there have been many times when the sincere and informed supporter of a worthy cause must take a stand against certain groups parading under a slogan for the cause, that is, he must if he is loyal to his responsibilities in the democratic state. If scientists lose their courage to do this, they will fail their fellow citizens; and

in this modern world democracy will be doomed.

Above all must scientists be depended upon to warn against the chimerical panacea. The problems of agriculture, for example, can not be solved by driving along any one course summarized as "attainment of parity prices," "every farmer an owner" or "save the soil," along with "production for use," "national planning," "grass-roots administration," "the American market for the American producer" or any one of a dozen other slogans. Each slogan may have a large element of merit and each may indicate the direction of a partial solution to a pressing problem. They are good if they stimulate thought and awaken interest. They are bad if they discourage thought. Each one could become a vicious, exploitive idea if overdone in respect to other vital considerations. Scientists have responsibilities to explain the relationships and inadequacies of these slogans and keep them from creating more problems, and worse problems, than they solve.

A close relative of the over-simplified slogan, so characteristic of our age, is the either-or complex. The world may have a few blacks and whites, but most of it is made up of grays. Central planning isn't completely right or wrong; nor is the idea entirely new or old. The government doesn't need to choose between no credit to farmers or householders and unlimited credit. One can not say that a certain type of soil or land is definitely productive or unproductive, in the abstract. Only in reference to particular sets of relationships can a degree of productivity be suggested. Some acts may be always wrong and some may be always right, but most are right in some situations and wrong in others.² Yet all

² Not long ago I received a letter from a professor in a great university listing several practices of farm husbandry, including the construction of terraces, the use of fertilizers, the growing of legumes like the clovers, and several

the time scientists are being asked, we are all being asked, to fill out forms with instructions "to check either one or the other."

Certainly scientists should be aware of the inadequacies of slogans, and should not be misled into "either-or" divisions such as, for example, the recurring question of whether the scientist should be "theoretically correct or practically sound," as if there were such a conflict. Those who are really scientists, those familiar with the use and application of the scientific method and trained in objective scientific criticism, must be depended on to object and to explain. They must enlarge their universe of examination and criticism, if they are true to their responsibilities as citizens as well as scientists. Courage will be required—courage to make mistakes and admit them. May they develop this courage and assume their share of responsibility while there is time.

SCIENTISTS AS MEN

It has already been assumed that scientists have responsibilities as citizens and that they are human beings much like other folk. Scientists are born, educated usually at public expense, fall in love, go to the movies, drive cars, pay taxes and do all the other things that other folk do. They have no special immunities during periods of social crises, as has been shown time and time again. After being congratulated and receiving the praise of a sympathetic society (along with a fair measure of self-congratulation) they were probably the most confused segment of the population when the bubble burst in 1929.

Many scientists have accepted an others, and he asked me to check which *one* he should recommend for soil conservation in the United States in a book he planned to write! Of course, each may be good in some places, when done properly with others, and each may be indifferent or perhaps even very harmful in other places.

amazing dualism. They live in two worlds; their work is one, and their ordinary life is another. It is truly remarkable how they separate this work-a-day world in which we all live from their scientific world. The separation even extends to their fundamental concepts of philosophy and logic. The critical faculty employed so carefully in the laboratory, in field work, or in the library may never once be applied to other judgments—even to modern radio and magazine advertising. Although advertisers of scientific apparatus in scientific periodicals are very cautious in their claims lest they irritate the scientists, the names of the same scientists are regarded as an excellent "sucker list" for all sorts of other things!

Does a scientist fundamentally change when he goes to the movies, or enters military service, or supervises the education of his children, or seeks a remedy for a head cold, or walks through a labor picket line, or considers the qualifications of men for public office, or realizes he is broke? Is the scientist, after all, a sort of robot whose training and thinking are confined entirely to one small portion of his nervous system that has no relation to the rest of it? Of course not, but sometimes it seems so.

Perhaps this lack of awareness is not unique among scientists. Yet we have a right to expect more from them. Not only is democracy essential to progress in science, to the discovery of new ideas, new principles and new patterns, but the scientific attitude is essential to democracy. Between anarchy on the one hand and strict authoritarianism on the other, between the irresponsible skeptic and the unreasoning dogmatist, is the place of democracy and scientific reasoning, based upon evidence and logic, supported by faith in people and the dignity of the individual. Without this attitude democracy is doomed, science

is doomed. Applied science, scientific technique, may flourish for awhile under autocracy, but not for long. The well of ideas and principles developed through the use of the scientific method in research soon runs dry.

It would be difficult, if not impossible, to over-stress the importance of this mutual vitalization of science and democracy. As citizens of a democratic state scientists have many privileges, not the least of which is that freedom for work and expression essential to science. But these are not privileges to exploit their fellow citizens or allow others to do so unchallenged, through the use of scientific skills and jargon. People have developed a great faith in science—a faith so great that the modern scientist has a staggering responsibility, not as an autocrat, not as some kind of high priest, but as a man and a citizen with special functions, like others with special functions in the democratic state. Any scientist who accepts the privileges and shirks the responsibilities, especially any scientist who attempts to use the people's faith in science to mislead them through falsehoods for his own personal gain or aggrandizement, is a serious enemy of the democratic state. Many may do so unwittingly. They may not be unpatriotic according to conventional standards, are even willing to join the fighting services if necessary, but they are unaware of the implications of their activities as scientists in a world of men.

For another citizen to avoid his responsibilities may be bad also. A farmer may allow his soil to become depleted for future use, because he doesn't know what is happening, or perhaps he doesn't care. A factory owner may permit conditions that ruin the health and happiness of his employees because he doesn't know or care. But for scientists, who have had great educational advantages, largely at the expense of some one else,

who have had the great privileges of learning the methods of science in a democratic state, to do likewise is many times worse. And they need to learn their responsibilities and accept them, not simply as an idealistic gesture in a sinful world, but as a vital matter of preservation for themselves and their children.

Our educational system in science, during and after college, may be partly to blame. We teach young scientists to become members of a group—a clique. We have societies for chemists, for geologists, for botanists, for economists, for anthropologists—indeed for about every conceivable breakdown of human knowledge. They may be good if not carried too far—but it appears that we have carried them much too far, in college among both faculty and students, and after college. Too much introspection is not good for either individuals or for specialized groups. They tend to become pressure groups for this or that, and especially for their self-interests and self-glorification. This kind of thing leads our young scientists away from other branches of knowledge, away from other values, away from people and away from democracy.

The scientific method needs to be taught and used as an everyday tool of living men, not simply as a special instrument for the laboratory to be locked in its case while the scientist is away from it. Few of our schools and colleges have even begun to realize the great educational value, as contrasted to the purely technical value, of the scientific method. The scientific method isn't just measuring and sorting and observing under controlled condition; it is also evaluating the evidence, arriving at tentative conclusions, criticizing these and other conclusions, and gradually improving our knowledge, gradually gaining a step toward truth.

These same processes of thought are essential to democracy. Ideas, prejudices and relationships must be studied objectively, evaluated, reshaped and fitted together so the ends of democracy may be realized and its processes kept vitalized and meaningful to the individuals who are counted upon to support it. These processes are controlled and operated by the citizens, by men. Among these scientists, as men, have great responsibilities and much work needs to be done now, while there is time.

THE RELIGIOUS FORCE OF UNIFIED SCIENCE

By EDWARD F. HASKELL

UNIVERSITY OF CHICAGO

If you should ask a member of a truly primitive people to explain his religion, and he could be made to understand your question, he would find it absurd. He would find it so for the same reason that we would find the following request absurd: "Define the universe and give an example."

Concrete instances of the world views of primitive peoples are furnished us by my neighbors, Lloyd Warner¹ and Radcliffe-Brown,² of the University of Chicago. They have lived on a close, friendly basis with the Murngin and Arunta, naked black peoples dwelling in the isolated wildernesses of Australia.

The life of an Arunta or a Murngin man is, in his own view, an exact cycle: The first life crisis occurs when his spirit, through a mystic experience of his mother or father—not a physical act—leaves the totemic well—an actual, visible spot in their country—and enters the womb of the mother. By circumcision around the age of seven he passes from the social status of children and women to that of men. When at around the age of eighteen he achieves parenthood and is shown his totems for the first time, he goes to another, higher status; and to a still higher when, at about thirty-five, he sees the high totems. At death he passes through an elaborate mortuary rite, returns to his totemic well. Some day the Arunta man will, he believes, come forth from his totemic well and be born again,

¹ W. Lloyd Warner, "A Black Civilization." New York: Harper Brothers, 1937.

² A. R. Radcliffe-Brown (formerly of the University of Chicago), "The Social Organization of Australian Tribes." London: Macmillan Company, 1927. Baldwin Spencer and F. J. Gillen, "The Arunta." London: Macmillan Company, 1927.

as he has been many times before. He will be one of his own tribesmen, possibly his own grandson or grandnephew, and will have the same totem that he has always had, and keeps on having even in the periods when he is being dead. And so on forever and ever.

As far as an Arunta or a Murngin can see, no one, and especially no people, can possibly leave their country with its indispensable totemic wells. Obviously such a thing could not be, for how could he or any one else be born? How could there be any people? And how could there be animals and plants either if people did not perform rituals at their totemic places? For an Arunta the idea of life going on without the life cycle around the totemic places is as absurd as would be for us the idea of life going on without the earth's cycles around its axis and the sun. The Murngin's and Arunta's idea of the human organism, of animals and plants, of terrestrial regions and celestial bodies is integrated with the idea of their own societies. Their every act is moulded by this idea. I should say that their world-views are far more internally integrated and far more integrated with their and their people's thoughts and acts than is the world-view of most of the people you and I know personally. Similar observations on many primitive peoples besides the Arunta and Murngins have led to the early, only partially valid anthropological law that a primitive society is a sacred society.³

Continued observations and analysis, however, seem to show that it is not the

³ Emile Durkheim, "Les formes elementaires de la vie religieuse." Paris: F. Alcan, 1912.

primitiveness of a world-view *per se*,⁴ but its integration—a condition usually, though not exclusively, associated with primitiveness—which is constantly associated with religiousness,⁵ with serene confidence in the world and the future, with mental security and peace, with uncompromisingly social behavior. The integration of physical, mental and social states, reified in daily action and symbolic rites, results in configurations whose force, transcending and subjugating all other human configurations, I call "religious force."

To-day this religious configuration is to be found in a few really primitive peoples, such as the Murngin and, among others, in some Catholics, some fundamentalist Protestants, and in some of Nazi youth⁶ and most of Soviet youth. These men's whole personalities are integrated through uncompromising, brave, self-sacrificing action. The super-organisms⁷ which these people collectively comprise are integrated by universally held goals and ideals, not sterilely believed, but effectively expressed in mass demonstrations, rituals, and labors.

Even with inferior resources and techniques religious super-organisms have in the past and do to-day dominate non-religious ones. Clearly, then, when I speak of religious force I do speak objectively of a natural force that can be observed and felt in oneself and in others, in individuals and in super-organisms.

This being the central point of my presentation, let me repeat that peoples who act in accordance with integrated

⁴ Franz Boas, "The Mind of Primitive Man." New York: Macmillan Company, 1938.

⁵ Ruth Benedict, "Patterns of Culture," pp. 21-23. Boston: Houghton Mifflin Company, 1934.

⁶ W. Hauer, K. Heim, K. Adam, "Germany's New Religion." New York: Abingdon Press, 1937.

⁷ Alfred E. Emerson, "Social Coordination and the Superorganism." *The American Midland Naturalist*, Notre Dame, Ind.: The University Press, 1939.

world-views have the following vital characteristics in common: they have deep faith and strong confidence in their world and their future, and their respective communities exhibit extraordinary unity, direction, and power. Since all the above-mentioned peoples exhibit these important characteristics, and since no people whose world-views are not integrated exhibit them, I call not only some, but all, of them *religious* views; and the force not only of some, but of all, *religious* force.

II

All words, and among them "religion" and "science," are materials with which we think. If we are to build an efficient world-view these unit words must correspond to important unit actualities.⁸ For us, important actualities are mental peace and united, powerful, efficient action. For the sake of effective thought, therefore, the word "religion" should apply to integrated, universal views, whatever their logical categories and not, as at present, be artificially restricted to views which include man-like, anthropomorphic gods.⁹

The notion of two contrasting entities, science *and* religion, is harmful to modern civilization: It leads to fruitless preoccupation with pseudo-problems such as the lengthy discussions, in churches and philosophy classrooms, of the supposed conflict or harmony between science and religion.¹⁰

It is harmful, further, because it constitutes an impassable barrier—for the period of its duration—between deeply emotional, socially useful world-views of

⁸ Edward F. Haskell, "Mathematical Systematization of 'Environment' 'Organism,' and 'Habitat,'" *Ecology*, January, 1940.

⁹ Gerald Heard, "The Social Substance of Religion—an Essay on the Evolution of Religion." New York: Harcourt, Brace and Company, 1931.

¹⁰ John Dewey, "Unity of Science as a Social Problem," *Encyclopedia of Unified Science*, Vol. I, No. 1. Chicago: University of Chicago Press, 1938.

the little schooled and the highly schooled populations; it hinders transition between their respective medieval and scientific languages and world-views. This conflict can be resolved to a considerable extent by appropriate translations and definitions of terms such as, for instance, the above definition of "religion." Discussion of this sort of translation is fruitful, for it can lead to mutual understanding and social harmony, to a sacred society. However, it can occur only when and where the idea of the essential differentness of science and religion is discarded.

And finally, as long as scientific theories are couched in logical categories denoting operationally inconstant unit phenomena, such as "science" as *contrasted* with "religion," unification of scientific theory itself is impossible. Only when these categories are redefined so as to correspond to operationally constant unit phenomena, such as the syndrome which I have defined as "religion," can scientific theory become unified, and science become religious even for scientists. If scientists themselves are hindered from unifying their world-view—if the salt hath lost its savor, to translate the notion into medieval terms—how can the people as a whole achieve it?

I cannot speak for others. But for me there are no such contrasting entities as science *and* religion. And there need be neither conflict nor harmony between them; for they can be one.

It is easier to correct the current meaning of the word "religion" when it is realized that this meaning is due to an historic accident rather than to efficient word-formulation.

In the early Middle Ages, Europe's world-view was nearly as integrated as the views of the Murngins and Aruntas. It did not include a totem-well theory, but it did include the notion of a stationary, square, flat earth, held up by

angels, with the heavenly bodies revolving around it. Step by step scientists suggested that the earth is spherical and rotates about the sun. In so doing they broke the unity and universality of the medieval world-view. Because of this they were regarded as heretical, as unreligious, which at that time they unquestionably were.

But, as the centuries passed, scientists suggested that the earth with its living things was not created in six days, as their contemporaries thought, but evolved more gradually; they produced the skeletons of beings which resemble apes more than their contemporaries had believed the earliest humans to have done. They suggested that blood circulates instead of standing still, as their contemporaries believed; that plagues are caused by the growth of bacterial populations rather than blows of Gabriel's sword, as they were popularly held to be. And so on, down the line. In a word, the scientists' view became ever more integrated and universal, and thus religious, while the medieval world-view became ever more disintegrated. It is through this historic accident that we have to-day been maneuvered into calling this medieval view "religious" when it has lost much of its religious force¹¹ and calling the scientific view "unreligious" when it is in many cases already deeply religious,¹² and is daily becoming more highly integrated.

To say, however, that unified science exists in the world of to-day, when the symptoms of mental *disorganization*—armed conflict, suicide, and insanity in their myriad forms¹³—are rampant, would be to contradict the notion that

¹¹ E. L. Thorndike, "Your City." New York: Harcourt, Brace and Company, 1939.

¹² Eve Curie, "Madame Curie." New York: Doubleday, Doran, 1937.

¹³ Karl A. Menninger, "Man Against Himself." New York: Harcourt, Brace and Company, 1938.

a unified world-view and moral, harmonious action constitute a unity. Instead of saying that science to-day is unified I would say that scientists are still divided into specialized discipline-groups, each with its own language, literature, and institutional administration; that each group of specialists—partly through necessity and partly through historic accident—is to-day ignorant of many crucial inter-relationships of the several scientific disciplines; that these groups duplicate each other's results in some places and leave gaps between them in other places; that each group is logocentric, over-emphasizing the part played in the universe by the phenomena it studies and under-emphasizing the part played by other phenomena; that consequently most of these people are scientists in their offices and laboratories, and non-scientists outside. Even *during* their working hours, as William James pointed out, most scientists are so concerned with isolated fragments of existence that one may well say that on the whole the influence of science goes against the notion that religion—a unified world-view—should be recognized at all.¹⁴ And this view has spread among the public until, to quote Robert Hutchins, "The most characteristic feature of the modern world is bewilderment. Any one who says he knows anything . . . [about the whole] is at once suspected of affectation or falsehood. We do not know where we are going or why . . ."¹⁵ That is to say, most people do not even realize that the world's present retrogression is in large measure the direct result of the non-integration of views and of actions, and that it can be halted and turned into progression *only* by the development of a world-view which is scientific, which is integrated and uni-

versal, which is vigorously expressed in action; which, in a word, is religious.

While science is not yet clearly unified, powerful unification movements are well under way. The physical sciences have undergone and are undergoing unification as a result of Einstein's theory; that is to say, as a result of the redefinition of logical categories in such ways that they become operationally constant. The technique of redefining terms is now being extended to the biological and social sciences, the methods for doing this being systematically developed by men working with what is called the general theory of signs.¹⁶ (As you can see, this technique is being applied, in this very article, to the terms "religion" and "science.") Symposia and round-table discussions are being held at the congresses of the American Association for the Advancement of Science by scientific organizations which did not meet together a few years ago. Their discourses are being published both in journals devoted to science as a whole and in journals which would formerly have barred them as alien subject-matter.¹⁷

¹⁶ Charles W. Morris, "Foundations of the Theory of Signs," *Encyclopedia of Unified Science*, Vol. I, No. 2. Chicago: University of Chicago Press, 1938.

¹⁷ To-day the Western Hemisphere's foremost scientific organization devoted specifically to the synthesis of scientific theory is the Congress for the Unification of Science and its *Journal of Unified Science* (formerly *Erkenntnis*), and the International Encyclopedia of Unified Science edited by some of its members. To the best of my knowledge, the University of Chicago is the first university to take organizational steps for the specific purpose of unifying scientific theory: the Interdivisional Committee on Unified Science, with Alfred E. Emerson (zoology) as chairman, Charles W. Morris (philosophy) and W. Lloyd Warner (anthropology) as members, to supervise and guide my efforts in this direction. The university has further facilitated these efforts with the grant of a special non-divisional fellowship. I should like to express my indebtedness for the help given me by this committee, and also by W. C. Allee and Robert Redfield in the formulation of this article.

¹⁴ William James, "The Varieties of Religious Experience." New York: Longmans, Green and Company, 1925.

¹⁵ Robert Maynard Hutchins, "The Issues in the Higher Learning," *International Journal of Ethics*, January, 1934.

The religious force of unified science is already manifesting itself visibly: the most fruitful methods for handling the terribly destructive force of the conflict between employers and employees have been discussed by my scientist neighbors here in Chicago, and their associates elsewhere.¹⁸ Such creation of harmony is a religious activity achieved through the practical application of a synthesis of the theories of many diverse scientific disciplines.

Integrated scientific studies have religious force because the social effect of any kind of action becomes apparent when—and only when—situations are viewed as wholes. Once effects are thus seen, they are inevitably *evaluated*. That is to say, processes are seen to be integrating or disintegrating; to be helpful or harmful to society; in a word, to be good or bad. Unified science is, like all religions, inescapably and directly connected with values, ethics and morals.¹⁹ And values are connected with action. The religious force of unified science (unlike that of most other world-views) is manifested in integrated knowledge, mutually comprehensible speech, and uncompromisingly social action.

As science becomes unified mankind

¹⁸ Fritz J. Roethlisberger and William J. Dickson, "Management and the Worker" (Cambridge: Harvard University Press, 1939); Elton Mayo, "The Human Problems of an Industrial Civilization." New York: Macmillan Company, 1933.

¹⁹ In the terms of the general theory of signs (footnote 16) unified science would be termed something like this: "An increased integration of pragmatic, semantic, and syntactic representations." In the terms of physiological theory: "Integration of the activity of the lower nerve centers with that of Pavlov's 'cortical analysers' and that of the speech and silent areas of the cortex." In the terms of Medieval Europe: "Closer communion of body, mind, and spirit." Such integration always and inevitably involves integration of man with his habitat. And this occurs in large part through scientifically directed action.

becomes powerful. Its power makes the world safer. The power of men gives rise to faith in the goodness of the universe and hope for the future of mankind. (This follows consistently because the world is "promising" and "good" to the degree to which we do make it, and expect to make it, meet our needs.) In short, unified science gives the power of knowledge, of faith, and of efficient action to the individual and to society. This power is the religious force of unified science.

There are men who to-day see science as their way of life; as the guide of their family intimacy, play and work; as the moulder of their private and public policy. These men, of whom I strive to be one, regard the development of unified science, and its linkage with its allied expressions, art and industry, as the development of the highest good: We view it as the growth of the quality which gives men dominance over inanimate nature, over the fate of other organisms, and over men's own destinies.

We view the individual and public policies which are conceived and carried out with humble and uncompromising realism, which are scientifically conceived and executed, as manifesting something of the divine. (And let every man define the term if or as he is willing and able to define it.)

III

Man-made organizations, such as machine factories, plant fields, and animal herds, do not consistently maintain a higher level of integration than the integration of the ideas they reify.²⁰ This was shown concretely during the early years of Soviet construction, when quantities of complex machines, bought

²⁰ Edward F. Haakell, "Ecological Formulas for Tools, Pictures, and Formulas," a paper prepared for the American Anthropological Association at its meeting in the American Association for the Advancement of Science, Philadelphia, December, 1940.

at great sacrifice, were ruined by non-complex peasants and workers who were striving desperately to preserve them. It is illustrated once more a few years later, now, when these people's ideas have become more highly integrated: unintentional deterioration has not only decreased, but machines are being repaired and produced in large quantities.

Our American super-organism was not planned by men but developed crescively. It just grew, like Topsy. Its rate of growth is the reverse of any mammal's rate of growth, and greater than the rate of earlier human societies: It took small-brained, thick-skulled Paleolithic men nearly a million years to develop percussion-flaked (Pre-Chellean) tools into pressure-flaked, hafted (Aurignacian) flint tools.²¹ It took us, larger brained mortals, only about 17,000 more years to develop the poorest steam-driven tools, and a mere 250 years more to develop tools (pursuit planes) that carry us up to 650 miles an hour. (And, according to the aeroplane designer, Igor Sikorsky, barring some catastrophic event, both the stratosphere liner, traveling at several thousand miles an hour, and the space rocket should be perfected within the next hundred years.²² These speeds are cited as "indicators" of a general condition:²³ the condition of a highly accelerated evolution of superorganismic structures and processes *in general*.

John Dewey has pointed out that there are anti-scientific forces in and outside our universities which actively oppose the unification of science (see

²¹ N. C. Nelson, "Prehistoric Archaeology," Chapter V in "General Anthropology," edited by Franz Boas. Boston: D. C. Heath and Company, 1938.

²² Igor Sikorsky, "The Story of the Winged-S." New York: Dodd Mead Company, 1938.

²³ J. E. Weaver and F. E. Clements, "Plant Ecology." New York: McGraw, Hill and Company, 1927.

footnote 10). In so far as these forces guide civilization it must and is breaking down with the full force of its acceleration until its structure reaches and, by its own momentum, passes below the degree of integration of their mental structure. The torpedoes, bombs, shells and gases being produced in the world's mines and factories,²⁴ the direct mass slaughter and the indirect slaughter through the epidemics and famines (present and soon to come)²⁵ seem to me to be in large measure the result of our maintaining today unintegrated views appropriate to earlier, less integrated social conditions; views, therefore, which produce actions highly disorganizing to modern society. In short, this slaughter is an effect of cultural lag and, unless actively guided by men with integrated minds, may convert lag into disastrous wholesale retrogression.

On the other hand, in so far as the men who achieve unified science guide civilization, it must build up until its structure approaches the degree of accuracy and integration of their mental structure. Growing techniques of industrial and scientific cooperation, consequent improvement of nutrition and health, general decrease of social and internal conflict and its symptoms, suicide and insanity, together constitute social integration. They constitute the progression which, as stated, should sooner or later result from generally creating and acting upon a unified scientific worldview. The struggle for such a view, it is true, is temporarily painful because it robs men of peace and force until integration is nearly achieved. But those who approach it closely enough to be assured that it can be achieved do feel and

²⁴ League of Nations, "Armaments Year Book," Geneva, 1933; Jane's "Fighting Ships," London: Sampson, Low, Marston and Company, 1939. Both these books understate actuality and are vastly out of date.

²⁵ "The Lord's Battalions" (listed in the table of contents as The Friends Service Committee). New York: *Fortune*, December 1940.

manifest its tremendous religious force. They feel that progress depends upon our *advance* to religion; to unified science.

From these considerations it seems to follow that to-day the crucial point of human advance is the necessarily cooperative activity of integrating the theory and practice of the several sciences, and teaching the resultant unified world-view to those personally concerned with organizing progress; which is almost everybody.

Concretely, this implies—as a start—the energetic execution of some such program as this:

I. Intensive study and development of the techniques necessary for the efficient handling of logical categories and their notation, such as the theory of signs and mathematical logic.²⁶ Institutionally organized, *integrated* polymathic courses of study (footnote 17) furnishing the data to which these techniques are to be applied.

²⁶ W. V. Quince, "Mathematical Logic." New York: W. W. Norton and Company, 1940.

AMERICAN CHARACTER

BUT there is one factor that may be more important than all others—the American character. There have even been doubts about this. One can estimate the tone and temper of a people somewhat from its songs. In the early days of this Republic its citizens sang "Hail Columbia," "Adams and Liberty," "Columbia the Gem of the Ocean" and the like. These were martial airs, but apart from their ring of defiance there were notes of pride and confidence in the destiny of this nation, of individual energy and of individual dedication—all applied to the achievements of peace as well as to those of war. A few years since, our popular songs were known as "blues." They were songs of distress and despair, songs of resignation and self-pity. And this was in a country that, to outward appearance at least, had already realized far more than the high prophetic hopes of a hundred and fifty years ago. No one questions that the peo-

ple of the United States are the best fed, the best clothed, the best housed people in the world. We are not arraigning American civilization on the frail criteria of songs; we are not arraigning it at all. But there is abundant evidence that something has happened to blur our vision of the benefits that American life has given and is giving to every one of us, the grateful and sacrificial loyalty that naturally follows and the duty that membership in such a nation entails upon each citizen to carry on its best for the good of all posterities to follow. A close examination will make clear that the trouble was far more with the vision than with the facts. There are fashions in thought as there are fashions in art. It became fashionable to take a "blue" view of America.—*Address of Dixon Ryan Fox, President of Union College, at the Inauguration Ceremonies of President Robert L. Johnson, Temple University.*

II. Development of our sporadic symposia into a permanent, interconnected organization led by an appropriate, trained polymathist.²⁷

III. Conscious, persistent integration of these organizations with popular churches, schools and clubs at strategic points.²⁸

This program proposes a conscious intensification of strategic processes already present in our democratic way of life. If carried out it should integrate the united nations as well as the minds and activities of their individual citizens. For, as our minds become increasingly integrated, our organizations will integrate themselves in like manner.

The goal of this process is a modern sacred society: Its method is scientific; its extension, universal; its direction, progressive; and its force, religious.

²⁷ An example of such an organization would be the Speciation Committee headed by Alfred E. Emerson. *Science*, 1940.

²⁸ The present article is a concrete demonstration of the feasibility of such a proposal: It was originally presented (in a briefer form) before a Quaker meeting—a unit of the Religious Society of Friends—of which I am a member.

THE AGE OF HOMO SAPIENS

By Dr. W. W. HOWELLS

DEPARTMENT OF SOCIOLOGY AND ANTHROPOLOGY, UNIVERSITY OF WISCONSIN

It is customary to speak of the time since the beginning of the Ice Age, or the last million years, as the Age of Man, because its geological deposits are embellished with the stony fruits of human handiwork as well as with the fossilized fragments of man's own frame. But this is otherwise a loose term. What kind of a "man" is meant?

As an erect animal newly distinct from an ape, with a growing propensity to reinforce his hands with rocks and sticks, man is probably older than this, by far. De Terra, it is true, believes that the advent of the ice itself, shifting climatic zones southward in Asia and causing a dispersal of the once flourishing ape family into new and varying environments, was the indirect stimulus to the emergence of man from the anthropoids, so that this event, he thinks, must have happened within the Pleistocene period itself. But many students, Hooton being the most articulate, feel that man must have been evolving for several million years at the end of the preceding Tertiary era, using tools of stone which can not even be recognized to-day, before getting to the stage of physique and culture which we see in the earliest known remains. Man's age, in other words, is doubtless several times as great as the "Age of Man."

On the other hand, we ourselves, in our present form, constitute one particular and definite species of man, the species *Homo sapiens*, which must have arisen later on within this total limit of time. He is an advanced type and is distinct from various other known human¹ forms. However, almost all

¹ "Human" in the anthropological sense refers to the whole hominid family, and not to our own species alone.

these forms seem to be well above, and therefore later than, the earliest imaginable stage of true humanity, and all may be thought of as lines, gradually separating, which descended from the original human stem. *Homo sapiens* appeared somewhere as such a line but how old he is, as a species, we do not know. Curiosity as to his age is not simply the mark of a fond antiquarianism, for information on the pace of recent human development would give us a better perspective for the possibilities of future change in mankind. How old, then, is *Homo sapiens*?

We really can not say, taking the remains alone. If we dutifully repeat only what paleontology has revealed so far, it would seem as though *Homo sapiens* were very recent. (Actually, we know somewhat more about the age of our nearest neighbor in time, the species of Neanderthal Man.) There is, however, some imperfect evidence that indicates *Homo sapiens* as being fairly ancient, and there are various abstract considerations and deductions which bear this belief out.

Put purely in terms of skeletal evidence, this is what we know. 1. There is archeological proof of human existence apparently throughout the Pleistocene, running back a million years, to use a figure, or 1,000 millenniums. 2. There are remains of the species *Homo sapiens*, and *Homo sapiens* only, going back some 30 millenniums (more or less, actual dates not being certain) to the Cro Magnons, who appeared at the beginning of the Upper Paleolithic, the last portion of the Old Stone Age. 3. In the previous 950 or more millenniums (the disproportionately long Lower Paleolithic, comprising 19/20 of the whole Pleistocene)

there were various types of fossil men, but no finds have been made which would prove, with the finality of a theorem in geometry, the presence of *Homo sapiens*. Thus there is a break, at the beginning of the Upper Paleolithic, with no indisputable men of our own species earlier, and no men of any other species after it. The situation is such that only the captious would deny that *Homo sapiens* existed before the Cro Magnons, who are his first clear manifestation; but on the other hand it is not such that any anthropologist can wring general agreement from his colleagues as to a particular time, whether relatively late or going back toward the beginning of the Ice Age, when *Homo sapiens* might be said first to have become a distinct species.

Through the long reaches of the Lower Paleolithic there is sprinkled a corporal's guard of human fossils. The Neanderthal species is well represented by finds, especially in the west, which can be referred to the last 100 millenniums or more of this time. Equally well known (for the cranium at least), thanks to recent discoveries, are the Java and Pekin types, obviously related to one another and probably dating from the lower middle part of the Pleistocene. Aside from these, the main species are largely single specimens or scraps: the Heidelberg (an early forerunner of the Neanderthals) and Piltdown men, and the undatable Africans—the Broken Hill skull of Rhodesia, and Africanthropus, from the Lake region. Of all these and certain others none is assigned to *Homo sapiens*. This gives a picture of several species of man, some of whom at least must have been contemporaneous, though differing considerably. The question is: Did *Homo sapiens* also overlap any of them in time, or did he, appearing late, arise from one of them, and if so, from which one?

The possible representatives of our own species during the Lower Paleolithic are

not many. (There are reasons, however, for not expecting them to be. For example, *Homo sapiens* has a thin skull, which is less likely to survive in fossil form.) One is the Galley Hill skeleton of the Thames valley, whose physical type is fully *sapiens* but whose geological claims to antiquity are impaired by the confusion and carelessness which attended its discovery in 1888. There are a few other modern-looking skulls with similarly sullied credentials. Otherwise the skeletal evidence of early *Homo sapiens* rests on two finds. The first is the very important Swanscombe skull, also of the Thames valley, whose parts were found in an absolutely certain connection (a rare thing) with glacial deposits and archeological tools which are believed to belong to the second interglacial, in the first half of the Pleistocene. It is thus very ancient, but its establishment as an actual specimen of *Homo sapiens* has to rest on the crown and back of the head, all else being gone. This is not entirely satisfactory. Most are inclined to accept its validity, and to believe that it legitimizes Galley Hill at last, but some would regard it with acute suspicion, remembering that the back of the ape-jawed Piltdown skull would seem almost equally modern. The other main find comprises skeletons from two caves at Mount Carmel in Palestine, excavated ten years ago and dating apparently from the later part of the Lower Paleolithic. In the Tabun cave was found a Neanderthal-like woman with some *sapiens* characteristics, while the Skhul cave contained several skeletons of a practically *sapiens* type but with Neanderthal-like features. The interpretation of all this is likewise in doubt. The discoverers believe that they have found what is perhaps the actual moment of appearance of *Homo sapiens*, while others think the skeletons represent a mixture of the two species, in which case *Homo sapiens*

must already have been in existence, and probably for some time.

This is not much with which to reconstruct the trail of *Homo sapiens* into the past after the visible part of it disappears abruptly with the Cro Magnons, or at best becomes pocketed in the mysterious case of the Mount Carmel skeletons. Even if we provisionally accept the Swanscombe skull as a specimen of *Homo sapiens*, there remains a large gap in time between it and the Cro Magnons, bridged only by a moral certainty. Consequently there is a flourishing diversity of opinion in the whole matter—notice that even regarding the Mount Carmel skeletons alone there are currently two quite different explanations, logically leading to equally different conclusions as to the age of our species. In general there are two schools of thought. One holds that the development of *Homo sapiens* was independent of that of other species, all of them being considered as a constellation of different descendants of a common source placed well back in Tertiary time. At the other extreme are those who would graft him onto some one of the known non-*sapiens* forms of man, at some period well along in the Pleistocene.

Neanderthal Man supplies a case in point. Becoming extinct less than 50 millenniums ago, he seems to have ruled Europe for the preceding 100 millenniums at least. A few students think that during his career he gave rise to, or influenced, *Homo sapiens*. Others feel that this is not so; that his physical unlikeness, in his low, massive head and huge face, is too great, and that he had developed definite peculiarities of his own which are not to be found in modern man and which would therefore exclude him from our ancestry. In spite of all the racial variety of the latter, and a considerable variety in the Neanderthal species as well, there is no actual overlapping of the two stocks in physical form.

Now if there has not been any important connection between the two species in recent times, then it would appear that *Homo sapiens* existed somewhere outside of Europe, and that his line goes back, parallel to but not connected with that of the Neanderthals, for many thousand years. Does it go back to the Java and Pekin types, or is the same situation repeated here? Probably it is. The Swanscombe skull shows, if it shows nothing else, that a high, vaulted brain case of the *sapiens* type, whether actually parental to that of our species or not, had been evolved in the human family long before the known period of the Neanderthals, and almost certainly as early as, or earlier than, the backward Java-Pekin family. And the always-mysterious Piltdown skull, in spite of its extremely ape-like jaw, has a very human brain case which indicates the same thing.

It is possible to disregard the limitations of the fossil evidence and to take a fresh view of the problem by considering the living races of *Homo sapiens* as they now stand, and as they have probably been in the past. To-day two billion people are spread thickly upon the earth. They are divided somewhat unequally into the conventional White, Yellow and Black, with infinitely weaker representations of American Indians, Australian blackfellows, South African Bushmen, and so on. They constitute different races but all belong, from a zoological standpoint, to a single species. None of these races alone is the type of the species, which is made up of all of them together. In other words the most advanced is not necessarily the most typical. It would indeed be more proper to represent *Homo sapiens* as a whole by his most primitive manifestation, the native Australian, or by an imaginary form of this sort, which could have become the parent of all living races, as a sort of greatest common denominator.

The picture of the present suffers from

lack of depth, because our collections of skulls of various ethnic origins do not go back far enough to tell much of history on a grand scale, and the older remains give us only the barest of indications as to race. Nevertheless, it is clear that before we even begin to trace races back we must modify this picture because of violent changes which must have taken place in the very recent past, in the time since culture really began to develop.

A mere ten thousand years ago, toward the end of the Paleolithic, man knew only the art of hunting. Since then, with the onset of the Neolithic, he has progressed to agriculture, opening a vast food supply to himself; later on, in the Bronze Age and classical times, he has benefited by town life and artisanship, and still later, in the last few centuries, by the subjugation of natural forces to the purposes to transportation and manufacture. These things have occasioned an almost incredible increase in the population of the world. Throughout his previous existence, man could never rise in numbers above what the stable animal population in any region would feed. It can be estimated, from the little that is known about the recent rate of increase, and the population density of present-day hunting peoples, that there can have been only something like ten million beings in the then inhabited world, compared to the two billion of to-day. (For example, the New World, most of whose people were relatively advanced in culture, had a population of roughly eight million at the time of discovery.) Now in this tumultuous upsurge of some two hundred fold, it is plain that those peoples who participated in the progress of culture would increase and monopolize the world, while those who remained hunters would continue to be few in numbers and sparse in distribution, or would even face extinction on encounter with a people more advanced.

Ten millenniums is a very short time, being only one hundredth of the "Age of Man," yet it has produced this revolution, this amazing upheaval in numbers and in attainments, which is in vivid contrast with the long previous span of man's existence during which culture had plodded ahead at a barely perceptible pace. Very few Bushmen remain in South Africa, or blackfellows in Australia, and these have probably survived by grace of living in a desert and a remote island respectively; but in those days of the end of the Paleolithic the races we distinguish to-day must have been more equal in numbers. The point of this effort to ignore the present scene, and instead to restore that of 10 millenniums ago, is to give these now negligible races their proper significance. When they and possible others stood on more equal terms with those which dominate to-day, the whole species would have presented an appearance of even greater diversity than at present, and this very diversity is an index of the age of the species itself, because races can not have appeared overnight.

Races seem to have formed almost entirely as the result of random evolution. It is conceivable that the tropical sun was an influence in establishing dark skin in the possessors of that feature, and woolly hair as well. If so, it was certainly a long process, too gradual a one to have affected the Indians of tropical America over many thousand years. But geographic isolation, the simple separation of groups descended from the original *Homo sapiens*, was probably the most important factor. Such groups changed slightly but continuously, by nature's laws, and being separated geographically, they tended to drift aimlessly apart in physical form as well, becoming racially diverse. Bagehot, the economist, once suggested that when man was new his meager culture allowed

natural selection to act powerfully upon him, leading to the rapid development of races. This is a poor hypothesis all around; natural selection would affect the functional development of his legs, etc., but selection would actually tend to prevent racial differentiation. There is no real reason to think that there was irregularity in the speed of racial development, or anything except an even increase in diversification, which reached a maximum about ten thousand years ago.

The process probably took a long time. The only sighting point by which we can judge its pace is the beginning of the Upper Paleolithic. The first unquestioned *Homo sapiens*, the Cro Magnons, demonstrate: (1) that there has been no progressive racial development, as far as can be seen, in some 30 millenniums, and (2) that the men of that time were hardly more primitive in an evolutionary sense. In Europe, the Cro Magnons and related types were purely "white" in character, showing that this racial stock, at least, was fully developed and by no means in any embryonic stage. And there is some evidence from other skeletons of comparable age that the Negro and Mongoloid stocks were equally well established. Furthermore, the native Australian of to-day is infinitely more backward in form than were these ancient

Caucasians; indeed the fact that the most primitive branch of the species that we know of should be found in a living race rather than an ancient fossil emphasizes again our ignorance of early stages of *Homo sapiens* development.

Now, if no material change in the degree of racial differentiation can be observed in the time from the present back to that which immediately follows the disappearance of the Neanderthals, then it can hardly be denied that the development of all the races out of a common stem must have taken a period several times as long as this one. Even the time when the now archaic Australian, chinless and small-skulled, and with beetling brows and protruding face, represented the forefront of *sapiens* development must be relatively remote. (Galley Hill and the other geological hoboes were more advanced than he.) So from this consideration alone, it would appear that *Homo sapiens* must go back as a distinct species to the middle of the Pleistocene at least, and probably much further. This being so, it is difficult to believe that the Swanscombe skull can have belonged to some other species. And certainly if for these additional reasons the Galley Hill man, who has about the same putative date, can finally be accepted, then the age of *Homo sapiens* must be really great indeed.

ON THE VALUES IN CULTURE

By Dr. MELVILLE J. HERSKOVITS

PROFESSOR OF ANTHROPOLOGY, NORTHWESTERN UNIVERSITY

MANY reasons have been advanced to account for the wide-spread critical discussion of our political and social system during the past year or two, especially the search for ultimate values and understandable goals by which to order our lives. That the war has had an unsettling effect on our thinking is self-evident; and this is the reason most often brought forward by those who attempt to account for the phenomenon. Yet in itself the war is not enough, for two decades ago a war of equal magnitude failed to produce either the kind of questions or the intensity of questioning of institutions and ways of life which confront us on all sides to-day. Mr. Archibald MacLeish has suggested¹ that blame must be laid on the scholars and writers for the current uncertainties reflected in scepticism as to the ends of democracy and the meaning of "an American way of life," and questions raised concerning the kind of world order that is to be sought and the sort of social and economic system that can best function so as most effectively to further human happiness. That blame may not go unrecognized, though to lay it is also not enough; for the confusion of issues and aims is too widespread to refer to such *ad hoc* explanations. We must be alive to the deeper currents, which, unheeded these many years, have affected the movement of thought in our society in the same way as we can see such currents to have influenced other societies than our own, or to have been significant in earlier periods of our own history. To emphasize that such deep currents do most of their work

before they bubble to the surface is merely to underscore the importance of understanding their nature and significance when they appear in our lives.

An analogy to be drawn between our present situation and the experience of many primitive peoples during the initial phases of their contact with European colonial expansion may be helpful in aiding us to comprehend the urgency of our present quest for values. The explanation of the reaction to conquest of such folk is sometimes phrased by the native peoples themselves in terms of the superior strength of foreign gods; sometimes in terms more familiar to our own way of thought. This latter point of view, for example, is expressed by a proverb of the West African Dahomeans, which says: "War never goes against the Whites, for they have the cartridges." Whatever the native reason, it is not difficult to understand why primitive peoples so often become demoralized at the onset of an assault by an aggressive, differing ideology that does not neglect to make the most of the sanctions that derive from the greater effectiveness of their armaments. And it is just this situation that is to-day faced by those who, in our society, are witnessing the underlying values of their own political and social system assailed by an opposing ideology which validates the way of life based on it by a vaunted superiority of power.

Our analogy holds further, and in some detail. We may consider, for example, the techniques of aggression that have been employed by European governments during the years their empires were building. In some parts of the world, of course, it was merely a matter

¹ "The Irresponsibles," *The Nation*, May 18, 1940, and "Post-war Writers and Pre-war Readers," *The New Republic*, June 10, 1940.

of establishing an administration to rule unresisting tribes. In a far greater number of cases, however, control over a reluctant people was preceded by an infiltration of European nationals—missionaries and traders, in the main—who, having settled in the far parts of the earth, became, perhaps unwittingly, the instruments of expansion. Sooner or later, certain prerogatives claimed by these persons came to be resented by the natives; protest eventuated in mistreatment or death of the Europeans; a punitive expeditionary force was dispatched; and the members of what had been an independent, local group found themselves members of a world empire. A third technique was of a similar efficacy; in these cases a group who were the rivals of those in power were encouraged to appeal to a ruler across the far waters for aid in establishing a régime of their own. In most instances, a protectorate followed on aid given, with eventual absorption as a colonial possession.

It is obvious that these are precisely the methods that have been employed in recent years by the totalitarian governments. The case of Ethiopia is a marginal one as concerns attitudes toward these events, since here it was a question of African expansion. But when in Albania, Czechoslovakia and Poland the method of rescuing an oppressed minority—the equivalent of the traders and missionaries among primitive peoples—was employed to implement territorial aggrandizement; or, as in Spain and Rumania, a faction other than that in power was aided in establishing itself as a prelude to physical or ideological infiltration, it began to be realized that what was possible in the remote corners of the world was also possible near to home. And those who in Europe experienced the overthrow of their countries and the accompanying attack on their traditions, or those who looked on at these events from afar, unable to stem

the hostile drive, experienced the same sense of frustration that primitive folk experienced as they were absorbed into the empires of Europe and America.

As far as our own society is concerned, this kind of reaction is discernible in most of the questions that, though to-day asked more often and with greater insistence than in earlier years, have been increasingly raised ever since the onset of fascism eighteen years ago. In essence, they are to be subsumed in the question, "Can democracy work?"—a question that has appeared with ever greater frequency as the totalitarian governments, pressing their ideological warfare, have come to be recognized as less and less amenable to the international procedures that had rooted more deeply in our thinking than we had realized. It must also be remembered that an increasingly important precept in our belief has concerned efficiency in the industrial field. Yet in organization for war, and what seems to be organization for survival itself, nations which are openly hostile to our manner of life have manifested a degree of efficiency that has seemed impossible to achieve by those whose values are under attack.

Let us turn again for a moment to those underlying currents of thought, already referred to, whose power has gone unrealized but which have, nonetheless, always been potent in the historic stream of our culture. One of the proudest achievements of our civilization is the development of the scientific approach to the problems of life. Yet the essence of a philosophy based on the scientific method is constant questioning, continuous analysis, never-ending scepticism. Students of human civilization have with others given themselves to this stream of thought, and since the turn of the century all cultural values have been subject to constant investigation. This is in sharp contrast to what obtained before the turn of the century, when our

culture had achieved a condition of stability that was only beginning to be disturbed. At that time, there were few doubts in the minds of scholars, and less among others, to disturb the conviction that our own way of life was superior to all others. Varying civilizations were coming to be known, but knowledge of them was principally useful as documentation of the hypothesis of an evolutionary development of culture, in terms of which the traditions of Euro-American societies were held to be the flowering of human experience in much the same way as man himself was held to represent the ultimate product of biological evolution.

As time went on, however, and more and more knowledge of other civilizations became available, this complacency began to be challenged. The defects in our own way of life were coming in for ever wider recognition; the adjustments made by individuals and groups constituting other societies came increasingly to be stressed. The theory of cultural evolution was the chief object of criticism, and with it the point of view that human civilizations could be evaluated on a scale of better and worse. By the end of the last war, reaction to this had reached its peak in the denial of the existence of all laws of social development. This position, and the related stress on the impossibility of evaluating cultures at all, received what was perhaps their ultimate expression in the following passage:

If inherent necessity urges all societies along a fixed path, metaphysicians may still dispute whether the underlying force be divine or diabolic, but there can at least be no doubt as to which community is retarded and which accelerated in its movement toward the appointed goal. But no such necessity or design appears from the study of culture history. Cultures develop mainly through the borrowing due to chance contact. Our own civilization is even more largely than the rest a complex of borrowed traits. The singular order of events by which it has come into being provides no schedule for the itinerary of alien cultures. Hence the speci-

ous plea that a given people must pass through such and such a stage in *our* history before attaining this or that destination can no longer be sustained. . . . In prescribing for other peoples a social programme we must always act on subjective grounds; but at least we can act unfettered by the pusillanimous fear of transgressing a mock-law of social evolution. Nor are the facts of culture history without bearing on the adjustment of our own future. To that planless hodge-podge, that thing of shreds and patches called civilization, its historian can no longer yield superstitious reverence. He will realize better than others the obstacles to infusing design into the amorphous product; but in thought at least he will not grovel before it in fatalistic acquiescence but dream of a rational scheme to supplant the chaotic jumble.²

The recognition of the impossibility of evaluating different cultures is to-day firmly established, and represents a great advance toward clarity of thought as concerns the nature and functioning of human civilization. Yet it would nonetheless seem that the pendulum, in swinging toward the position that it is impossible to evaluate differing cultures, has overshot its mark, since it has caused us to overlook how important are the values of a given culture to the people who live under it. Our civilization may indeed be recognized as in no way inherently superior to another when the two are compared in terms of what each means to its carriers; but this does not signify that every body of tradition is not regarded by those who live according to it as embodying the best way of life for them. And this is why the imposition of a foreign body of custom, backed by power, is so distressing an experience. A people may recognize never so clearly that their own customs are best for them, yet no matter how deep their conviction of this, it is supremely difficult for them to meet the immediate argument posed by the possession of superior force.

Folk thus challenged are, moreover, caught between two conflicting points of view after their secondary adjustment to

² E. H. Lowie, "Primitive Society," pp. 440-441.

conquest has been achieved. They may recognize certain benefits from the situation in which they are subject to a foreign ruler, yet it continuously rankles that the direction of their own affairs has been taken away from them. They may recognize certain values in the ideology being pressed on them, or to which they are otherwise exposed, and yet can not but feel that for them their own way of life must be best. An example may be given from West Africa, as an instance of a point of view that could also be cited from many other parts of the primitive world. To the objective observer—at least, to the objective observer from our society—there can be little doubt that the imposed rule of the French and British empires has brought many material benefits. Slavery has been put down, and human sacrifice, and warfare; and it is thus possible for a man to live and trade where he will without fear of losing his personal liberty or his life. The introduction of European medicine has gone far to reduce the many deaths in childbirth, infant mortality and such pernicious and wide-spread diseases as sleeping-sickness, leprosy, and the like, which prevailed in earlier days. Granting the economic exploitation of the natives, it is at the present time neither as direct, as brutal nor as extensive as was that of the displaced native dynasties. Yet despite all this, the native African speaks longingly of older times. He will grant that much has been brought him by the European; yet he will nevertheless, when speaking frankly to one not connected with government, missions or trading companies, express a nostalgia for the days when European control was not present, if he is an old man; or, if he is young, look forward to experiencing freedom from that control. There is, indeed, some reason to feel that the concept

of freedom should be realistically redefined as the right to be exploited in terms of the patterns of one's own culture.

It would seem that a change of direction in our thinking is called for. Those who are seeking to understand the nature of human civilization and its effect on the men and women who live under it must separate the evaluation of different cultures from the problem of value in culture. Granting that our own body of tradition is but one of many such bodies—just as we to-day recognize that man is but one unit of the biological series—it must not be forgotten that our society has developed values whose importance for us must be recognized and sustained if we are not to be bested in the ideological struggle that goes on about us, whether or not physical conflict accompanies it. Such analyses of fundamental values in our life as that contained in the recent discussion by Professor Carl Becker³ indicate the kind of realization our society must come to, and quickly. It must be made clear that this does not imply that the constant questioning which is the essence of the scientific approach need be given over, or that we must abandon the constant search for better methods of social and economic adjustment, or the struggle against the inequalities and injustices that mark our social order. But in terms of the present world situation, we must clearly understand that it is possible to reaffirm in positive terms the fundamental tenets by which we live, even while we recognize the shortcomings in the organization and functioning of our society. On the ideological front, such a realization is essential if the values and goals by which we order our lives are to be maintained in the face of the present assault on them.

³ "Some Generalities that Still Glitter," *Yale Review*, Vol. XXIX, No. 4, summer, 1940.

THE BACKGROUND OF MODERN VEGETABLE CONSUMPTION

By WILLIAM KLING

BUREAU OF AGRICULTURAL ECONOMICS, UNITED STATES DEPARTMENT OF AGRICULTURE

SOME vegetables have been used as food since ancient civilized days. However, compared to modern diets, the diets of the mass of people in most parts of the civilized world formerly contained more cereals and fewer vegetables, fruits and meats. One need go back only a few centuries in Europe to find cereal foods the most important part of the diet. Bread was the staff of life. Meats and their products were consumed in quantity only by the wealthy, although fish were eaten in large numbers around coastal areas.

Consumption of vegetables, such as onions, cucumbers, cabbages, leeks, beets, radishes, turnips, cauliflower, lettuce, watercress, asparagus, parsnips, some types of beans, green peas and eggplant, may be traced to early Egypt, China, India and Asia Minor.¹ The Egyptians, Hebrews and Greeks in their literature note the use of cucumbers and peas, and the use of cabbage is about as ancient as history itself. We know in particular that the Romans had under cultivation a wide variety of truck crops,² although consumption of these crops was probably quite limited.

During the Medieval Period in Europe few vegetables were consumed. The ordinary man sought his food primarily in bread and other cereal foods. Some fish, meat and meat products were consumed by him when available. In season he used a few common vegetables such as onions, turnips and cabbage.

¹ The Bible and other ancient works mention many vegetables. See Yearbook of Agriculture 1925, p. 8137 and 1937, pp. 171-574.

² Numerous vegetables were listed in the "Edict of Diocletian."

But it is probable that vegetables played only a very minor part in his diet. Consumption was limited to the few crops that were known and to the local seasons and areas of production because transportation and storage were inadequate. Further, the value of vegetables in the diet was not realized, and for some time the general belief existed in England that they were harmful. The rich ate a wide variety of food, including meats, wine, fruits, dairy products and spices, but vegetables were conspicuous by their absence. The English peasants consumed "black bread, milk, cheese, eggs and occasionally bacon or a fowl,"³ and fish. The quality of food was extremely low. Vegetable consumption was at a minimum.

But as early as the fourteenth century signs of increasing consumption appeared in Italy, Flanders and France. With the breakdown of the feudal economy in these countries cities grew, transportation developed and knowledge spread.

New varieties of vegetables were introduced from distant lands. Although consumption lagged in certain parts of Europe, by the end of the seventeenth century in many areas a variety of vegetables were consumed in moderate quantities. Demand increased particularly for commercial vegetables because of the shift of large sections of the population to commercial and industrial pursuits which discouraged home farming. Many vegetables were soon shipped into the cities from nearby market gardens.

³ J. C. Drummond and Anne Wilbraham, "The Englishman's Food," 1939, p. 51.

The New World made its contribution at this time by introducing maize, "Irish" potatoes, sweet potatoes, tomatoes, some beans, pumpkins, squashes and green peppers. The "Irish" potato was the most important of these crops. It soon had a welcome reception awaiting it in the poorer countries of Europe, such as Ireland, where it was introduced about 1650. By contrast, in its native America and in England it did not achieve popularity for another century. Most other American truck crops were neglected for some time; the tomato was not cultivated except as a novelty until about 1830, although it earlier achieved some use in Italy.

As the commercial and educational revolution reached its full bloom, cultivation and consumption of truck crops became more widespread. By the eighteenth century the many towns and cities that were developing on most parts of the Continent were supplied with vegetables by nearby market gardens. After a lag of some years widespread cultivation developed in England also. Those who could afford to buy vegetables now found celery, cauliflower, potatoes and savoys to supplement the few established and available vegetables, such as cabbage and onions that had long been in use.

But consumption of these foods, which were, in many cases, luxuries, was confined mostly to the rich. In England, the poor were more undernourished at this time than in medieval days. The industrial revolution, the factory system and the enclosures had crowded them into slums. Wages were sufficient in many cases only to buy bread and potatoes. Very little meat and few vegetables were eaten by the majority of the people. By contrast, in manorial days, the peasant had had some subsistence from his land and his lord. Vegetable consumption had increased

for the growing middle class and the wealthy but only slightly for the poor.

It should be noted that consumption of vegetables was still limited by other factors besides the inability of the common man to pay for them. Vegetables could be secured only in summer months because of inadequate transportation and storage. Their value as a food was still not fully appreciated. Many crops were unknown.

Yet with the passage of the reform laws during the nineteenth century, the condition of the poor began to improve and the consumption of vegetables increased. The technological and scientific advances of the twentieth century, coupled with the increased purchasing power of the people, caused vegetable consumption to rise to higher and higher levels. But many sections of the population still remained woefully undernourished.

II

AMERICAN DEVELOPMENT

The early American settlers learned cultivation of many new crops from the Indians. The colonists were forced to subsist to a large extent on these new food crops for lack of other sustenance, but also grew to recognize their value. As noted, by the seventeenth century, many American vegetables had found their way to Europe and were soon prime crops in some countries. The "Irish" potato derives its name from its wide use in Ireland even before it was considered important in its native America. On the other hand, many Old World vegetables soon found important places in American agriculture.

In Colonial America, crops were generally cultivated for local or home consumption, although some cereal crops were exported. Most farmers had their own fields of wheat, barley, oats and rye, and their own pig pens and vegetable patches. Households were largely

self-sufficient and obtained only a small fraction of supplies like salt and flour from outside the home and then mostly from local producers. Practically all vegetable supplies were secured from the home garden.⁴ In these gardens a variety of vegetables were grown, such as lettuce, beans, cabbage and potatoes; the more hardy were stored. There was little commercial production and what there was took place on a local basis. Consumption was largely limited to the local season of production and only to those vegetables which could be grown locally.

During the nineteenth century, the development of urban communities and rail transportation in America caused a great increase in the commercial production and availability of many agricultural products.⁵ The increasing tempo of the industrial revolution and its corollary, the urbanization of population, brought many changes in the method of obtaining food supplies and in the type of food eaten. Immigrants came to this country by the million. The nation began to do its work in factories. Most workers did not have the time or the land to grow their own food and they became dependent on others for supplies. Specialization marked the trend. Part-time farming and gardening was practiced by some who had their homes on relatively cheap and spacious land, but those who settled in the large densely populated cities looked to others for their food. By the middle of the nineteenth century, large cities that specialized in industrial occupations were tak-

⁴ It must be noted that even in home and farm gardens the variety of vegetables was limited and supplies could only be secured in season. Tomatoes, one of the most valuable vegetables to-day, were not widely used until about 1830 and could be secured only in about two or three months of the year. Many common vegetables and vegetable uses of to-day have been introduced only in the last twenty-five years.

⁵ Richard O. Cummings, "The American and His Food," 1940, Chapter V.

ing great quantities of food from surplus-producing agricultural areas.

Although the division of labor within the new specialized economy created a need for commercial food production, the commercial production of vegetables lagged. This lag was due in part to the ease with which a large part of the population could grow its own vegetable supplies in season. Also, although vegetable shipments from relatively nearby areas were possible, technical facilities were still inadequate for storage or for shipment of perishables from distant areas. Neither did food habits, dietary knowledge and modes of life create a great demand for vegetables. Further, a relatively low standard of living did not allow for mass consumption.

But the discovery of canning in France altered this situation somewhat. Nicolas Appert published his treatise on canning in 1811 titled, "The Book for All Households on the Art of Preserving Animal and Vegetable Substances for Many Years."⁶ Foods could now be preserved for off-season use and for use far from the areas of production. By 1820, crude and canned goods were produced commercially on a small scale in the United States. The Civil War gave impetus to canning in efforts to supply the armies with food. But a method of supplying foods out of season and far from the areas of production was bound to expand without the war stimulus. By the end of the nineteenth century, canned vegetables, particularly tomatoes and corn, were widely consumed. Commercial areas of canning production, in places far from the consuming market, developed, and the localization of truck-crop production was modified. Vegetable consumption increased.

By the end of the nineteenth century, the same technological revolution that

⁶ "Le Livre de tous les Menages ou l'Art de Conserver pendant Plusieurs Années Toutes les Substances Animales et Vegetables."

had developed canning resulted first in the discovery of the railroad and then in the perfection of a refrigerated freight car. This made the distant shipment of perishables possible and therefore widened supply areas.⁷ First used to ship meats, it was a relatively short time before refrigerated freight cars were used to ship fresh vegetables from distant areas. High prices could be obtained by shipping vegetables to large markets in seasons when local supplies were not available; growers located far from consuming centers increased production. High prices offset high freight costs. Large corporate vegetable farms developed to compete with the traditional family unit. Another impetus was given to consumption.

And with the development of research on nutrition, the value of vegetables in the diet became common knowledge. In addition, the increase in purchasing power made other than subsistence foods available. New uses for old vegetables were found and other vegetables were drawn out of relative oblivion. The population worked less strenuously. Machine power replaced hand power and people required fewer calories. "Lighter foods" like vegetables were consumed in greater quantities. At the same time the urbanization of population continued while population itself increased. The consumption of commercial vegetables showed marked growth. Rail shipments of vegetables increased steadily from no

⁷ See Wells A. Sherman, "Merchandizing Fruits and Vegetables," 1928, pp. 3-45.

shipments at all to the hundreds of thousands of carloads shipped to-day. Recently the motortruck has added greatly to the means of supplying vegetables.

To-day, although many consumers are ill fed, most markets are amply supplied with sufficient vegetables in all seasons. Produce arrives by rail, boat, truck and wagon. In certain cases, market controls have been instituted to modify the gluts of winter-producing, as well as summer-producing areas. The major part of the nation lives in urban communities and looks to commercial producers for vegetable supplies. Farming is largely specialized, thus creating a demand for crops other than those specialized in. Food habits and lower prices favor vegetable consumption, as well as a host of new uses such as quick-frozen vegetables and vegetable juices.

Apparent per capita consumption of fresh vegetables, excluding potatoes and sweetpotatoes, increased from an average of 133 pounds in 1920-24 to 164 pounds in 1935-39. Apparent per capita consumption of canned vegetables showed an even greater rise. From an average of 14 pounds consumed in the crop years of 1919-23, consumption increased 54 per cent. to 22 pounds in 1934-38. Although consumption figures are not available for earlier days, it is safe to say that vegetable consumption has had a continued upward trend through the years. If the advice of nutritionists is followed, this trend should continue to much higher levels.

THE SPECIMEN FETISH

By W. L. McATEE

WILDLIFE SERVICE, U. S. DEPARTMENT OF THE INTERIOR

THE statement, "At least one specimen of every form listed has been examined by some qualified ornithologist," is typical of modern formal lists of birds. While recognizing that specimens must be collected to gain particular definite bits of information or to settle certain questions of identity, the writer would point out that specimens are not necessarily infallible vouchers of occurrence and that in the last analysis the main consideration is the integrity and exactitude of the collector or observer.

The utility of a specimen to the compiler of a list depends upon the label. A label may be attached to a wrong specimen in early stages of its preparation, or may be misplaced later. Aside from such hazards, labels may be deliberately switched, their legends may be untruthful or they may be wholly faked. Let any one who does not believe that such things occur glance through files of the minor ornithological magazines of the 80's and 90's.

Labels, in fact, have no absolute, but only a qualified value. And what is it that qualifies their reliability but the integrity of their writers? The thing that finally must be accepted or rejected is some individual's word, and the largest factor in the decision will be what is known of that person's dependability.

Waiving questions of subspecies, statements about the distribution of which are 90 per cent. or more rationalized anyway,¹ the recording of species of

¹ That is, subspecific designations in bulk are copied from "authorities" and do not rest on specimens. Even the specimen identifications, as a whole, have to a large extent involved material other than breeders from the breeding ground, and thus not wholly valid for subspecific determination. That part of the science is intricate and can well be left to advanced systematists. Local lists would be a great deal more dependable than most of them have been if they ignored geographical races.

birds need not always be based on specimens, granted there are enough honest ornithologists. Would such a scientist's word need backing that he had seen an American egret, a marsh hawk, an English sparrow or a starling? or for that matter any of a majority of our birds? Must a scissor-tailed flycatcher or a magpie, unmistakable species, be collected to prove that they occurred somewhere far away from their normal ranges? If the observer's word without a specimen is to be rejected, how does it so increase in value as to be accepted by being written on a label? The whole question of the credibility of records is merely the integrity of the observer.

One might mention names to illustrate, pro and con, but that would be invidious. It is evident, however, that some ornithologists are too enthusiastic and "see things where they ain't," others are too credulous and lend the weight of their belief to statements that otherwise would get no hearing. Some are pundits and can not resist at least once in a while attempting to put something over by the sheer force of their authority—"If I say it's *tropicus* it is *tropicus*." Others are just plain run-of-the-mine bird students trying their best to learn correctly and record aright, and their word alone is as good evidence as can be obtained. The nature of these men is such that anything they seriously record will be based on critical investigation. Integrity and exactitude they have—all that is required.

Again let the writer say that he knows there are many questions that can not be settled without resort to specimens, or without collecting additional material, but that is not admitting that entries can not properly be made in a local list without specimens to back them up. When making bird lists for publication,

he long carried a collecting pistol with which to bring to hand any *Empidonax* that would not tell its name, any thrush whose persistent skulking in the shadows prevented identification, or any apparent rarity. The writer well knows that many a female redstart or yellowthroat, seen in the play of light and shade, has been mistaken for something else until shot and retrieved. But ornithologists of integrity do not list merely glimpsed birds; they record species only when they have studied them enough to be sure. If not prepared to take specimens, they will leave the small sandpipers, warblers in fall plumage and other uncertainties to the collector. But that is not to say that their sight records are valueless. In truth records not backed by specimens make up the bulk of all that is said about habits, migration and local distribution in our ornithological publications. Why insist on a specimen as the sole criterion for admission of a species to a list when as a rule most of the information given about that same species is not based on specimens?

The writer wishes to contend against any urge there may be toward the resumption of general collecting. That practice has had its day in skin, as well as in egg, collecting. The need still acutely felt for certain material proves that general collecting does not satisfy specific wants. What is required is specialized collecting intelligently planned to bring just what is needed.

Collecting is necessary in the training of those who intend to go deeply into ornithology, but not for the average observer or field-glass ornithologist. If collecting birds ever attained the popularity that once attached to oologizing and attracted as numerous disciples, keen on long series of specimens, it might have a very serious effect upon some of the less common birds.

Insistence in collecting everything also might well have results harmful to

the avifauna, regarded strictly as an object of scientific research. It might help to keep rare species in that state or even contribute to their extirpation. It might interfere with extension of range of uncommon forms by killing off the pioneers. It might prevent the establishment of mutants (such as Townsend's bunting probably was) or the development of new forms by hybridization (such as those between *Vermivora pinus* and *V. chrysoptera*).

For the welfare of ornithology itself, collecting can be abused; it should have a proper place but need not be exalted into an indispensable adjunct to the compilation of authentic local lists. So far as species are concerned, in very many cases, the requirement that inclusion be based exclusively on collected specimens is absurd.

In closing the writer would say that he submitted the first draft of this paper to ornithological friends and was surprised to find that it was considered an attack on the validity of collecting. It was not so intended and has been modified in an effort to make clearer its message as summarized in the preceding paragraph. At the same time it should be realized that high ideals and conservative practices must be adopted if collecting is to be prevented from falling farther out of grace. The writer can no more agree with the collector who thinks that all the ivory-billed woodpeckers, for instance, should be collected and preserved in museums, than with the sportsman who thinks that the plovers and prairie chickens can not be perpetuated and that the gunners might as well have the fun of killing them. Ornithologists must in some degree love birds, naturalists to some extent must revere nature, and their feelings in those respects should make them defenders of threatened species, which can be preserved, if at all, by the best protection we can give them in their native environments.

BOOKS ON SCIENCE FOR LAYMEN

SIMPLE AS WALKING?¹

INCREASING numbers of young men are learning to fly. In 1939 the Civilian Pilot Training Program was inaugurated by the Civil Aeronautics Administration as an experiment in the training of civilian pilots through educational institutions. Many thousands of pilots have been trained. At present this program is a part of the war effort to secure and train flyers for the military services. Aviation leaders predict that after the war there will be a tremendous increase in civil flying and that learning to fly will be as easy and simple as driving an automobile.

Cloyd P. Clevenger, pilot and flying instructor for 23 years, maintains that flying is as simple as walking if one will only take the time to learn it properly. He has crystallized his own experience in "Modern Flight" to tell the student in simple words how to fly, from the time he first steps in an airplane through the elementary, intermediate and advanced stages. The book is intended for one who is actually learning to fly, who has an airplane and instructor, and parts of the book are addressed to the instructor. The book is a guide book for supplementary reading during actual instruction.

The book is written around the small civil airplane or primary trainer. It is not claimed that one can learn to fly by merely reading the book. Air-minded persons as well as armchair pilots will, however, find the book interesting reading, and even those who question whether the process is as simple as walking may find a vicarious thrill in studying the instructions and drawings.

HUGH L. DRYDEN

¹ *Modern Flight*. Cloyd P. Clevenger. Illustrated. ix + 294 pp. \$2.95. 1941. Noble and Noble.

OUT OF THE TEST TUBE¹

QUITE possibly the chemist never lived who was more enthusiastic than Professor Holmes about his subject. Enthusiasm is notoriously contagious, and the unique style of this author goes a long way toward making his book a success. Especially noteworthy are the chapters "The Fall of the House of Uranium" and "Silks and Cellulose." The returns which may be expected from adequately directed research are effectively exemplified by indigo and novocaine. Much of the book is so good that one regards it with a feeling of regret that time was not taken to make it very much better. For it is marred by a superficiality which is all too frequently apparent. The case for chemistry (and for its endowment) is sufficient without embellishment. But, like the Norwood builder, Professor Holmes attempts to improve an already perfect case.

On page 44 we are told of a "very considerable cooling of the lungs caused by evaporation of ether." Surgeons do indeed refuse to use ether under certain conditions, but the reason is pharmacological rather than physico-chemical. First, it may be noted that if the cooling effect were of any significance, the preceding heating effect would be even more severe, inasmuch as the rate of condensation of ether during anesthetization is greater than the rate of vaporization after the ether mask has been removed. That the quantity of heat is small can be seen from the concentration of ether in the blood during anesthesia (0.15 per cent.) and the latent heat of vaporization (90 calories per gram). It is in fact negligible compared with the heat abstracted from the lungs by the vaporization of water during normal respiration.

¹ *Out of the Test Tube*. Harry N. Holmes. 3rd ed. Illustrated. 305 pp. \$3.00. 1941. Emerson Books, Inc.

It probably makes no iota of difference to the layman, but (p. 18) it was Berthollet, not Berthelot, who flourished in the eighteenth century and pioneered in the study of chlorine. But our informed layman will be positively pained, after being good-naturedly scolded (p. 151) for saying "nitrocotton" instead of "cellulose trinitrate," to find the author indulging in terms such as "prussic acid gas" and "nitroglycerine." And many readers will describe recent uses of tear gas against "mobs" by adjectives other than "merciful."

The achievements of E. I. du Pont de Nemours and Company are many and notable, but *waterproof* Cellophane (p. 154) is not among them.

Any one attempting to preserve the aroma of his ground coffee for many weeks by adding oat flour (p. 196) will be disappointed, as the deterioration of the aroma depends on factors in addition to the oxidation of coffee-oil; notably the polymerization of furfuryl mercaptan.

It is of course impossible to state categorically that the book was consciously intended as an advertisement; one can only say that if it had been so intended, its contents would have been much the same. A number of passages might be quoted in support of this contention, but one (p. 282) must suffice: "The social benefits of ownership of attractive homes by more millions of people will be great. Home life will be more attractive, an interest in beauty everywhere will be fostered, and communism will be discouraged."

THOMAS B. GRAVE

THE LIFE OF A TELESCOPE MAKER¹

JOHN ALFRED BRASHEAR is probably best known as a maker of astronomical

¹ *John A. Brashear*. H. A. Gaul and R. Eisenman. viii + 220 pp. \$2.25. 1940. Pennsylvania Lives Series.

instruments, but he was more than a mere technician; he was a man who helped to mold thought not only in the field of astronomy but also in the field of education.

His life could never have been lived in any other country except the United States, for he was born in circumstances which made it very improbable that he could attain to as high a station as he held. It is seldom that any man without even an ordinary school education can become an outstanding figure in any scientific field and certainly very few aside from Dr. Brashear have ever attained the distinction of heading a university. He started out as a mechanic, but because of his interest in astronomy, decided to make a telescope. With this as a start, he interested others in astronomy and began to make telescopes for others. Fortunately, several businessmen, among them Andrew Carnegie and William Thaw, became interested in his work and helped him in the establishment of his instrument plant. Never a good business man, with their help he made a business success.

The authors have succeeded in portraying him as a person of wide interests and unusual ideals. Rarely does a scientist have as sympathetic biographers. If all the books in the "Pennsylvania Lives" series succeed in doing as excellent a piece of work as has been done here, the series as well as this one volume will be a great contribution to American biography.

D. B. YOUNG

BEHAVIOR OF THE ADOLESCENT¹

IN 1932 the Progressive Education Association set up a Commission on Secondary School Curriculum, in an attempt to clarify and think through some of the basic problems of secondary education. In addition to various commit-

¹ *The Adolescent Personality*. Peter Bloch. xiii + 517 pp. \$3.00. 1941. D. Appleton-Century Company.

tees organized under the commission to study the subject-matter of the curriculum itself, there was also established the Study of Adolescents, which concerned itself with the understanding of adolescents themselves, in their life outside as well as inside the school and in their personal and social contacts. This committee engaged the services of experts in many fields—educators, psychologists, psychiatrists, physicians, social workers, even sociologists and anthropologists. For nearly ten years it has been busy, studying young people from their entrance into junior high school on through the four years in college. The groups studied have represented a wide range of socio-economic, cultural and geographical status; out-of-school youth were studied also; and, recognizing that the adolescent is not a species sui generis, the individual's early life and family history were also investigated.

The results of this most intensive investigation of adolescence ever undertaken are beginning to appear. This book is one of them. From over 600 cases it has taken two, which are presented in considerable detail. We have here extensive case histories of Betty and Paul, including verbatim reports of interviews with the subjects themselves. The material is interpreted and correlated, and on the basis of its findings the author develops a theory of adolescent development, which he then tests upon two other cases, young people who were out of school and at work. The final section is devoted to a brief discussion of education and adolescence.

Though the material uncovered by these studies is not new to the psychologist, there is much in it that will be new and startling to the average teacher, unaccustomed to peering behind the mask of Paul's or Betty's behavior to find the motives actually prompting it; and to the average parent as well, who prefers to forget his own adolescent conflicts,

even though all too often they are guiding his reactions to his young son or daughter. The fact that adolescence brings little new, but reawakens old emotions and conflicts whose roots are in infancy; that the adolescent's behavior, no matter how far fetched it may seem, is but an individual's response to a need; that the parents play an all-important part in shaping the child's personality, and that, too, in his earliest childhood—these things are yet far from being generally known or accepted.

In these days of mass education and departmentalized instruction, to envisage a handling of adolescents as individuals may seem too much to ask of the school. Yet studies such as this make it abundantly clear that, whether we are aware of it or not, it is by and through his personal contacts, with other adolescents, with teachers and other adults, that the youth grows and develops, and is finally enabled to leave childhood behind. Such contacts determine not only his general adjustment but his interests and learning ability as well. In short, the adolescent is an individual, more acutely aware of himself as such than he ever was before or will be again. And only when he is understood and handled on the basis of his particular personality and his individual needs, does he have a chance to develop the best that is in him.

Whether one agrees with all the author's deductions or not—and this reviewer certainly agrees with most of them—this section of the Commission's investigations is well served by Dr. Bloss' careful study. The next few years will probably see a drastic curtailment of such educational activities as those represented by the Commission; it is good that we already have such studies as this, which may well be a part of the blue prints for the reorganization of our educational theory and practice which is bound to take place after the war.

WINIFRED RICHMOND

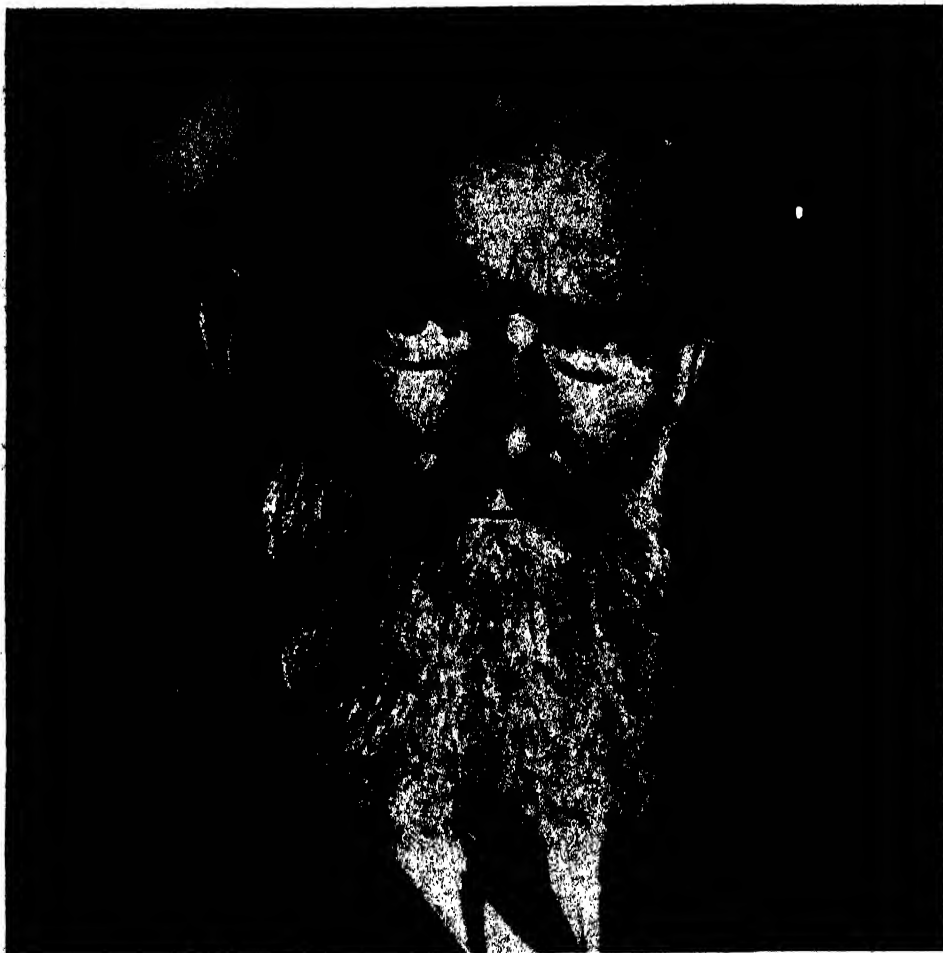

ROBERT BOSCH

German industrialist and manufacturer of the magneto bearing his name, who died on March 13 at eighty-one years of age. The son of a farmer in Abeck, he came from rugged Swabian stock. Dr. Bosch, who opened a small shop half a century ago, became known as a manufacturer and inventor of magnetos, spark plugs, lamps, horns and oil pump devices. His company had branches all over the world and his German plants probably employed 25,000 workers before the outbreak of the present war. In 1906 he introduced the forty-four hour week in his factories and his wages were 60 per cent. higher than those paid elsewhere. This preceded by eight years the introduction of the five dollar minimum scale of Henry Ford. He received his initial technical training at the age of twenty-three when he visited this country and worked with Thomas A. Edison. In 1901 he developed the Bosch magneto and Bosch lamp, which were the foundation of his world-wide reputation. Nine years later he gave \$250,000 to the Stuttgart Technical High School for scientific research; in addition to other millions donated to public welfare projects he gave \$5,000,000 for building a canal in the Neckar River.

THE PROGRESS OF SCIENCE

THE ANNUAL MEETING OF THE NATIONAL ACADEMY OF SCIENCES

THE seventy-ninth annual meeting of the National Academy of Sciences was held on April 27 and 28, 1942, at the Academy building in Washington, D. C. Because of the war, the meeting was attended by Academy members only and was limited to a discussion of the structure of the Academy in its relation to the government as adviser on problems in science. One hundred and seventeen members were present and participated in a general discussion of the activities of the Academy directed to the mention of a wide range of technical problems on behalf of the government. Many of these problems are confidential in nature and are so treated by the scientists engaged upon them.

The general relation of the National Academy of Sciences, of the National Research Council and of other groups, more recently established by Executive order, to the government were described informally by Dr. F. B. Jewett, president of the Academy, following an analysis made recently by him and published by the Institute of Radio Engineers.

Civilian participation in one way or another in the solution of military problems has come to be taken for granted. It was first given official recognition in the United States when the National Academy of Sciences was incorporated in 1863 by an Act of Congress. The charter of the Academy requires that whenever called upon by any department of the Government, it shall investigate, examine, experiment, and report upon any subject of science or art, the actual expenses of such investigations, experiments, and reports to be paid from appropriations which may be made for the purpose, but the Academy shall receive no compensation whatever for any services to the Government. The Academy is, therefore, recognized as a continuing official adviser to the Federal Government and it must attempt to answer such questions of a scientific or technical nature as are officially submitted to it by members of Government Departments. A permanent channel of commu-

nication was thus created, but power to initiate traffic over it resides with the Government and no auxiliary machinery was created whereby the Academy or any other civilian agency might take the initiative in bringing before the Government matters of scientific importance.

Less than a year prior to the entry of the United States into the first World War, a significant step was taken designed to facilitate the use of the channel of communication between the Government and the National Academy. In 1916 the National Research Council was created by President Wilson, and a little later was to play a part in focusing civilian effort on the military problems then arising. The National Research Council was, and is today, a subsidiary of the National Academy of Sciences and, like the Academy, is largely an advisory body only and awaits the assignment of problems by one or another branch of the Government before it can seriously go to work. Moreover, the Council, like the Academy, is not in possession of free money, a corporate laboratory, and other research facilities and is, therefore, not well constituted to conduct research work on any extensive scale.

We turn our attention, therefore, to another agency contemporaneous with the National Research Council, which was created for the express purpose of establishing cooperative effort between military and civilian groups, and which was provided by Congress with funds necessary to create research facilities and to operate them when once created. This agency is the National Advisory Committee for Aeronautics, commonly known as the NACA. The law which created the Committee provides that it shall "supervise and direct scientific study of the problems of flight, with a view to their practical solution," and also "direct and conduct research and experiment in aeronautics." The Committee is composed of fifteen members, including two representatives each of the War and Navy Departments. Throughout its more than twenty-five years of existence, the NACA has given ample testimony of the fruitfulness of cooperation between military and civilian groups, and moreover has provided a prototype as to an organizational arrangement for effecting such cooperative effort successfully.

When, some two years ago, the group to whom I have already referred became convinced that broader participation by civilian scientists in the whole military program was likely to be essential, they regarded the NACA as typifying the

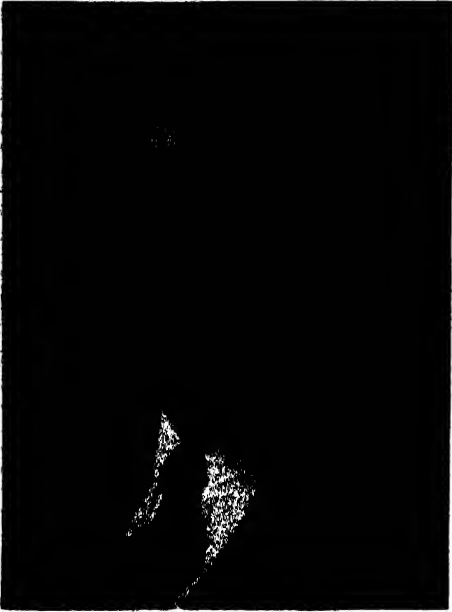

DR. FRANCIS D. MURNAGHAN
PROFESSOR OF APPLIED MATHEMATICS, THE JOHNS
HOPKINS UNIVERSITY.



DR. ALBERT EINSTEIN
PROFESSOR OF MATHEMATICS, INSTITUTE FOR AD-
VANCED STUDY AT PRINCETON.

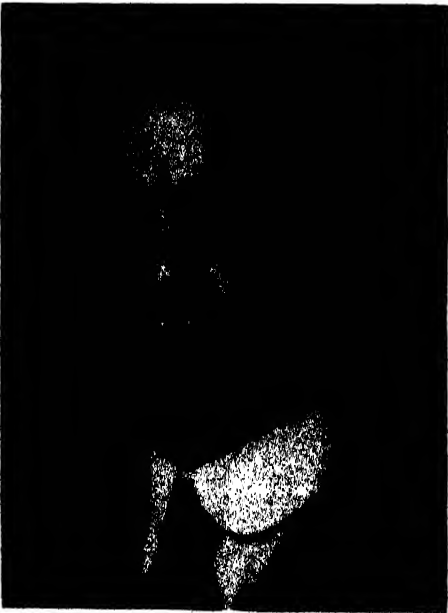

DR. LYMAN J. BRIGGS
DIRECTOR, THE NATIONAL BUREAU OF STANDARDS.



DR. JOHN GAMBLE KIRKWOOD
PROFESSOR OF CHEMISTRY, CORNELL UNIVERSITY.



DR. JOHN T. TATE
PROFESSOR OF PHYSICS, UNIVERSITY OF MINNE-
SOTA, MINNEAPOLIS.

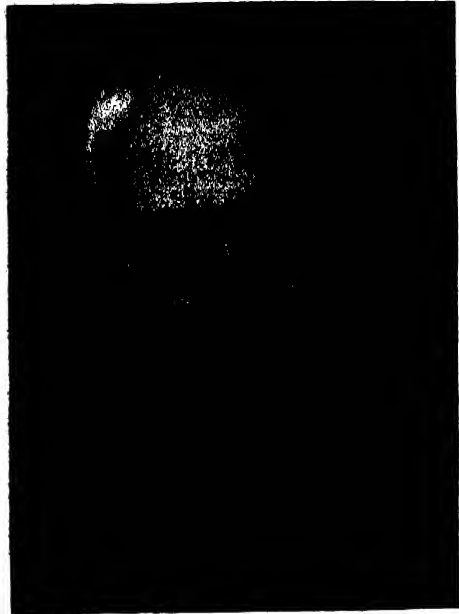

DR. HOMER ADKINS
PROFESSOR OF ORGANIC CHEMISTRY, UNIVERSITY
OF WISCONSIN.

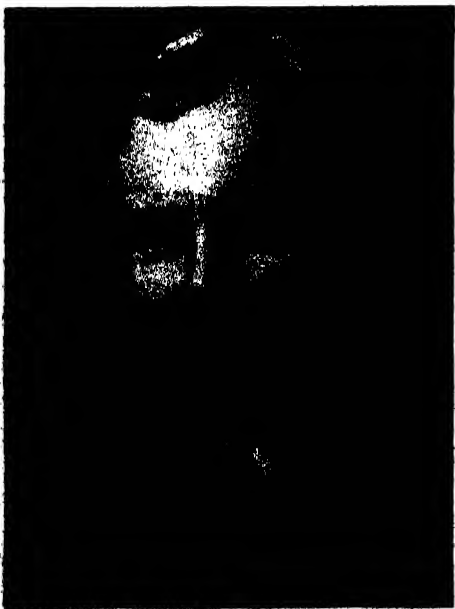

DR. PAUL D. MERICA
VICE PRESIDENT AND DIRECTOR, INTERNATIONAL
NICKEL COMPANY, NEW YORK.

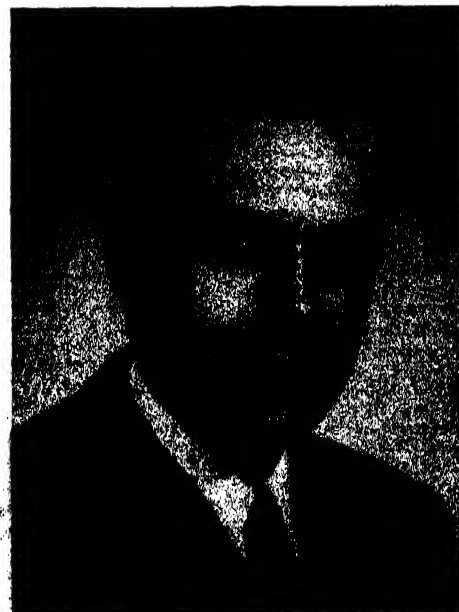

DR. C. A. ELVEHJEM
PROFESSOR OF AGRICULTURAL CHEMISTRY, UNIVER-
SITY OF WISCONSIN.



DR. H. T. CLARKE
PROFESSOR OF BIOCHEMISTRY, COLUMBIA UNIVERSITY.



DR. MICHAEL HEIDELBERGER
ASSOCIATE PROFESSOR OF BIOCHEMISTRY, COLUMBIA UNIVERSITY.

sort of organization they would like to see created. A plan was therefore drawn up envisaging a Committee composed in part of civilian scientists and in part of Army and Navy representatives. On the one hand, the Committee was charged with a broad study of the materials of warfare and, on the other, it would recommend and, if possible, initiate such research as it believed to be in the national interest.

The NACA was created in 1915 by an Act of Congress. The somewhat duplicative plan just referred to was submitted to President Roosevelt about a year and a half ago for such action as he saw fit to take. The proposal appealed to him and he decided to create the Committee by Executive Order. This Order established the Committee as a division under the Office for Emergency Management and confers upon them power to take the initiative in many scientific matters which they believed to have military significance. It also directed the Committee to develop broad and coordinated plans for the conduct of scientific research in the defense program, in collaboration with the War and Navy Departments; to review existing scientific research programs formulated by these Departments, as well as other agencies of the Government; and advise them with respect to the relationship of their proposed activities to the total research program. Moreover, and this is especially important, the Order directs them to initiate and support scientific research on the mechanisms and devices of warfare with the object of improving present ones and creating new ones.

The Order contemplated that the Committee would not operate in the field already assigned to NACA nor in the advisory field of the National Academy of Sciences and National Research Council. Parenthetically it might be noted that in this latter field the Academy and Council are currently engaged on advisory work for the Government for which the out-of-pocket expenses alone are at the rate of much more than \$1,000,000 a year. A recent count shows that the present personnel of Academy and Research Council advisory committees runs to about 225. These figures will give an idea of the vital part which these fact-finding groups are playing in the present emergency.

In June, 1940, the National Defense Research Committee, more familiarly known as the NDRC, was born. It was constituted of eight members, two of these being high-ranking men from the Army and Navy respectively, five more being civilians well known for their experience in organizing and directing both fundamental and applied scientific research, and, as an eighth member, the Commissioner of Patents.

The Executive Order creating the NDRC

omitted any reference to the biological sciences, and, in particular, to the medical sciences. However, during its first year of operation, experience accumulated to the effect that a broader program of attack would not only be useful but was, in reality, urgently demanded. This realization prompted a second approach to President Roosevelt, with the result that in June of last year he created two new functional groups. One of these was the Committee on Medical Research, to explore its indicated territory in the same manner that the NDRC had been exploring the physical sciences. Then, over and above both the NDRC and the Committee on Medical Research, there was placed the Office of Scientific Research and Development, usually referred to as OSRD. This latter office was placed in charge of Dr. Vannevar Bush, who until then had been Chairman of the NDRC. President Conant, of Harvard, was then made Chairman of the NDRC and Dr. Newton Richards, of the Medical School of the University of Pennsylvania, was made Chairman of the CMR.

In order to insure complete coordination of civilian and military research and development, Dr. Bush, as Director of OSRD, was provided with an advisory council consisting of the Chairmen of NDRC, CMR, and NACA; the Coordinator of Naval Research, and the Special Assistant to the Secretary of War performing a somewhat similar function in that service.

The Executive Orders creating these various committees naturally had to leave indeterminate the question of financial support. They are all subsidiary to the Office for Emergency Management and, like this Office, must look to Congress for the necessary operating appropriation. Thus far the appropriations, while not munificent, have been adequate. During its first year of existence the NDRC authorized research projects which totaled about ten million dollars. At the beginning of its second year, it was granted another ten millions and this was recently augmented by several millions more. To be more specific, the OSRD, during its first year of existence, will guide the expenditure of about twenty millions throughout the whole scientific field.

The relations thus sketched by Dr. Jewett were described in greater detail by Academy members and steps were suggested for rendering the Academy more effective in its service to the Government during the present emergency and thereafter.

At the Tuesday morning session the



DR. THOMAS MIDGLEY, JR.
VICE PRESIDENT, ETHYL GASOLINE CORPORATION.

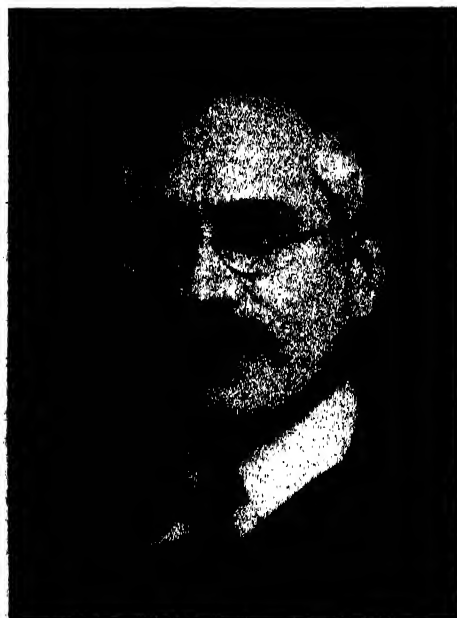

DR. S. A. WAKSMAN
MICROBIOLOGIST, NEW JERSEY AGRICULTURAL EXPERIMENT STATION.



DR. RALPH E. CLELAND
PROFESSOR OF BOTANY, INDIANA UNIVERSITY.



DR. C. H. DANFORTH
PROFESSOR OF ANATOMY, STANFORD UNIVERSITY.



DR. E. D. TYZZER
PROFESSOR OF COMPARATIVE PATHOLOGY AND
TROPICAL MEDICINE, HARVARD MEDICAL SCHOOL.



DR. ALFRED M. TOZZER
PROFESSOR OF ANTHROPOLOGY, HARVARD UNIVER-
SITY.

annual elections were held with the following results:

Foreign Secretary: Walter B. Cannon, Harvard Medical School, Boston, Massachusetts (to succeed L. J. Henderson, deceased).

Members of the Council: For a term of three years commencing July 1, 1942.

A. N. Richards, Medical School of the University of Pennsylvania, Philadelphia, Pa. (to succeed himself).

G. W. Conner, Department of Embryology, Carnegie Institution of Washington, at Johns Hopkins University, Baltimore, Md. (to succeed C. A. Kraus, of Brown University, Providence, R. I.).

Foreign Associate: Robert K. S. Lim, Peiping Union Medical College, Peiping, Kweiyang, Kweichow Province, China.

Dr. Albert Einstein, who was elected foreign associate of the Academy in 1922 as a German subject, became an Ameri-

can citizen in 1940. In recognition of this change in status he was elected a member of the Academy, but with the understanding that his title of foreign associate shall not be disturbed by this action. Fifteen other men, whose portraits also accompany this report, were elected to membership.

At its meetings the National Academy made the following awards: the Mary Clark Thompson gold medal with bronze replica to Sir Arthur Smith Woodward, the distinguished British paleontologist; the Daniel Giraud Elliot gold medal with bronze replica for 1935 to Edwin H. Colbert, of the American Museum of Natural History; the Daniel Giraud Elliot gold medal with bronze replica for 1936 to Robert Cushman Murphy, of the American Museum of Natural History.

F. E. WRIGHT,
Home Secretary

A BRAZILIAN ORIGIN FOR THE COMMERCIAL OIL PALM

THE traditional name "African oil palm" may be misleading, like "Irish potato" and "Jerusalem artichoke." It is known that the oil palm was taken from Africa to the West Indies in the seventeenth century, whence the species was called *Elaeis guineensis*, but an earlier transfer from Brazil to the Portuguese slave-trading settlements in Africa is indicated. The palm grows spontaneously along the coast of Brazil and belongs to the coconut family. All the allied genera are natives of South America. The closely related Panama oil palm, *Alfonsia oleifera*, is compared and illustrated in the *National Horticultural Magazine* for January, 1940.

Elaeis is a handsome, middle-sized palm growing well in southern Florida and producing dense clusters of oval, plum-like fruits. A yellow oil, tasty and wholesome in the fresh state, is obtained from the pulp of the fruits, while the kernels yield a colorless oil, much like

coconut oil. West Africa and the East Indies supply most of the palm oils for the United States, amounting to 800,000 tons. A special use of *Elaeis* oil is in the manufacture of tin-plate. The plea of European nations for a "place in the sun" is chiefly to obtain rubber and vegetable oils.

The introduction to Jamaica, "In Tubs Watered by the Way," as noted by Hans Sloane in 1688, apparently had occurred several years earlier, a full century before Captain Bligh's more famous mission to bring the breadfruit from Tahiti, interrupted by the mutiny on the *Bounty*. The oil palm and the breadfruit now are scattered through the West Indies, but seldom used. The normal inertia of food habits would account for the breadfruit not being adopted by the Negroes, but not for their failure to welcome palm oil, if they had known it in Africa. An aversion would be explained if they met with palm oil on the slave

ships, and had to eat it in a rancid state.

The first unequivocal account of *Elaeis*, in Bauhin's "Historia Plantarum Universalis," 1650, was from the Gold Coast, where the Portuguese had possession for 160 years, from 1482 to 1642,



MATURE FRUITS
NEARLY NATURAL SIZE.

then the Dutch, later the British. Earlier references to palm oil have been associated with *Elaeis*, but may relate to local palms with similar oils. Bauhin described a palm called "ady," at San Thome, doubtless *Borassus* or *Hyphaene*, with very tall, smooth, swollen trunks, inflorescences tapped for wine, and large

yellow fruits yielding a yellow oil that the natives used for seasoning their food and shining their skins.

Early utilization of *Elaeis* in Brazil may be reflected by Nieuhoff in "Pinker-ton's Voyages," recounting the struggles between the Dutch and the Portuguese, from 1640 to 1649. Cassava and oil were noted among food supplies of beleaguered settlements. In a garden at Pernambuco, then a Dutch colony, were "near seven hundred cocoa trees of all sizes, some of them thirty, forty and fifty feet high which being transplanted thither out of the circumadjacent countries bore abundance of fruits the very first year." Palms with large trunks transplant better, presumably from storing more moisture. Brazil has many wild cocoid palms, but only *Elaeis* would promise a food return to warrant so much labor.

An early Portuguese cultivation in Angola is intimated in Monteiro's "Angola and the River Congo," 1876, at a long-abandoned missionary settlement where "plantations of coconut and oil-palm trees, groves of oranges, lemons and other fruit trees," had been established. The use of tree crops apparently had spread among the natives along the Quanza River, "a delicious panorama of mile after mile of the most beautiful dark forests of high, feathery-topped oil palms," sheltering native huts.

Richard Burton, in "The Lake Regions of Central Africa," 1860, reported the discovery of Lake Tanganyika and a wealth of oil palms. "*Elaeis guineensis* . . . springs apparently uncultivated in large dark groves on the shores of Tanganyika, where it hugs the margin, rarely growing at any distance inland." Several writers have quoted this statement without noting that Burton in "The Lands of Cazembe," 1873, withdrew his identification of the palm. "I found a species on the Tanganyika Lake which produced good oil but the fruit

was like a bunch of grapes, not a spike, as on the West African coast and about Bahia." The fruit was "a bright yellow drupe with shiny purple-black point," indicating the *Raphia* palm. Burton's later work includes the diary of the "Pombeiros," the indentured peddlers who were the first Europeans to cross the African continent, at the beginning of the nineteenth century. As with later explorers, food was a critical question, but no oil palms were noted. Palm oil was mentioned once, not as a local product, but as received at Cazembe from a tributary people in the region of Lake Tanganyika.

In Schweinfurth's "Heart of Africa," *Elaeis* is reported among the Monbutto people, a primitive cannibal tribe in the valley of the Welle River, a northern tributary of the Congo, visited in 1870. "All of their food is prepared by a mixture of oil from the oil palm." Schweinfurth was an eminent botanist, but no distinctive feature of *Elaeis* was noted, while *Raphia* was found in great abundance. Later explorers report *Raphia* oil in extensive use among the natives on the lower reaches of the same river.¹

The three oil-yielding African palms, *Raphia*, *Borassus* and *Hyphaene*, are widely distributed, from Senegal to Mozambique, the first in swamps or water-courses, the others in dry, open country. A natural habitat for *Elaeis* has not been recognized. The forest canopy of the coast belt in Liberia and neighboring regions of West Africa is close and continuous, with little undergrowth and no true forest palms except the climbing rattans. The uncut forest does not burn, no humus blanket being formed, the fallen leaves and branches being promptly eaten by termites.

In addition to the oil, some of the tribes obtain palm wine, fiber and building materials from *Elaeis*, while neigh-

¹ E. Autran, *Ann. Mus. Col., Marseille*, 1824.



FRUIT CLUSTER
SURROUNDED BY LEAF BASES.

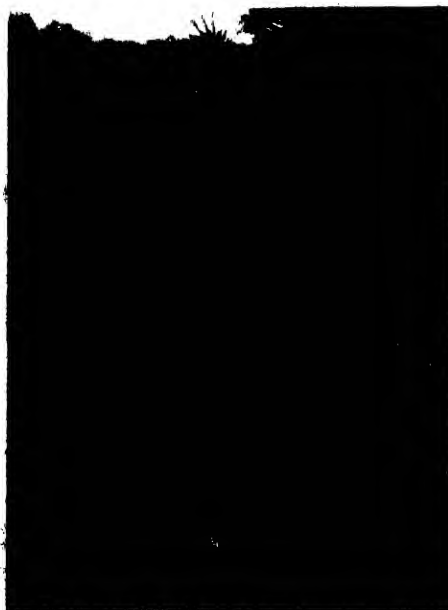

MATURE OIL PALM
GROWING IN NORTHERN HAITI.

boring peoples may have no palms, or only a few. Many missionary settlements, trading posts and colonial stations have established where oil palms are planted and the seeds scattered. The ripe fruits often are carried by the natives as a travel ration, and the seeds thrown aside along the pathways. The seedlings become established in open places, and resist fire. An indigenous palm with the habits and uses of *Elaeis* probably would have spread across the continent, even in prehistoric times, in-

stead of being so largely restricted to West Africa.

Palm oil is eaten largely with cassava, another Brazilian crop that has spread gradually through tropical Africa, as have maize, tobacco, peanuts, pineapples, papayas, guavas and other food plants that undoubtedly came from America. Several products of American origin now are supplied commercially from the eastern hemisphere, as rubber, quinine, cocaine, cacao, tapioca and cashew-nuts.

O. F. Cook

EXCAVATION OF ANCIENT METEOR CRATERS IN TEXAS

EXCAVATIONS at the site of three prehistoric meteor craters nine miles southwest of Odessa, Texas, are attracting geological experts and students as well as curious tourists to the sand-hill dotted prairies in the western part of the state.

Recent discovery of two new craters adjacent to the giant pit, which has been under exploration for two years by field crews from the University of Texas, with the assistance of the Work Projects Administration, has heightened interest in the study of the phenomenon.

All three meteors are believed to have crashed to the earth about 40,000 years ago, their terrific speed resulting in a concussion much greater than those caused by the huge bombs of modern warfare.

The main crater, second largest in the United States, has been studied and explored since 1939. Resembling a giant crawfish hole, it is about 500 feet in diameter at the surface and 50 feet deep. The meteor itself, according to Dr. E. H. Sellards, director of the Bureau of Economic Geology of the University of Texas, who is in charge of the project, is believed to be about 164 feet below the bottom of the crater.

One of the newly discovered craters is 70 feet in diameter and about 17 feet deep, and contains as many as "six to seven thousand meteorites with a total

weight of about six tons." The theory is that the crater was caused by a closely packed swarm of small meteors, rather than by a single mass breaking into thousands of pieces as it struck.

The other pit is similar in formation but smaller. Since the two new craters were discovered early in September, there has not been time to make an exhaustive study.

Under the direction of Dr. Sellards and Glen Evans, assistant, 35 exploratory drill holes have been put down in and near the main crater. Observations have also been made from additional trenches cut at the sides, and from core drilling.

An elevator shaft is now being sunk in the center of the crater. When it is completed visitors will have an opportunity to actually see the meteor fragments. Present plans are to maintain the site as an educational exhibit open to the public, when excavations are completed.

From observations of the main crater, it has been found that rock strata from as deep as 70 feet was thrown to the surface by the impact of the meteor, that all rock strata in and immediately around the crater were moved from their original positions, and that rock strata forming the crater walls were lifted, broken, folded and faulted.

On the surface the rock debris is

chiefly blocks of limestone often covered and cemented together by caliche. Pits and trenches cut outwards from the rim show that large blocks of shales are included with the limestones. Search among the rock debris enables one to recognize rocks coming from various parts of the geologic section of this locality down to about a depth of 70 feet. The largest of the limestone blocks are three or four feet across. Some of the shale masses are of equal size and larger. Many of the limestone boulders have disintegrated, and the shale persists only when protected by overlying debris. At some places a secondary accumulation of caliche cements the ejected rock, indicating considerable length of time since the crater was formed and the rock thrown out. The maximum thickness of the debris around the rim is now 10 or 12 feet.

At the present time the crater is filled within five or six feet of the level of the surrounding plain. The latest fill consists of fine red incoherent silt with some fine sand. The stratum is lens-shaped, having a thickness of 25 to 30 feet at the

center and thinning out to the margins. Some of the sediments are of a degree of fineness such as to indicate that they probably settled from the atmosphere slowly, while the others are coarser and were probably windblown. This stratum of silt and windblown sand, with few pebbles and little or no caliche, readily separated throughout the entire crater from the older, more consolidated and more or less calichified underlying sediments.

Next underlying the silt is a stratum lighter in color which consists in part of silt with which is included pebbles and pieces of rock washed in from the rim of the crater. Caliche has formed in this stratum, resulting in partial cementation. In the central part of the crater this material is 45 to 50 feet thick. The definite line of separation between this and the overlying stratum, together with the difference in texture and origin, suggest that an appreciable time interval separates them.

Some of the rock thrown out by the meteor fell back into the crater. In the



AERIAL VIEW OF THE WEST RIM OF THE METEOR CRATER AT ODESSA
EXCAVATORS BELIEVE THAT THE CRATER WAS CAUSED BY A CLOSELY PACKED SWARM OF METEORS.
THE PICTURE WAS TAKEN FROM A HEIGHT OF ABOUT 175 FEET.

central part of the crater this stratum of fragmental rock at the bottom of the crater is 10 or 15 feet thick and is readily distinguishable from finer materials above and below.

Immediately below the fragmental rock there is a stratum which is known as rock flour. In this zone the sand grains were completely shattered by the meteor so that when rubbed they remain only as a coating on the hand. The rock flour is thickest near but somewhat northeast of the center of the crater. From its place of maximum thickness it thins in all directions, forming a lens lying within and not extending to the margins of the crater.

The conclusion reached by Sellards and Evans is that the rock flour is shattered limestone, and that the impact which shattered the sand grains may have been vibration waves.

The land elevation at the crater is near 3,050 feet. The greatest depth at which rock flour was found by drilling is at an elevation of 2946.9 feet, or about 103 feet from the plains surface. The meteorite encountered in drilling lies at an elevation of 2,880 feet, or approximately 67 feet below the lowest known rock flour and about 170 feet from the original surface.

A magnetometer survey, verified by drilling, indicates that the principal meteorite mass or masses lie very nearly under the center of the crater.

The state, through the university, has aided in the cost of supervision, while the WPA has supplied the labor and some supervisory help. The County of Ector has paid the cost of hoist, cable, cage and lumber for construction of the shaft.

J. A. M.

SCIENTIFIC ADVANCE IN GERMANY¹

Prof. Virchow, in his address before the Congress of German Naturalists, states some facts which show what progress freedom of discussion has made in Germany since the beginning of the present century. "Not perhaps at the dead of night, but still beneath the veil of secrecy, a handful of *savants* assembled for the first time at Leipsig, at the invitation of Oken. In fact, in 1822, no considerable body of men could come together in Germany, in answer to a public invitation, with the permission of the civil authorities. They could not discuss among themselves scientific questions, no matter how unconnected with the political and national questions of the day. Add to this that other fact, that, if I am not mistaken, it was only in 1861, at the Congress of Naturalists at Spire, that the names of

Austrian members could be made public, and then we can appreciate the tremendous change that has been brought about in Vaterland." In the same address Dr. Virchow pays a well-earned tribute of honor to French *savants*. He opposes also the suggestion that has been made by certain German professors, that *Brevets*, or honorary members of French Academies, etc., held by German scientific men, should be sent back, for the reason that a distinguished French botanist had recently declined the honor of being made an associate of the Natural Science Academy of Leipsig.

¹ Printed in *The Scientific Monthly* then called *The Popular Science Monthly* for June 1872—70 years ago.

INDEX

NAMES OF CONTRIBUTORS ARE PRINTED IN SMALL CAPITALS

- Age of Homo Sapiens, W. W. HOWELLS, 552
 American Academy of Arts and Sciences, R. S. BATES, 265
 American Association, F. R. MOULTON, 86, 186; Newly Elected President of, W. F. G. SWANN, 184; Prize for 1941-42, E. N. HARVEY, 188
 Ant Behavior in the Face of Obstacles, L. J. LAPLEUR, 467
 Anthropologist in Russia, A. HRDLÍČKA, 269, 308, 397
 Asiatic Survivals in Indian Songs, M. BARBEAU, 303
 Atoms, Forces and, K. K. DARROW, 197
 Ausable Chasm, Evolution of, C. E. RESSER, 29
 BARBEAU, M., Asiatic Survivals in Indian Songs, 303
 BATES, R. S., American Academy of Arts and Sciences, 265
 BLANCHARD, W. O., Soviet Waterways, 320
 BOAS, F., Elsie Clews Parsons, 480
 Books on Science for Laymen:
 Adolescent Personality, P. Blos, 568; Advancing Front of Medicine, G. Gray, 375; America's Last King, M. Guttmacher, 278; Behavior Study of the Common Tern, R. Palmer, 378; Between Physics and Philosophy, P. Frank, 473; Field Book of North American Snakes, R. Ditmars, 183; Four Treatises of Paracelsus, H. Sigerist, ed., 472; Golden Throng, E. Toule, 82; How Your Mind Works, G. Dalrymple, 379; Introduction to Cultural Anthropology, R. Lowie, 182; John A. Brashear, H. Gaul, R. Eiseman, 568; Musk of Sanity, H. Cleckley, 280; Mathematical Logic, W. Quine, 277; Mathematician's Apology, G. Hardy, 81; Mathematics and the Imagination, E. Kasner, J. Newman, 179; Men and Volts, J. Hammond, 179; Meteorology for Aviators, R. Sutcliffe, 180; Modern Flight, C. Clevenger, 567; Neuroses in War, E. Miller, ed., 81; Out of the Test Tube, H. Holmes, 567; Plant Doctor, C. Westcott, 474; Psychiatry for the Curious, G. Preston, 378; Science and Seizures, W. Lennox, 376; Science in a Changing World, E. Cable, others, 277; Science on the March, J. Clark, others, 474; Strange Malady, W. Vaughan, 279; Ten Years in the Congo, W. Davis, 377; Torch of Civilization, M. Luckiesh, 379; Traumatic Neuroses of War, A. Kardiner, 181; Unto the Fourth Generation, I. Simons, 83
 Bosch, Robert, portrait, 570
 Bragg, Sir William, W. F. G. SWANN, 380
 Brazil, Sailing Craft of, E. O. HULBERT, 125
 Camouflage Exhibit, E. D. WALLACE, 484
 Cellulose, Structure of, W. J. LYONS, 239
 CHURCH, J. E., Human Side of Snow, 211
 COCKERELL, T. D., Epic of Yellow Fever, 43
 COHEN, I. B., Heritage of Galileo, 282
 COMPTON, A. H., War Problems of the Physics Teacher, 370
 Compton, Arthur H., W. F. G. SWANN, 184
 Concretions Found in New Jersey, Ancient, 292
 CONSIDINE, D., Instruments and Controls, 455
 COOK, O. F., Brazilian Oil Palm, 577
 Cosmic Rays and Constitution of Matter, Nature of, R. W. LADENBURG, 391
 CRIST, R., Subsistence Manufacturing, 132
 Culture, Values of, M. J. HERSKOVITS, 557
 CUTSHALL, A., Minerals of the Philippines, 295
 DARROW, K. K., Forces and Atoms, 197
 DAVIS, W., Anniversary of Science Service, 290
 DEWING, F., Pasteur: Study in Method, 529
 Donne, John, Science and, O. P. TITUS, 176
 Earth, Bad, S. F. TRELEASE, 12
 EINSTEIN, A., Walther Nernst, 195
 Electron Microscope, New High-Voltage, 389
 FLETCHER, J., Science and Human Values, 259
 Forces and Atoms, K. K. DARROW, 197
 Forests and People, R. F. HAMMATT, 328
 Galileo, Heritage of, I. B. COHEN, 282
 GAMOW, G., Neutrinos vs. Supernovae, 65
 GENGERELLI, J., Facts and Philosophers, 431
 GUDGER, E. W., Swordfishing, 418, 499
 HAMILTON, J., Medical Physics Laboratory, 192
 HAMMATT, R. F., Forests and People, 328
 HARVEY, E. N., American Association Prize for 1941-42, 188
 HASKELL, E., Religious Force of Science, 545
 HERRICK, C. J., Scientific Investigation, 361; Scientific Pioneering, 49; Young Naturalists' Society, 251
 HERSKOVITS, M. J., Values of Culture, 557
 HOLMES, S. J., How Life Becomes Complex, 57
 Homo Sapiens, Age of, W. W. HOWELLS, 552
 HOWELLS, W. W., Age of Homo Sapiens, 552
 HRDLÍČKA, A., Anthropologist in Russia, 269, 308, 397
 HULBERT, E. O., Sailing Craft of Brazil, 125
 Hungary, Estates and Peasants in, G. KISS, 461
 HUNT, F., Your Voice and the Telephone, 138
 Indian Songs, M. BARBEAU, 303
 Instruments and Controls, D. CONSIDINE, 455
 IVES, R., Discovery of Pinacate Volcano, 230
 KELLOGG, C., Scientist and Society, 441, 537
 KELLY, E., Memorial to Marconi, 92
 KISS, G., Estates and Peasants in Hungary, 461
 KLING, W., Vegetable Consumption, 561
 KOVÁCS, R., Physical Therapy, 155

- LADENBURG, R. W., Nature of Cosmic Rays and Constitution of Matter, 391
 LAFLEUR, L. J., Ant Behavior in the Face of Obstacles, 467
 Landed Estates in Hungary, G. KISS, 461
 Leadership, Optimum Ages for, H. LEHMAN, 162
 LEHMAN, H., Optimum Ages for Leadership, 162
 Livestock, Parasitism and, B. SCHWARTZ, 449
 LYONS, W. J., Structure of Cellulose, 238
- MCATEE, W. L., Specimen Fetish, 565
 MACNIDER, W. DEB., Tissue Repair and Resistance: Aging Process, 149; Injurious Agents, 247; Life Processes, 5
 Manufacturing, Subsistence, R. CRIST, 132
 Marconi, Memorial to, E. KELLY, 92
 MARTIN, P., Recent Mogollon Discoveries, 385
 Mathematics Returning, F. R. MOULTON, 487
 Matter, Nature of Cosmic Rays and Constitution of, R. W. LADENBURG, 391
 Medical-Physics Laboratory, J. HAMILTON, 192
 Mescalitan Island, "Queen" of, P. C. ORR, 482
 Meteor Craters in Texas, 580
 MILLIKAN, R. A., Walther Nernst, 84
 Minerals, Philippine, A. CUTSHALL, 295
 Mogollon Discoveries, Recent, P. MARTIN, 385
 MONTAGU, M. A., War and Myth of Nature, 342
 MOULTON, F. R., American Association, 86, 186; Expansion and Diversification of Science, 293; Mathematics Returning, 484
 Music, Artistic Deviation as an Esthetic Principle in, C. E. SEASHORE, 99
- National, Academy of Sciences, F. WRIGHT, 571; Geographic Society, 399; Observatory, Mexico, W. WHIPPLE, 475
 Naturalists' Society, Young, C. HERRICK, 251
 Nature, Nature of War and the Myth of, M. A. MONTAGU, 342
 NEEDHAM, J. G., Student Life in the University of Puerto Rico, 128
 Nernst, Walther, A. EINSTEIN, 195; R. A. MILLIKAN, 84
 Neutrinos vs. Supernovae, G. GAMOW, 65
 New York Zoological Park, F. OSBORN, 382
 Noyes, William Albert, 288
- Oil Palm, Brazilian, O. F. COOK, 577
 ORR, P. C., "Queen" of Mescalitan Island, 482
 OSBORN, F., New York Zoological Park, 382
- PANUNZIO, C., Population Trends in U. S., 353
 Parasitism and Livestock, B. SCHWARTZ, 449
 Parsons, Elsie Clews, F. BOAS, 480
 Pasteur: Study in Method, F. DEWING, 529
 Philippines, Minerals of, A. CUTSHALL, 295
 Philosophers, Facts and, J. GENGEBRELL, 431
 Physical and Non-Physical Worlds and Their Intermediate Elements, G. STROMBERG, 71
 Physics Teachers, War and, A. H. COMPTON, 370
 Population Trends in U. S., C. PANUNZIO, 353
- Progress of Science, 84, 184, 292, 380, 475, 570
 Puerto Rico, Student Life in the University of, J. G. NEEDHAM, 128
- Religious Force of Science, E. HASKELL, 545
 RESSER, C., Evolution of Ausable Chasm, 29
 RIGGS, A. S., Evolution of War, 110
 Russia, Anthropologist in, A. HRDLICKA, 269, 308, 397
- Sailing Craft of Brazil, E. O. HULBERT, 125
 SCHWARTZ, B., Parasitism and Livestock, 449
 Science, Expansion and Diversification of, F. R. MOULTON, 293; and Human Values, J. M. FLETCHER, 259; and John Donne, O. P. TITUS, 176; Religious Force of, E. F. HASKELL, 545; Service, Anniversary of, W. DAVIS, 290
 Scientific, Investigation, C. J. HERRICK, 361; Pioneering, C. J. HERRICK, 49
 Scientist and Society, C. KELLOGG, 441, 537
 SEASHORE, C. E., Artistic Deviation as an Esthetic Principle in Music, 99
 Sky, Evening, 95
 Smithsonian Institution, Engineering and Industries Exhibit of, F. A. TAYLOR, 189
 Snow, Human Side of, J. E. CHURCH, 211
 Solar Radiation and the State of the Atmosphere, H. T. STETSON, 513
 Songs, Indian, M. BARBEAU, 303
 Soviet Waterways, W. O. BLANCHARD, 320
 Specimen Fetish, W. L. MCATEE, 565
 STETSON, H. T., Solar Radiation and the State of the Atmosphere, 513
 STROMBERG, G., Physical and Non-Physical Worlds and Their Intermediate Elements, 71
 Subsistence Manufacturing, R. CRIST, 132
 Supernovae, Neutrinos vs., G. GAMOW, 65
 SWANN, W. F. G., New President of American Association, 184; Sir William Bragg, 380
 Swordfishing, E. W. GUDGER, 418, 499
- TAYLOR, F. A., Engineering and Industries Exhibit of Smithsonian Institution, 189
 Telephone, Your Voice and the, F. HUNT, 138
 Termites, I, V. W. VON HAGEN, 489
 Therapy, Physical, R. KOVACS, 155
 Tissue Repair and Resistance: Aging Process, 149; Injurious Agents, 247; Life Processes, 5, W. DEB. MACNIDER
 TITUS, O. P., Science and John Donne, 176
 TRELEASE, S. F., Bad Earth, 12
- Vegetable Consumption, W. KLING, 561
 Volcano, Discovery of Pinacate, R. IVES, 230
 VON HAGEN, V. W., Termites, I, 489
- WALLACE, E. D., Camouflage Exhibit, 484
 War, Evolution of, A. S. RIGGS, 110; and Myth of Nature, M. A. MONTAGU, 342; and Physics Teachers, A. H. COMPTON, 370
 WHIPPLE, F., National Observatory, Mexico, 475
 WRIGHT, F., National Academy of Sciences, 571
 Yellow Fever, Epic of, T. D. COCKERELL, 43

